

WOOD TRICK

MECHANISMS
SERIES

ENGINEERING
J0000000004



MECHANICAL MODELS & KITS

MYSTERY FLOWER



4 LEVEL

278
Pieces

WDTK045

WOOD TRICK

ENG Attention! **UKR** Увага! **DEU** Achtung! **FRA** Attention!
POL Uwaga! **SPA** Atención! **ITA** Attenzione!



ENG Do not set fire to it! **UKR** Не підпалювати! **DEU** Nicht anzünden!
FRA Ne pas allumer! **POL** nie podpalać! **SPA** No prender fuego! **ITA** Non dare fuoco!



ENG Caution! Sharp parts! **UKR** Обережно! Гострі деталі! **DEU** Vorsichtig!
Scharfe Details! **FRA** Attention Détails tranchants! **POL** Uwaga! Ostre
szczegóły! **SPA** Cuidado! Piezas cortantes! **ITA** Attenzione! Dettagli nitidi!

ENG Recommendation: if you have difficulty in connecting parts, treat toothpicks with paraffin. **UKR** Рекомендація: якщо виникли складнощі при скріпленні деталей, обробіть зубочистки парафіном. **DEU** Empfehlung: Wenn Sie Schwierigkeiten haben, Teile zu verbinden, behandeln Sie Zahnstocher mit Paraffin. **FRA** Recommandation: si vous avez des difficultés pièces de fixation, traitez les cure-dents avec de la paraffine. **POL** Zalecenie: jeśli masz trudności z połączeniem części, obsługiwać wykałaczkę parafiną. **SPA** Recomendación: si tiene dificultades para fijar piezas, trate mondadientes con parafina. **ITA** Raccomandazione: in caso di difficoltà nel fissare le parti, trattare gli stuzzicadenti con paraffina.

ENG The assembling of constructor does not require to use glue. **UKR** Конструктор не вимагає застосування клею. **DEU** Für die Montage des Konstruktors ist kein Klebstoff erforderlich. **FRA** Aucune colle n'est nécessaire pour monter le constructeur. **POL** Montaż konstruktora odbywa się bez kleju. **SPA** El montaje constructor no requiere el uso de pegamento. **ITA** L'assemblaggio non richiede l'uso di colla.

ENG Fragile details! Be careful when removing the constructor from the card! **UKR** Крихкі деталі! Під час вилучення конструктора з карти будьте обережні! **DEU** Zerbrechliche Details! Seien Sie vorsichtig, wenn Sie den Konstruktor von der Karte entfernen! **FRA** Détails fragiles! Faites attention en retirant les éléments de la construction de la carte! **POL** Kruche szczegóły! Przedmioty należy wyjmować z karty ostrożnie! **SPA** Detalles frágiles! Sea prudente al sacar elementos de mecano del tarjeta! **ITA** Dettagli fragili! Gli elementi vanno estratti dalla scheda con cautela!

ENG All elements that interlock must be sanded with sandpaper and greased with paraffin. **UKR** Всі елементи, що входять у зачеплення необхідно зачистити наждачним папером і змастити парафіном. **DEU** Alle eingreifenden Teile müssen mit Sandpapier gereinigt und mit Paraffin eingefettet werden. **FRA** Il faut nettoyer tous les éléments de l'accrochage à l'aide du papier-meri et les traiter avec de la paraffine. **POL** Wszystkie zaczepione elementy należy oczyścić papierem ściernym i nasmarować parafiną. **SPA** Todos los elementos que se enganchan deben limpiarse con papel de lija y engrasarse con parafina. **ITA** Tutti gli elementi agganciati devono essere puliti con carta vetrata e ingrassati con paraffina.

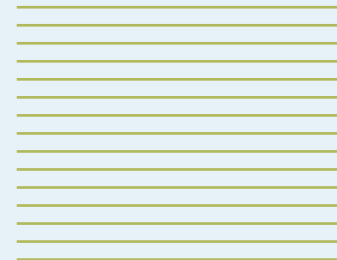

ENG Spare parts. **UKR** Запасні деталі. **DEU** Ersatzteile. **FRA** Pièces de rechange. **POL** Części zamienne. **SPA** Repuestos. **ITA** Pezzi di ricambio.



4



1

ENG Auxiliary tool for assembling or measuring distances. **UKR** Допоміжний інструмент для збірки або вимірювання відстаней. **DEU** Hilfswerkzeug zum Montieren oder Messen von Abständen. **FRA** Outil auxiliaire pour assembler ou mesurer des distances. **POL** Narzędzie pomocnicze do montażu lub pomiaru odległości. **SPA** Herramienta auxiliar para ensamblar o medir distancias. **ITA** Strumento ausiliario per l'assemblaggio o la misurazione delle distanze.

W&D TRICK

ENG Symbolic notations. **UKR** Умовні позначення.
DEU Erläuterungen. **FRA** Légende. **POL** Notacje symboliczne.
SPA Notaciones simbólicas. **ITA** Notazioni simboliche.

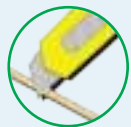

ENG Cut off a toothpick. **UKR** Відрізати зубочистку.
DEU Schneiden Sie einen Zahnstocher ab. **FRA** Couper la cure-dent. **POL** Odetnij wykałaczkę. **SPA** Cortar un palillo de dientes. **ITA** Tagliare lo stecchino.



ENG Break off from both sides. **UKR** Обламати з двох сторін.
DEU Brechen Sie einen Zahnstocher auf beiden Seiten ab.
FRA Casser un cure-dent des deux côtés. **POL** Oblomaj wykałaczkę po obu stronach. **SPA** Romper un palillo de dientes en ambos lados. **ITA** Rompere uno stecchino su entrambi i lati.



ENG Remove burrs. **UKR** Видалити задирки. **DEU** Niedrögel entfernen. **FRA** Enlever les bavures. **POL** Usuń zadziory. **SPA** Quitar rebabas. **ITA** Eliminare le bave.



ENG The part must rotate freely. **UKR** Деталь повинна вільно обертатися. **DEU** Das detail muss sich frei drehen.
FRA L'élément doit tourner librement. **POL** Część powinna swobodnie obracać się. **SPA** La pieza debe girar libremente. **ITA** Il dettaglio deve ruotare liberamente.



ENG Lubricate with paraffin. **UKR** Змастити парафіном.
DEU Mit dem Paraffin schmieren. **FRA** Lubrifier à la paraffine.
POL Nasmaruj parafiną. **SPA** Lubricar con parafina. **ITA** Lubrificare con paraffina.



ENG Assembly in mirror reflection. **UKR** Збірка в дзеркальному відображенні. **DEU** Montage in spiegelreflexion.
FRA Assemblage en réflexion spéculaire. **POL** Montaż w odbiciu lustrzanym. **SPA** Montaje en reflexión especular. **ITA** Assemblaggio in riflessione speculare.



ENG Design kit can be tightly connected in some places, so that the assembled model has solidity and reliability. We recommend using pliers and box cutter for a more convenient design kit assembly. **UKR** Конструктор може в деяких місцях туго з'єднатися, для того, щоб зібрана модель мала міцність та надійність. Для більш зручної збірки конструктора, рекомендуємо використовувати плоскогубці та канцелярський ніж. **DEU** Der Konstruktor kann an einigen Stellen keine gute Verbindung herstellen, so daß das zusammengebaute Modell eine ausreichende Festigkeit und Zuverlässigkeit aufweist. Für eine bequemere Montage des Konstrukteurs empfehlen wir die Verwendung einer Zange und eines Schreibwarenmessers. **FRA** Le jeu de construction peut être étroitement connecté à certains endroits, pour que le modèle assemblé soit solide et fiable. Pour un assemblage plus pratique de jeu de construction, nous vous recommandons d'utiliser une pince et un couteau à papeterie. **ITA** Le jeu de construction peut être étroitement connecté à certains endroits, pour que le modèle assemblé soit solide et fiable. Pour un assemblage plus pratique de jeu de construction, nous vous recommandons d'utiliser une pince et un couteau à papeterie. **SPA** Le jeu de construction peut être étroitement connecté à certains endroits, pour que le modèle assemblé soit solide et fiable. Pour un assemblage plus pratique de jeu de construction, nous vous recommandons d'utiliser une pince et un couteau à papeterie. **POL** Le jeu de construction peut être étroitement connecté à certains endroits, pour que le modèle assemblé soit solide et fiable. Pour un assemblage plus pratique de jeu de construction, nous vous recommandons d'utiliser une pince et un couteau à papeterie.

ENG Warning! For the correct operation of this model, it is necessary to clean carefully and to lubricate all rubbing parts with paraffin during assembly. All mechanisms must rotate freely. **UKR** Увага! Для коректної роботи даної моделі, необхідно при збірці ретельно зачищати, змащувати парафіном усі деталі, які труться. Усі механізми повинні вільно обертатися. **FRA** Attention ! Pour le bon fonctionnement de ce modèle, il est nécessaire lors du montage de nettoyer et lubrifier soigneusement toutes les pièces à friction avec de la paraffine. Tous les mécanismes doivent tourner librement. **SPA** ¡Atención! Para el funcionamiento adecuado de este modelo a la hora de ensamblaje se recomienda alisar y lubricar cuidadosamente con parafina todos los detalles frotantes. Todos los mecanismos deben girar libremente. **ITA** Attenzione! Per il corretto funzionamento di questo modello, durante il montaggio, è necessario pulire e lubrificare accuratamente tutte le parti di sfregamento con paraffina. Tutti i meccanismi devono ruotare liberamente. **DEU** Hinweis! Für einen korrekten Betrieb dieses Modells ist bei dem Zusammenbau erforderlich, alle Reibteile sorgfältig auszuschrägen und mit Paraffin zu schmieren. Alle Bauteile sollen sich frei drehen. **POL** Uwaga! Aby ten model działał prawidłowo, podczas montażu wszystkie detale trące muszą być dokładnie oczyszczone i nasmarowane parafiną. Wszystkie mechanizmy muszą się swobodnie obracać.

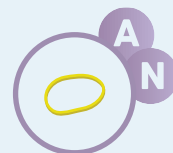

ENG Little rubber band. **UKR** Маленька резинка. **DEU** Kleines Gummiband. **FRA** Petit élastique. **POL** Mała guma. **SPA** De goma pequena. **ITA** Piccola gomma.



ENG Note! **UKR** Звернути увагу!
DEU Aufgepasst! **FRA** Faites attention!
POL Uwaga! **SPA** ¡Presta atención!
ITA Presta attenzione!

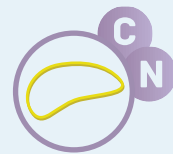

ENG Large rubber band. **UKR** Велика резинка. **DEU** Großes Gummiband. **FRA** Grand élastique. **POL** Duża gumka. **SPA** Tira de goma grande. **ITA** Gomma grande.



ENG Assembly is completed. **UKR** Збірка закінчена. **DEU** Montage abgeschlossen. **FRA** Assemblée terminée. **POL** Montaż zakończony. **SPA** Ensamblaje completada. **ITA** L'assemblaggio è finito.

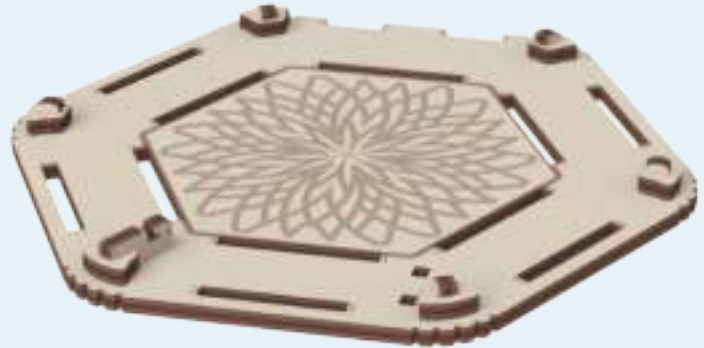
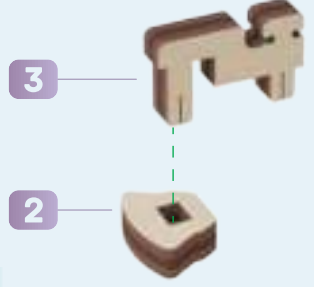
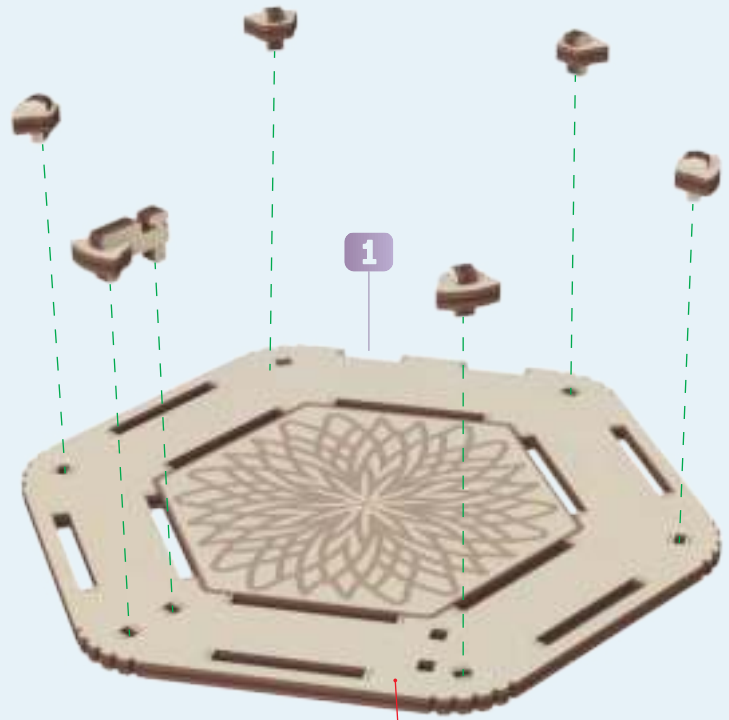
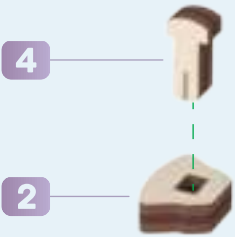

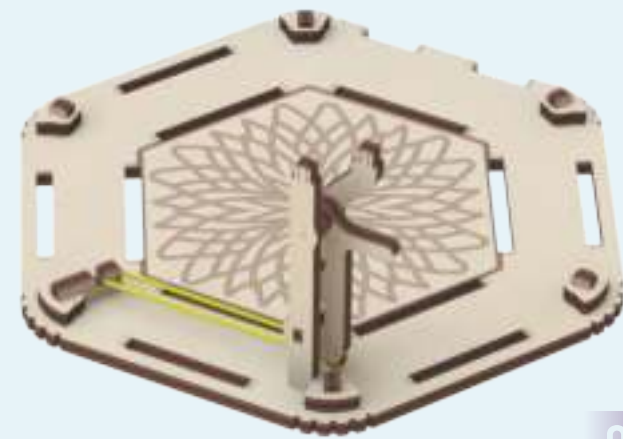
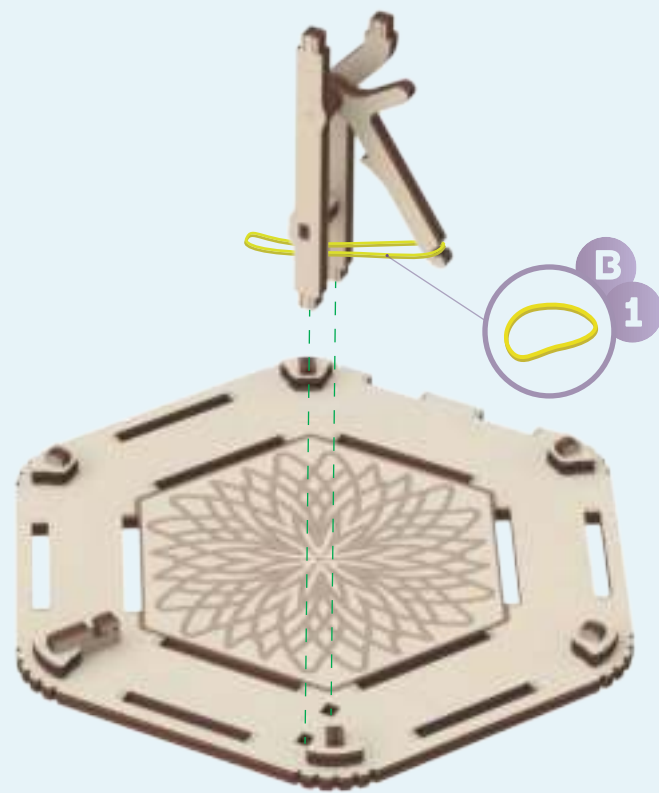
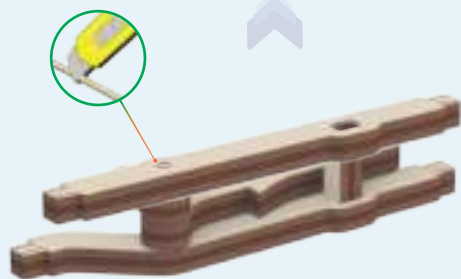
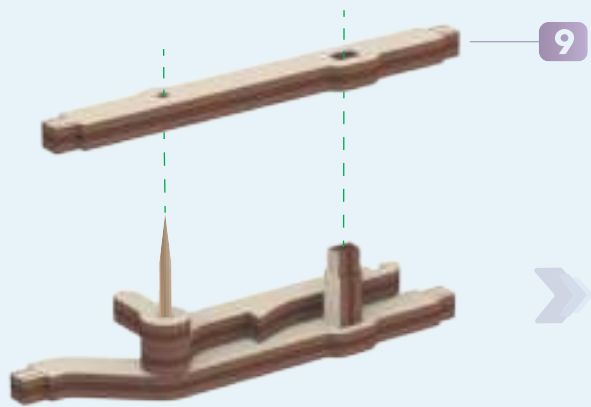
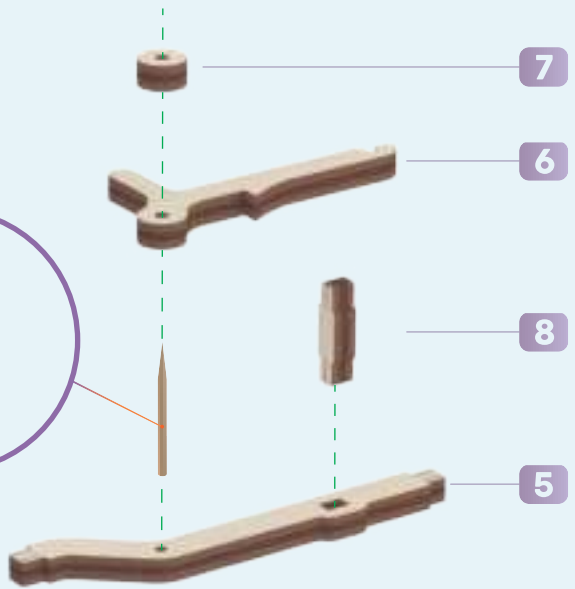
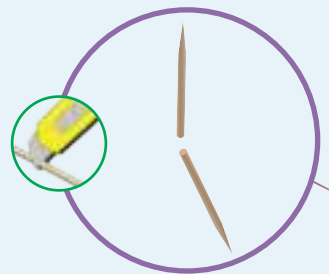

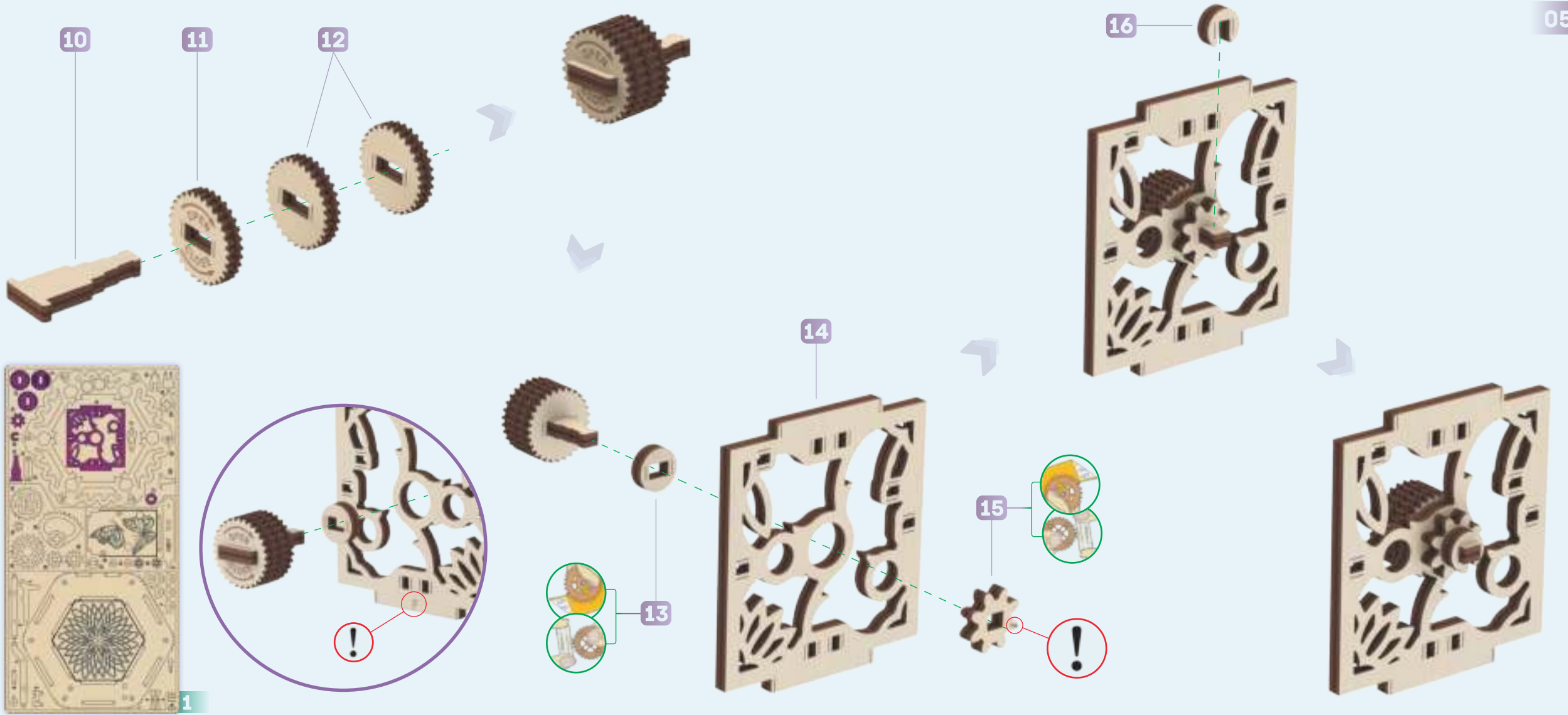

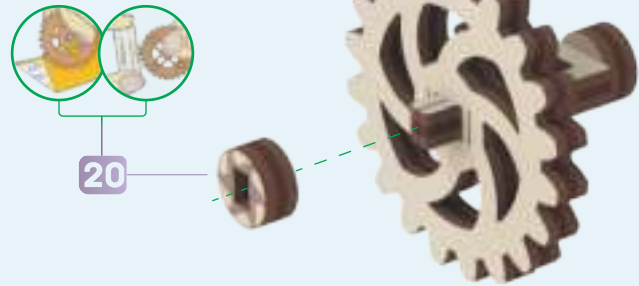
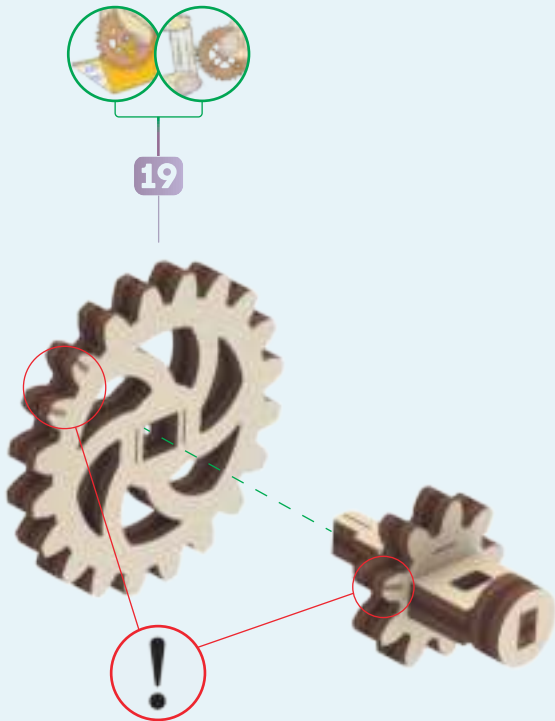
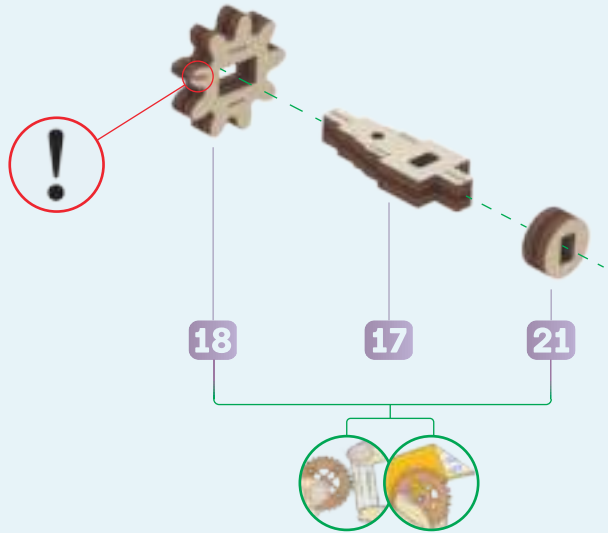

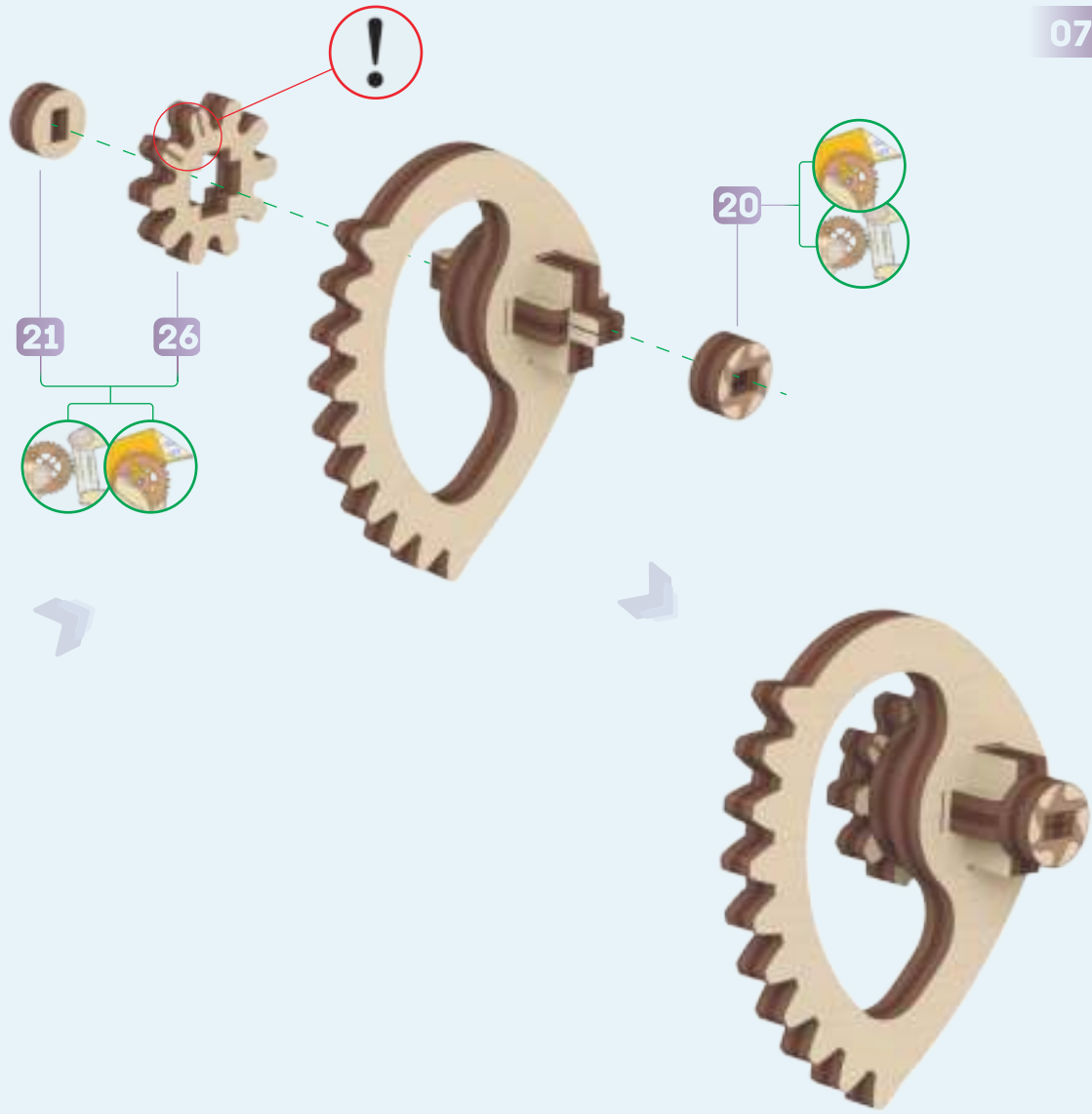
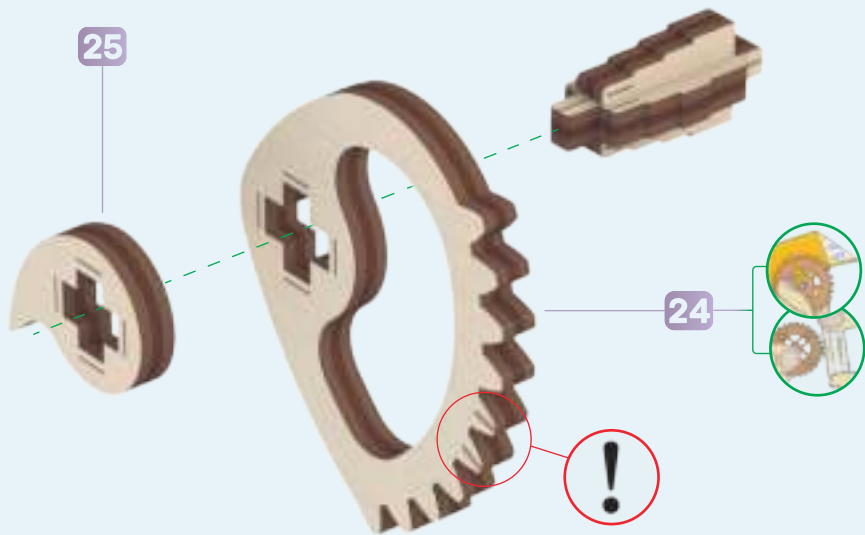
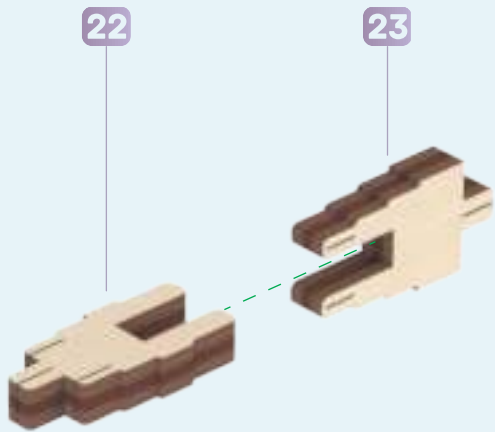

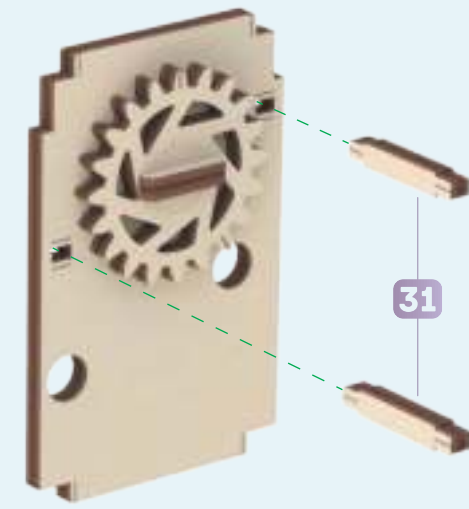
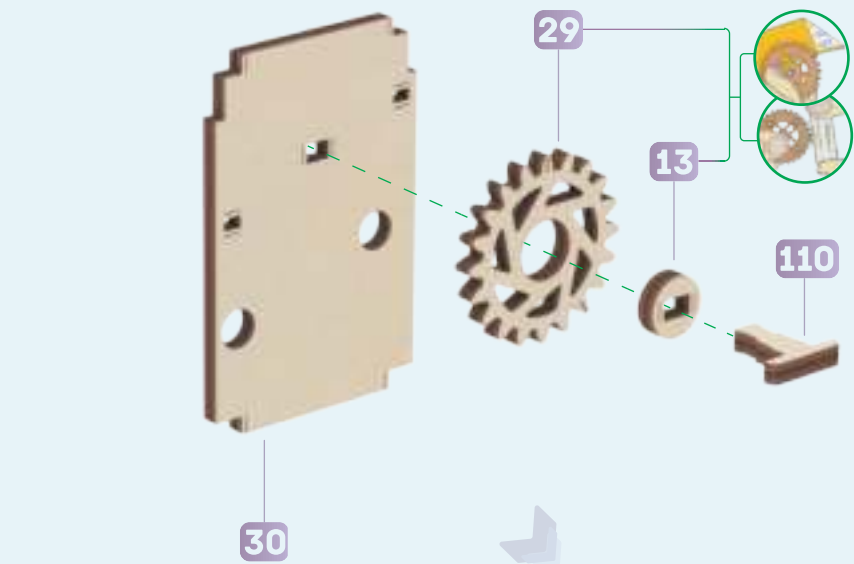

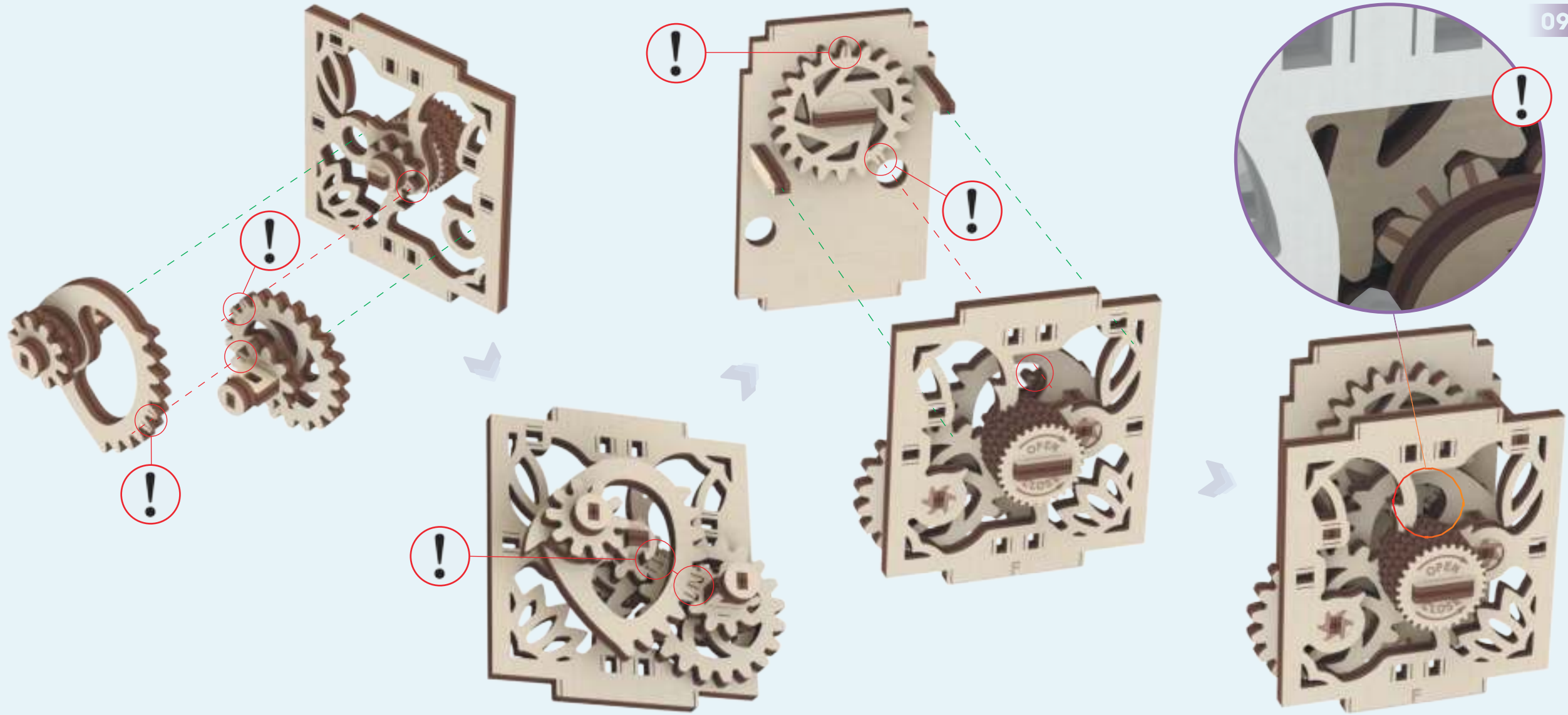

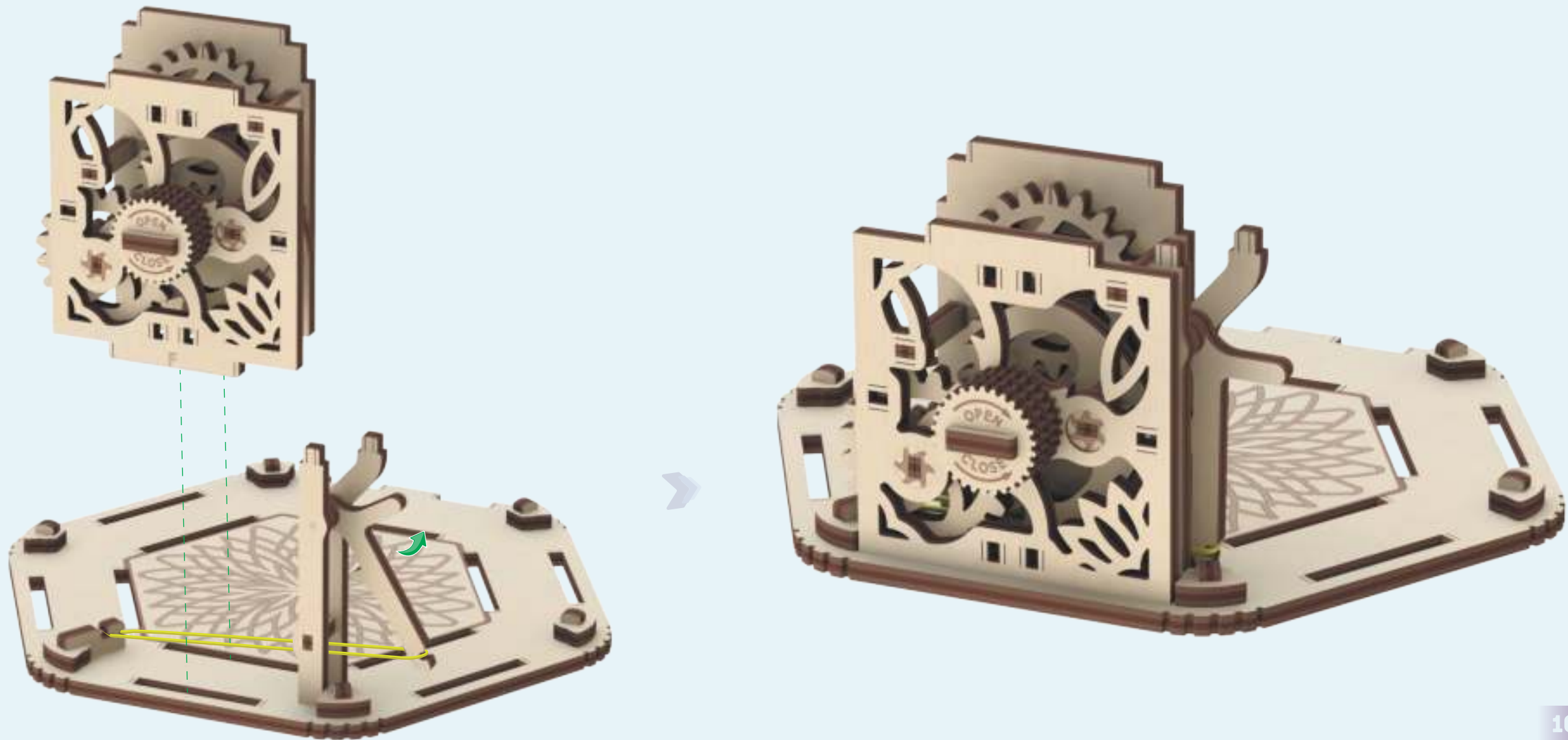

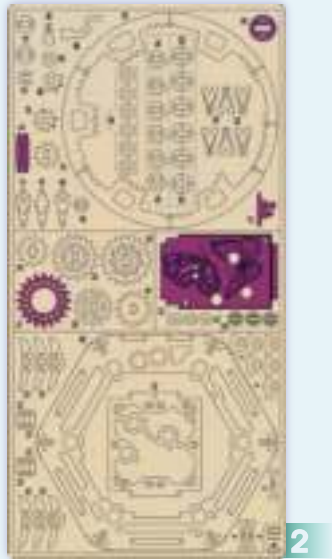

42

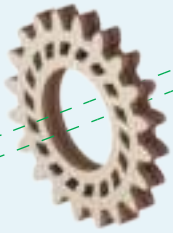

41



28



27



31





2

34



35

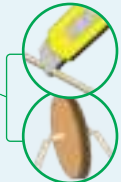

21

36

37

20

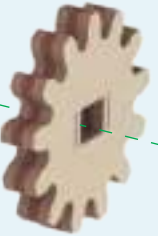

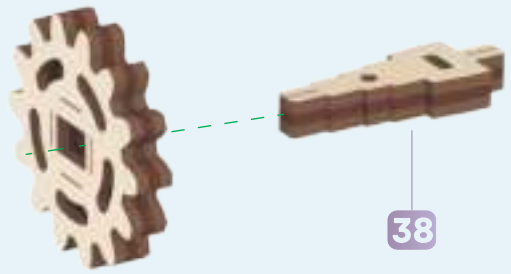

38

39

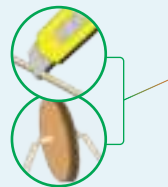

21

40



20





17

32



21



33

20

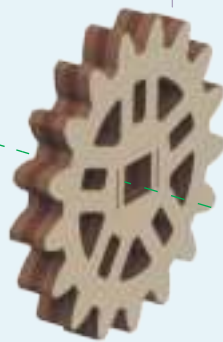



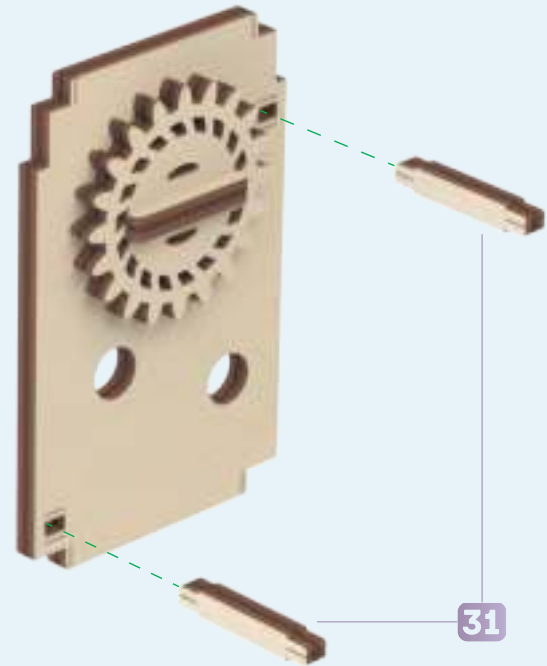
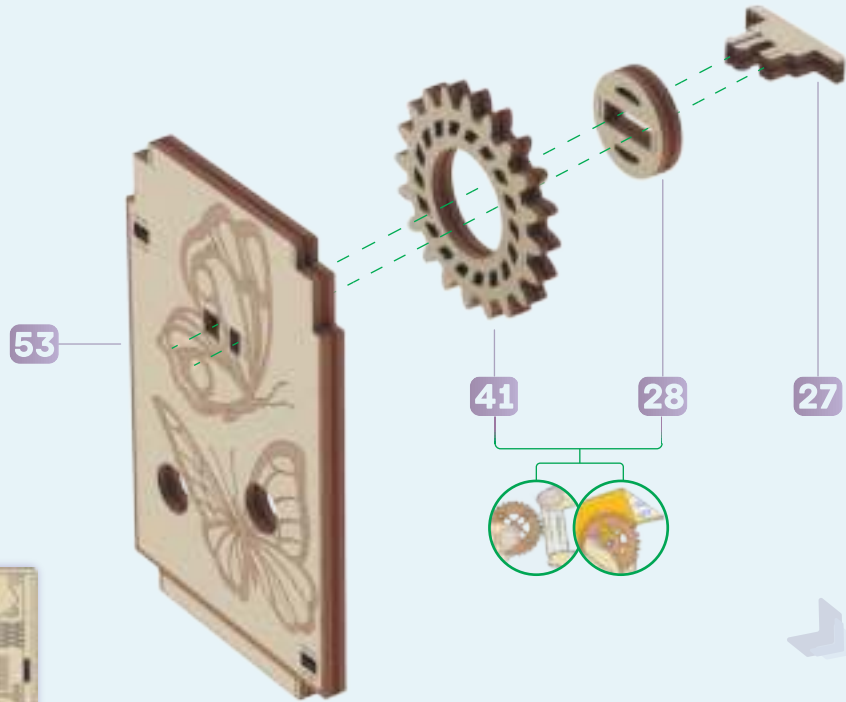

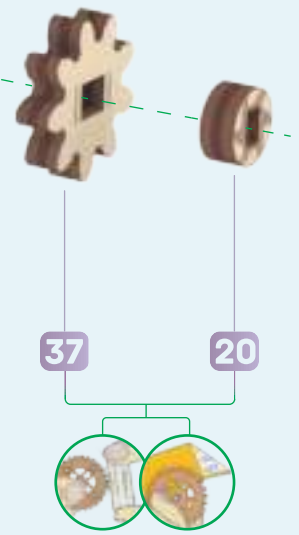
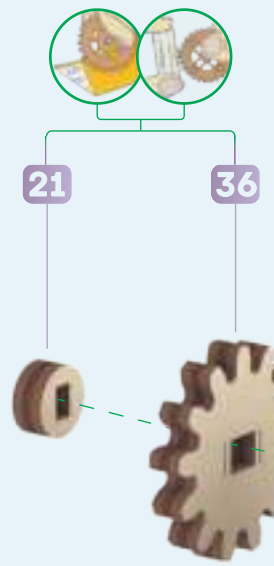
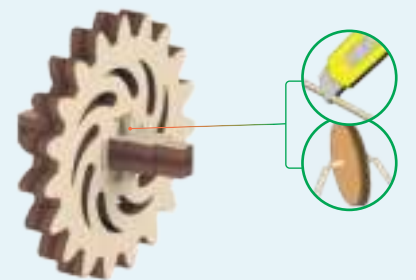

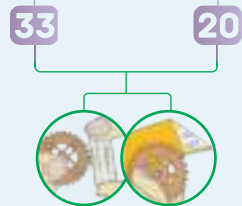
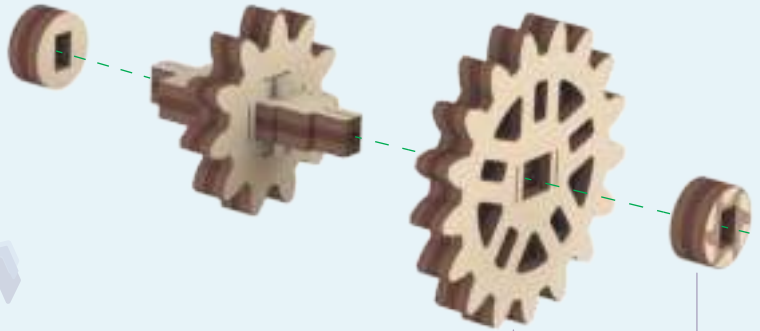
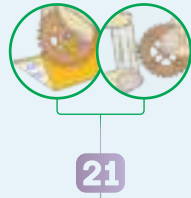
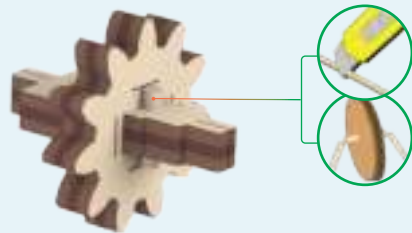
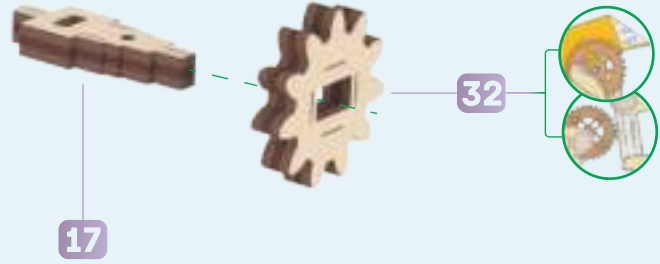

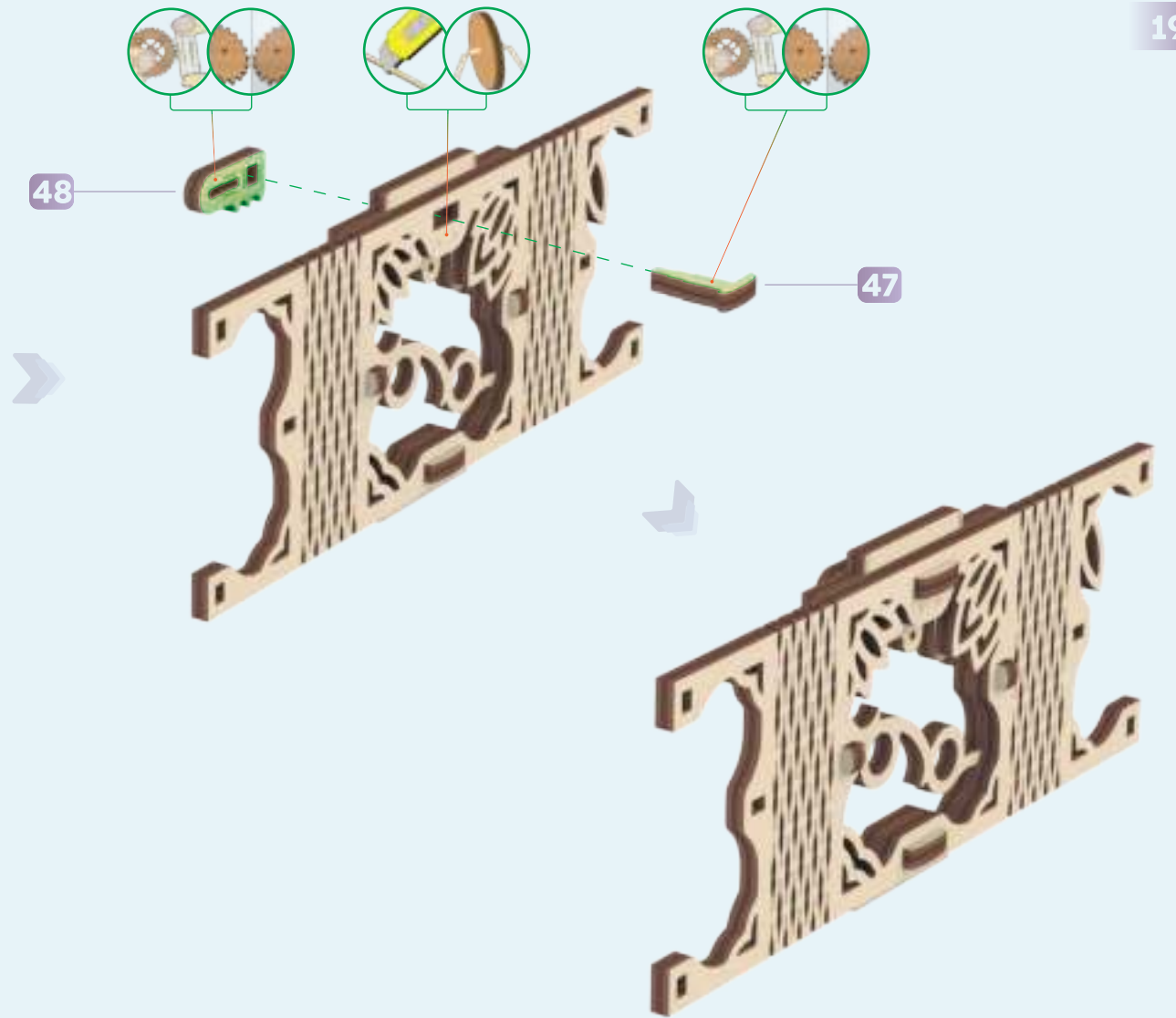
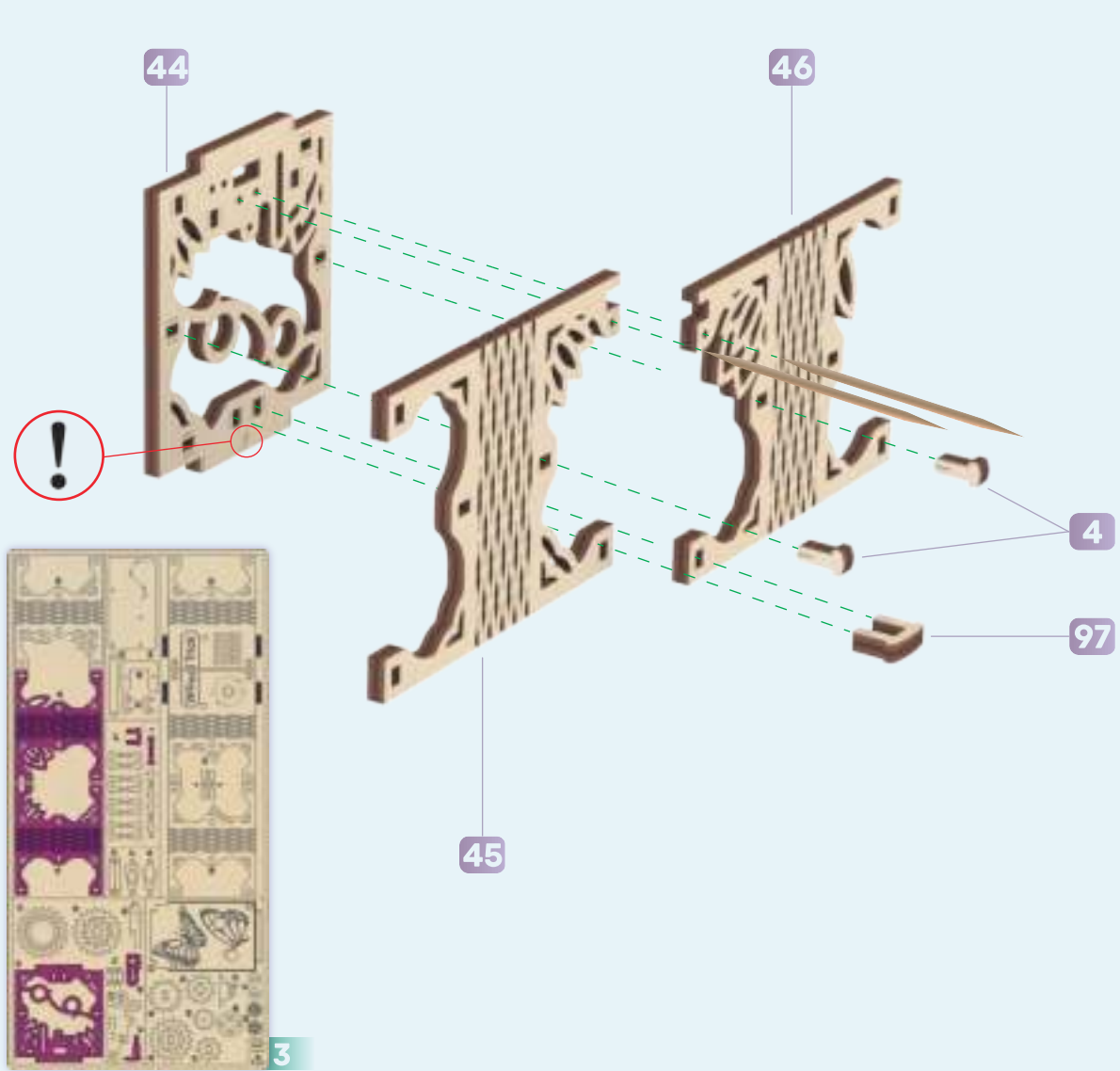



3

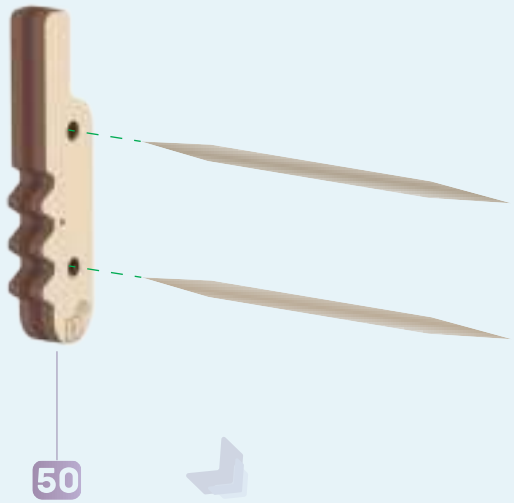

50

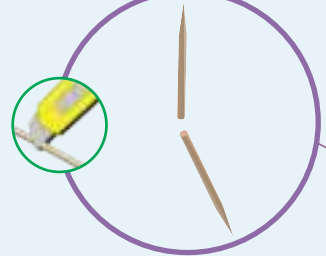
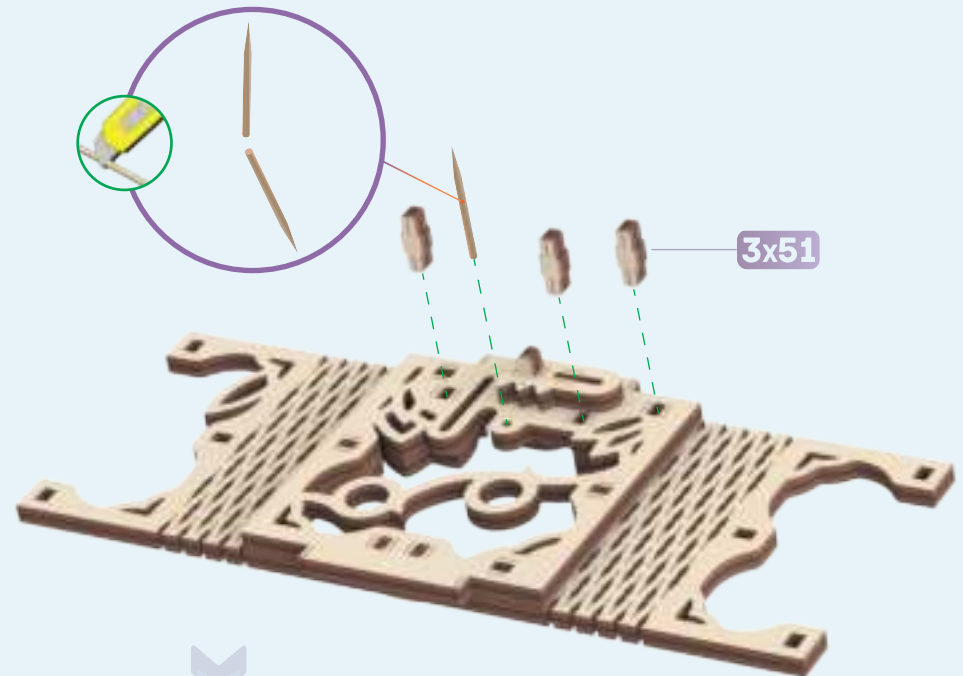
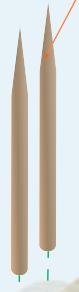
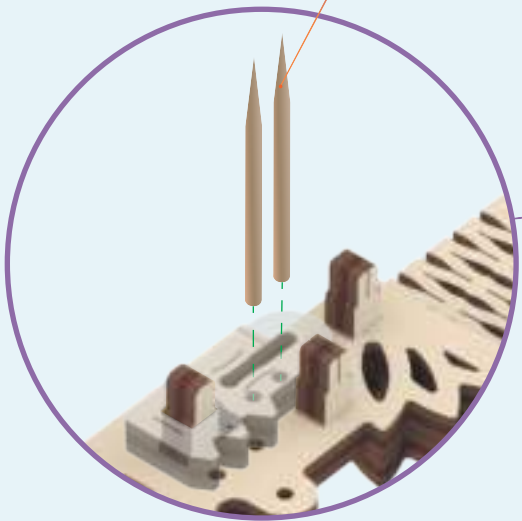
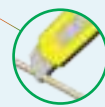
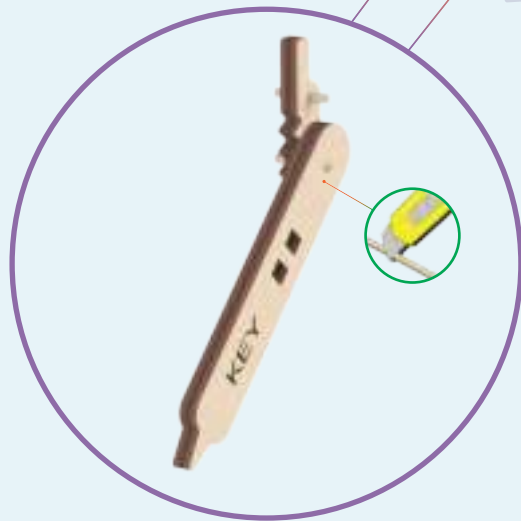
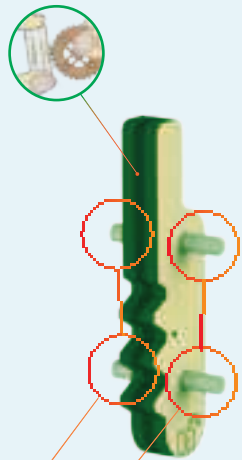

3x51

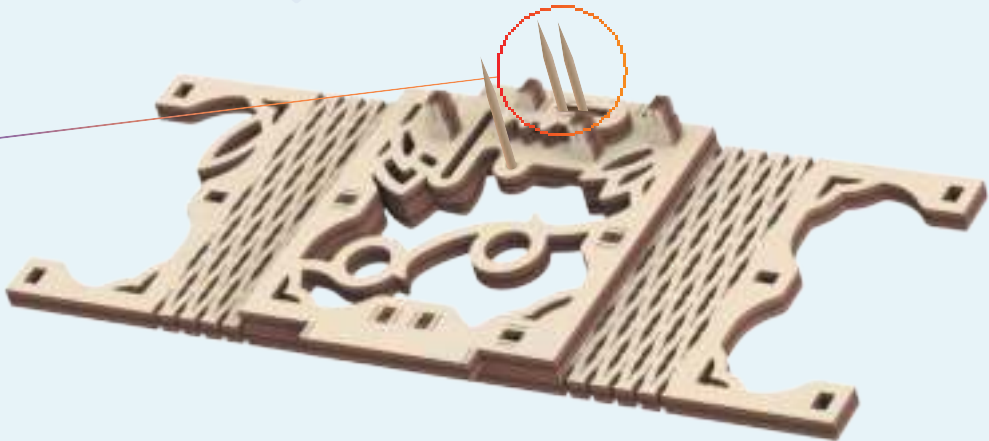

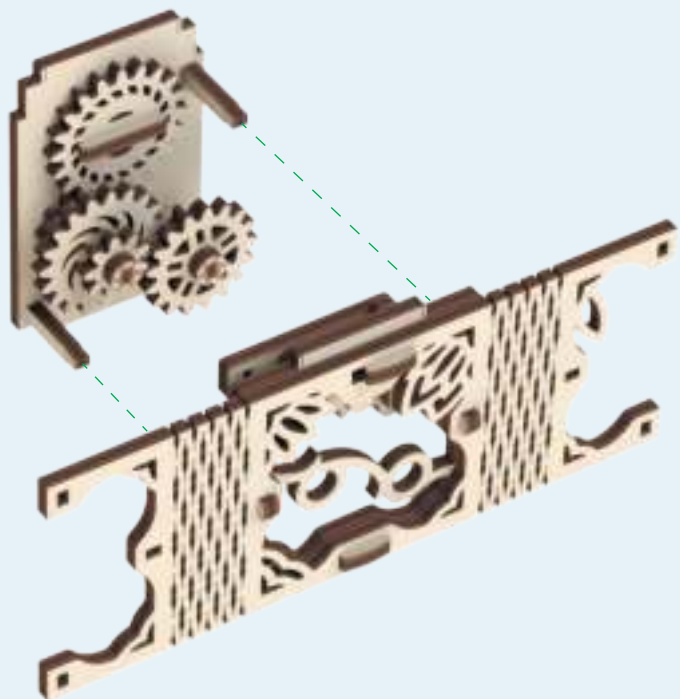

EN After being assembled, the mechanism should be activated.
This element of the unit must be switched freely without jamming.

UA Після складання, механізм потрібно розробити.
Даний елемент вузла повинен вільно перемикатися без заїдань.

DE Nach der Montage sollte der Mechanismus ausgearbeitet werden.
Dieses Bauteil-Element muss frei schalten, ohne festzuklemmen.

FR Après l'assemblage, le mécanisme doit être travaillé.
Cet élément de la partie constructive doit commuter librement sans coincements.

ITL Dopo l'assemblaggio, il meccanismo deve essere sviluppato.
Questo elemento dell'unità deve passare liberamente senza inceppamenti.

SP Hace falta poner en operación el mecanismo después de su montaje.
El elemento dado del nudo debe conmutarse sin atrancos.

PL Po montażu mechanizm należy rozpracować.
Ten element supła musi się swobodnie przełączać bez zakleszczania.

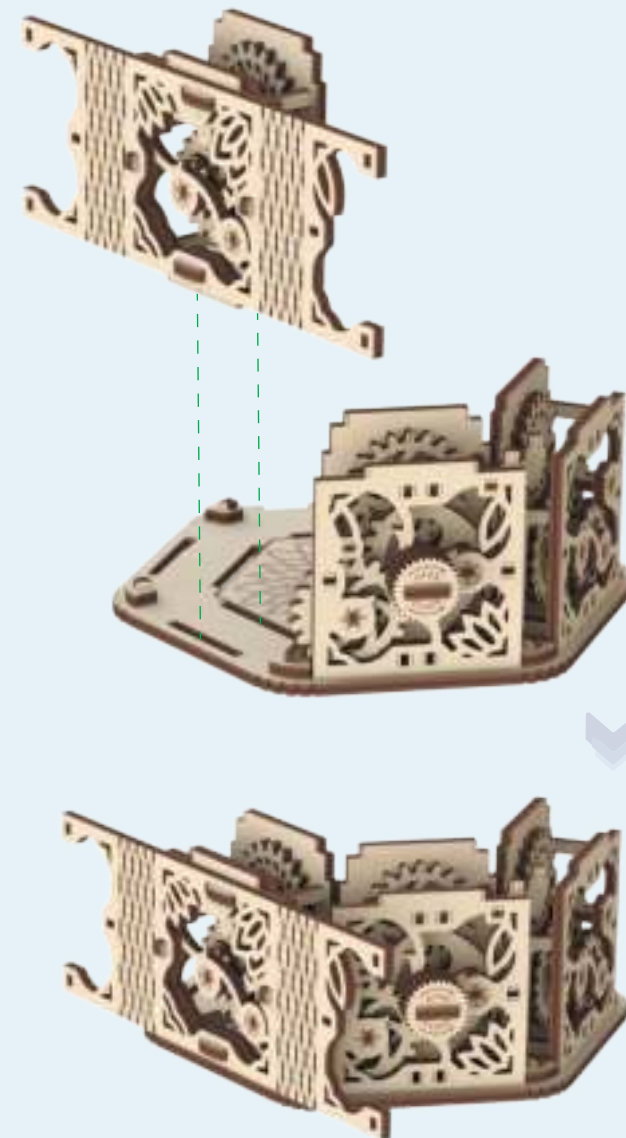
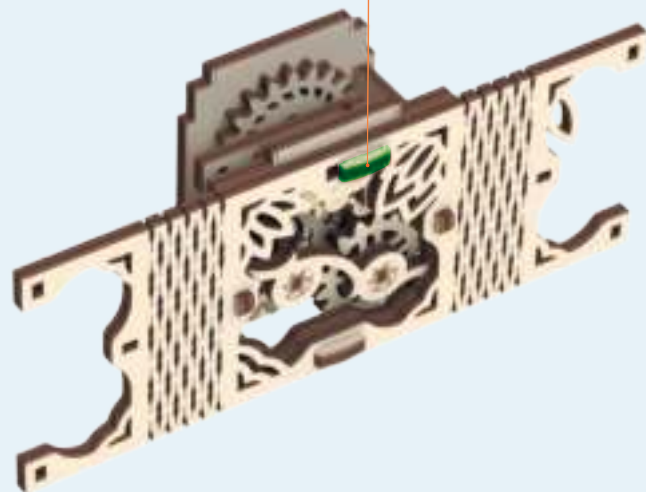



5

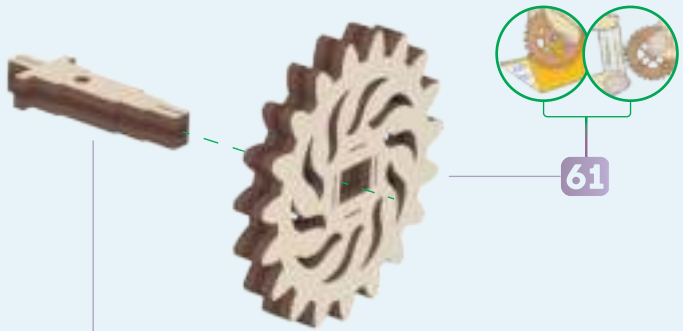

70

61

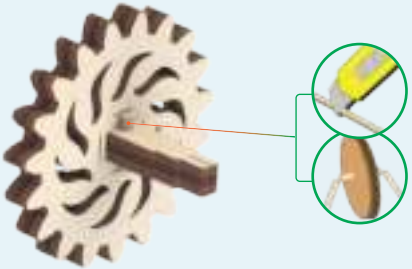

21

x2

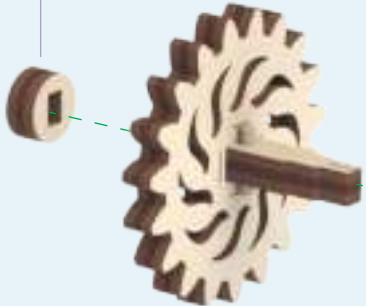

62

20



64

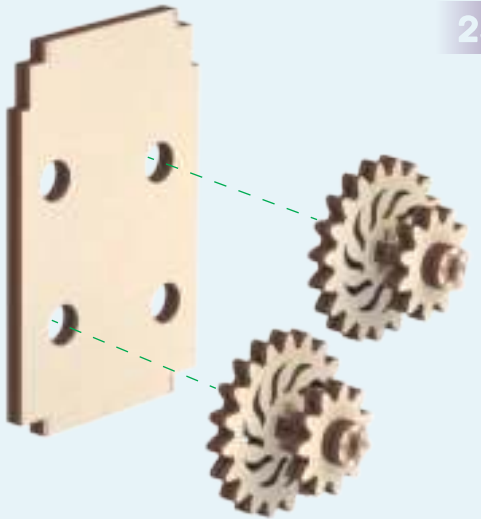

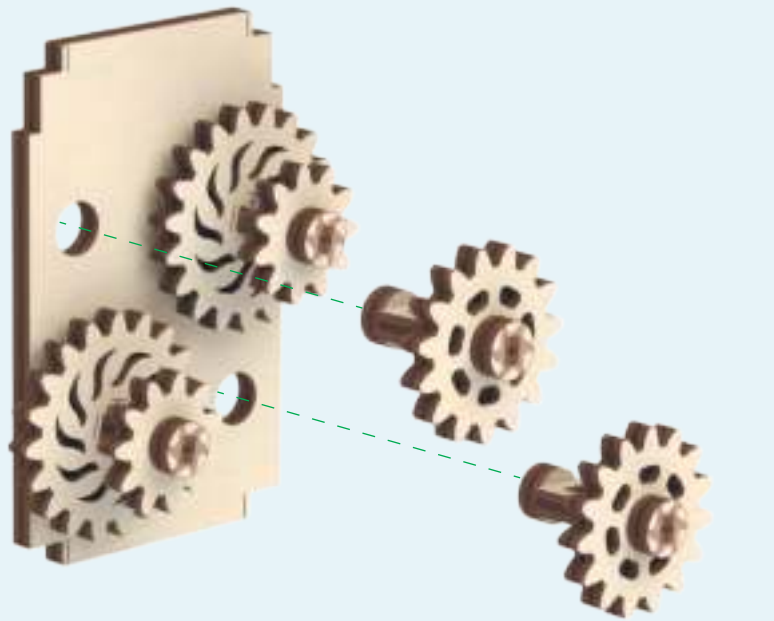
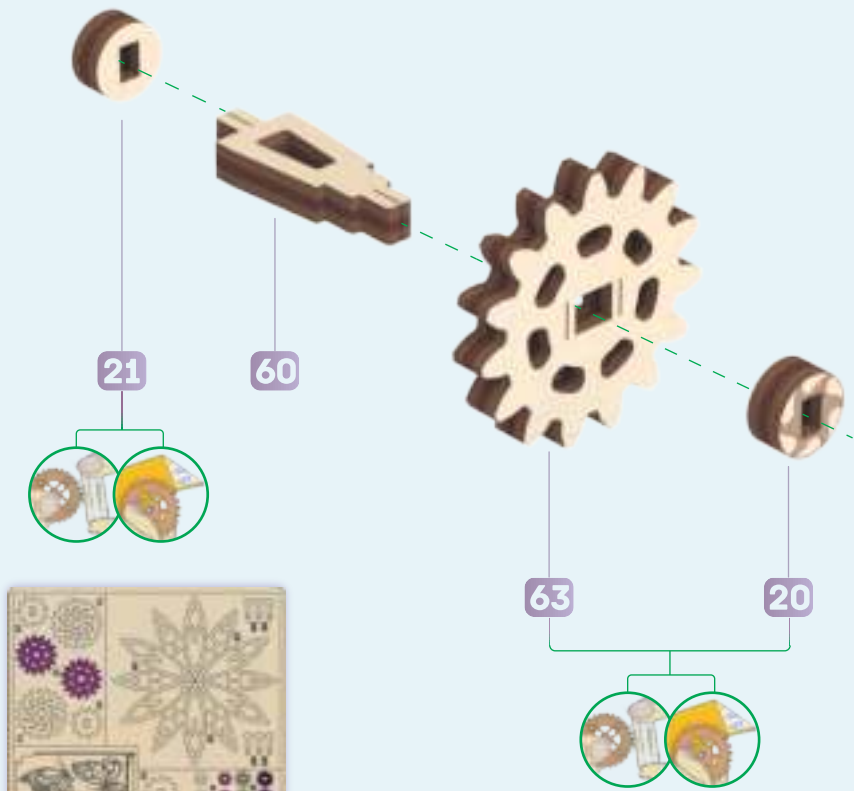

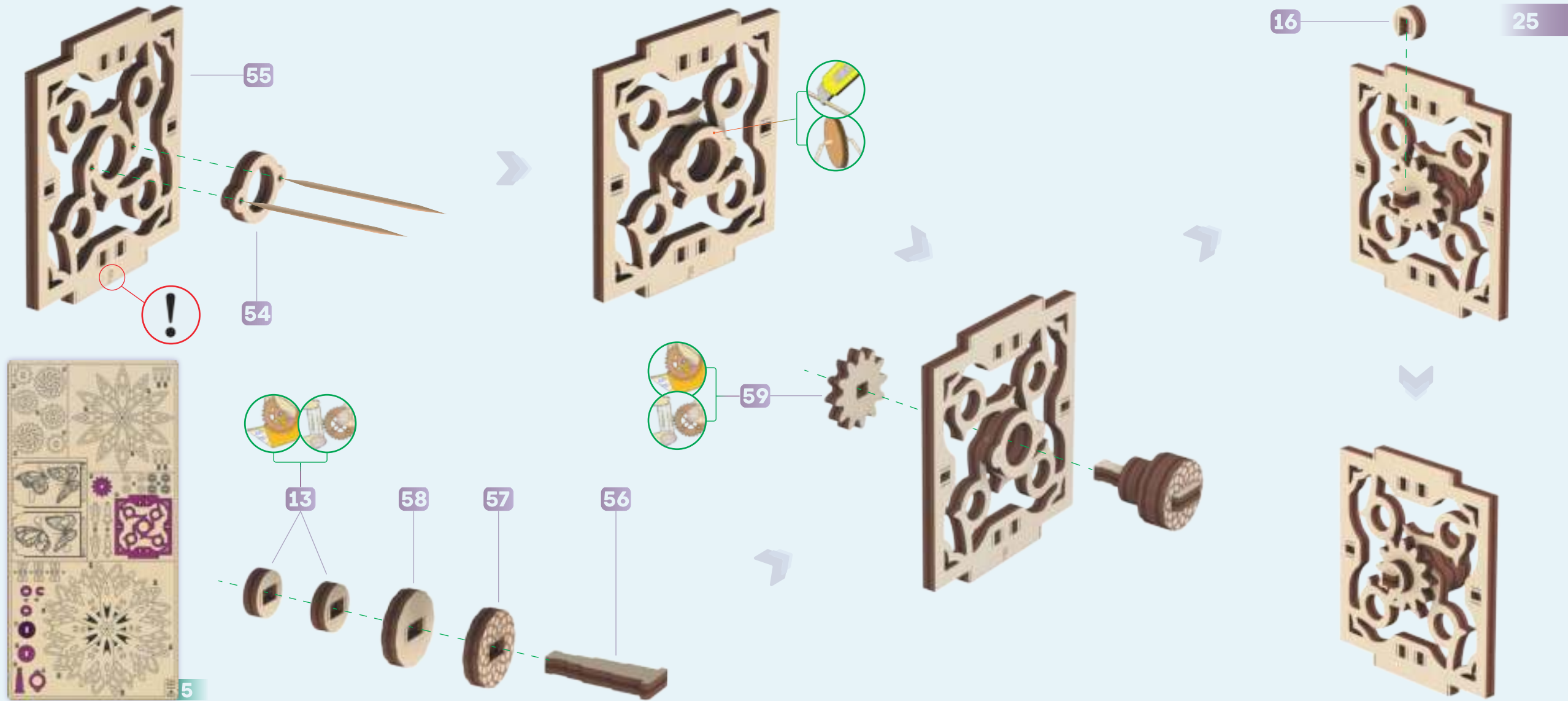

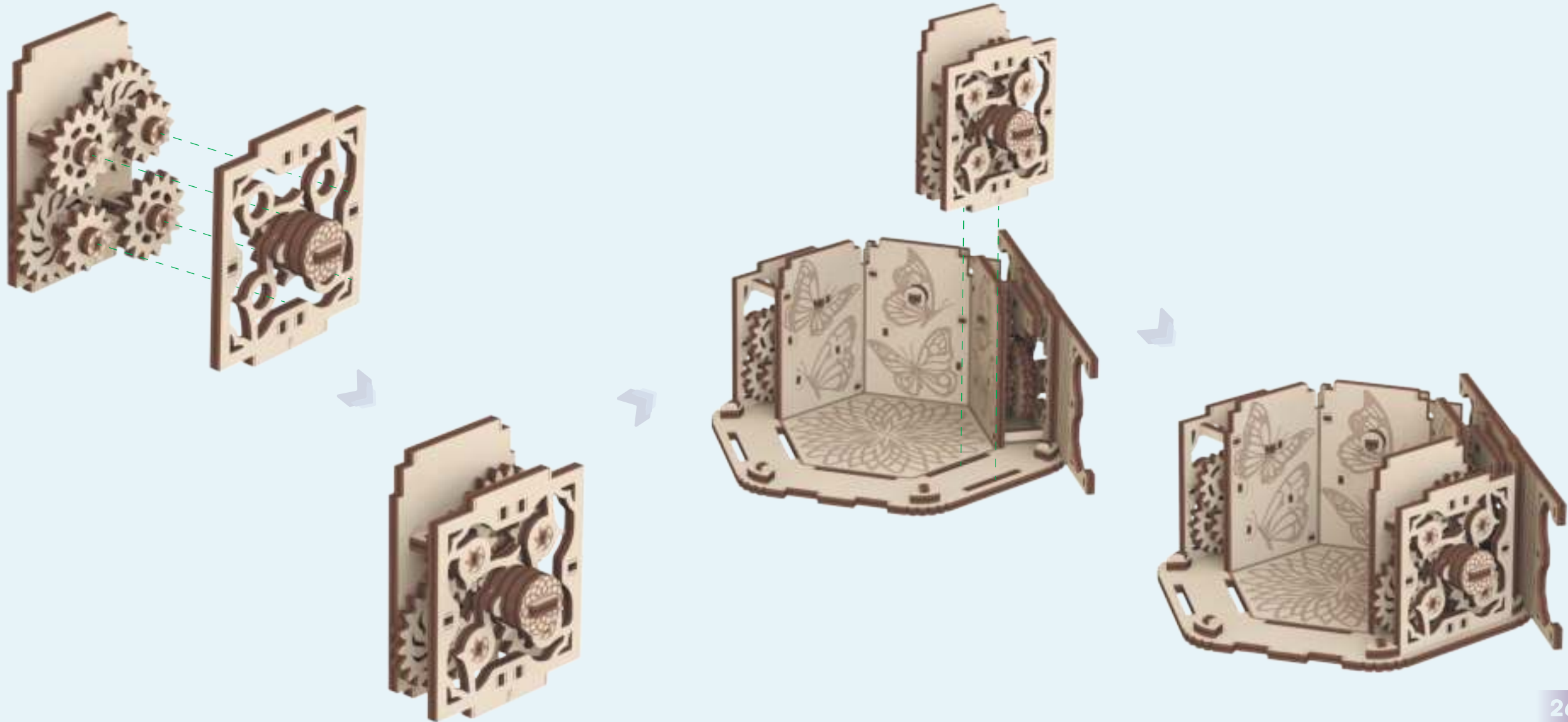

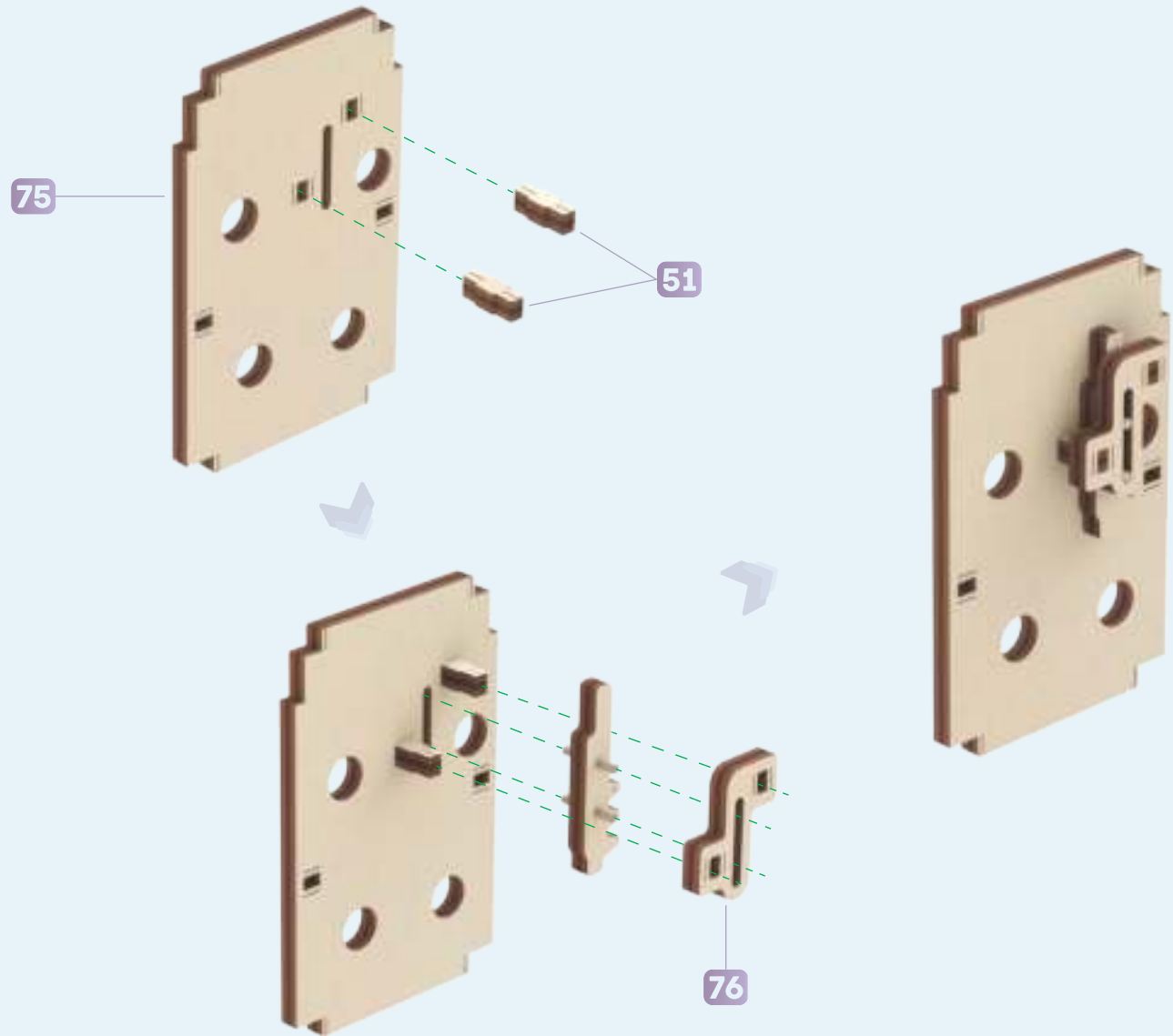
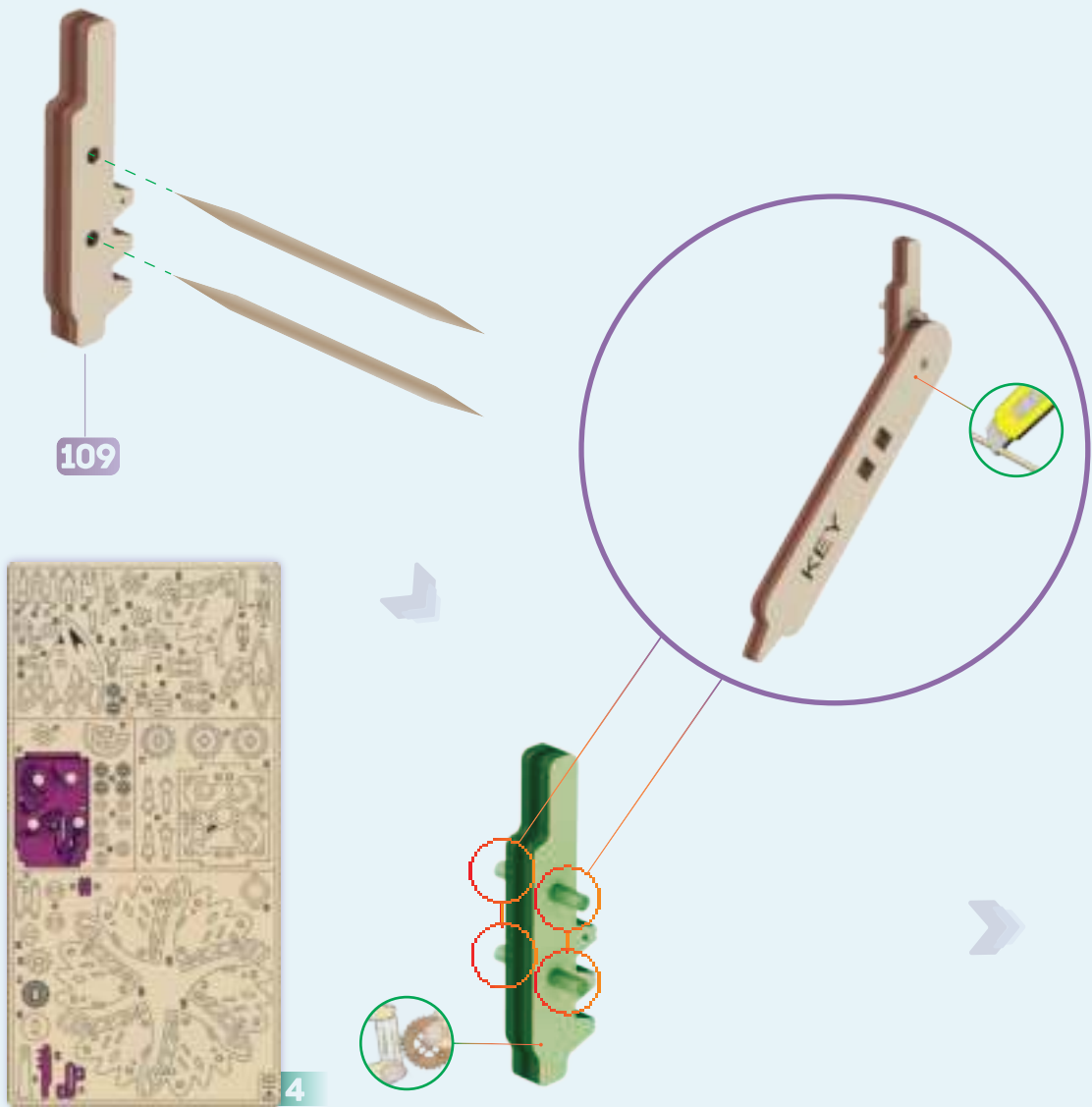

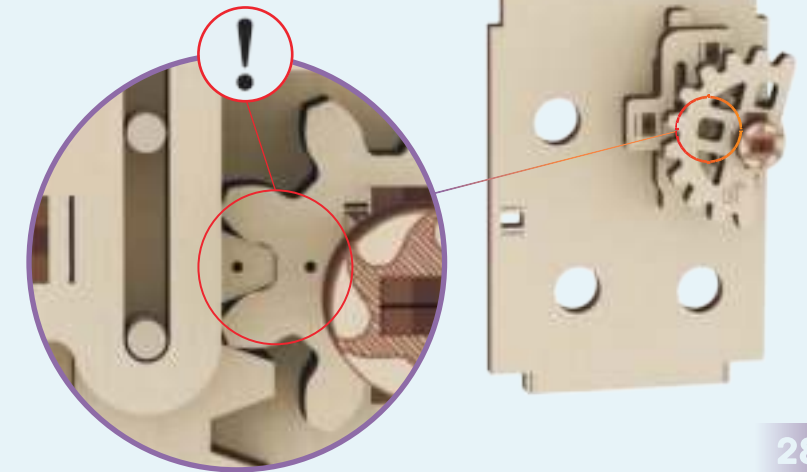
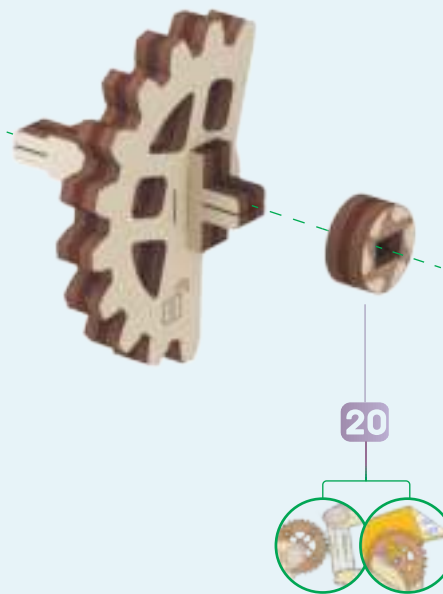
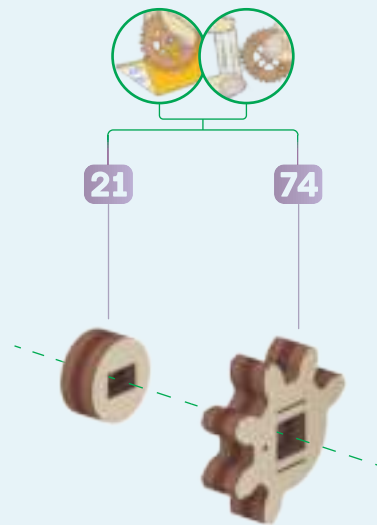
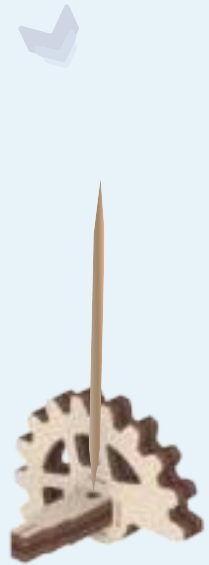
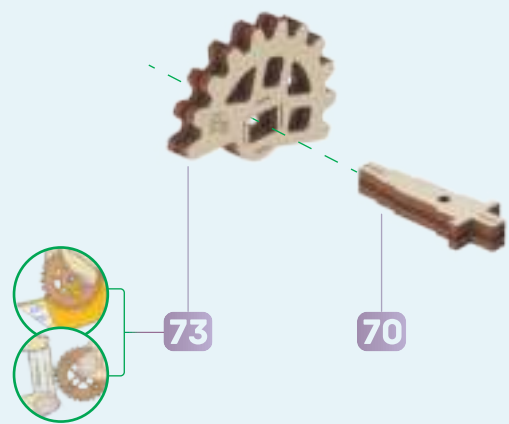
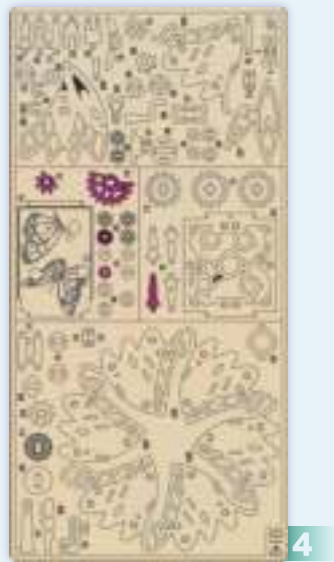

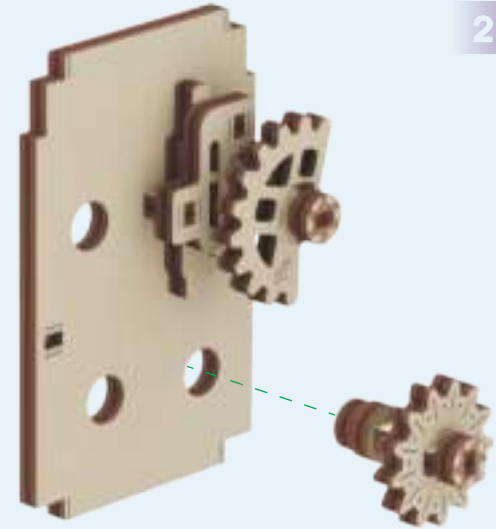
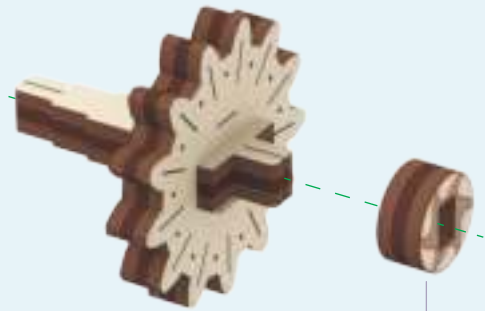
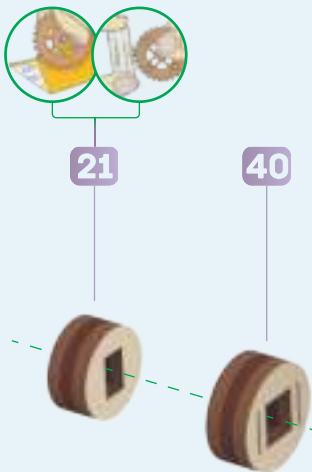
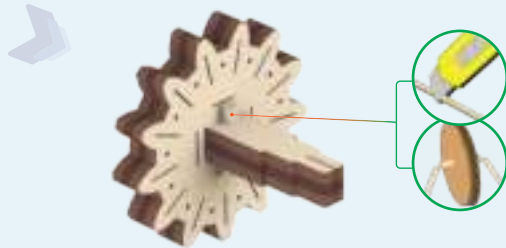
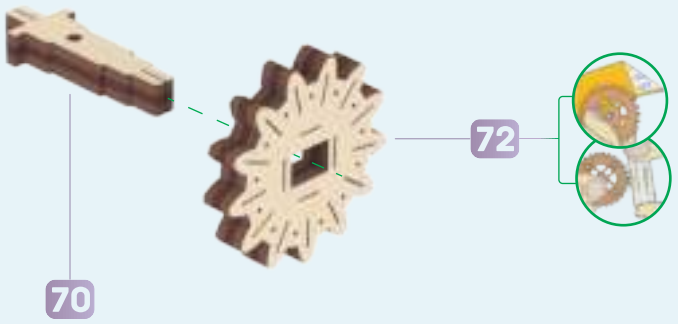
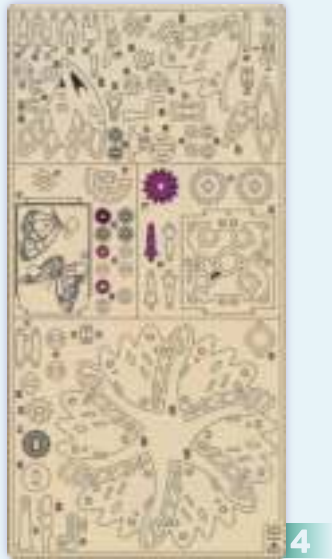

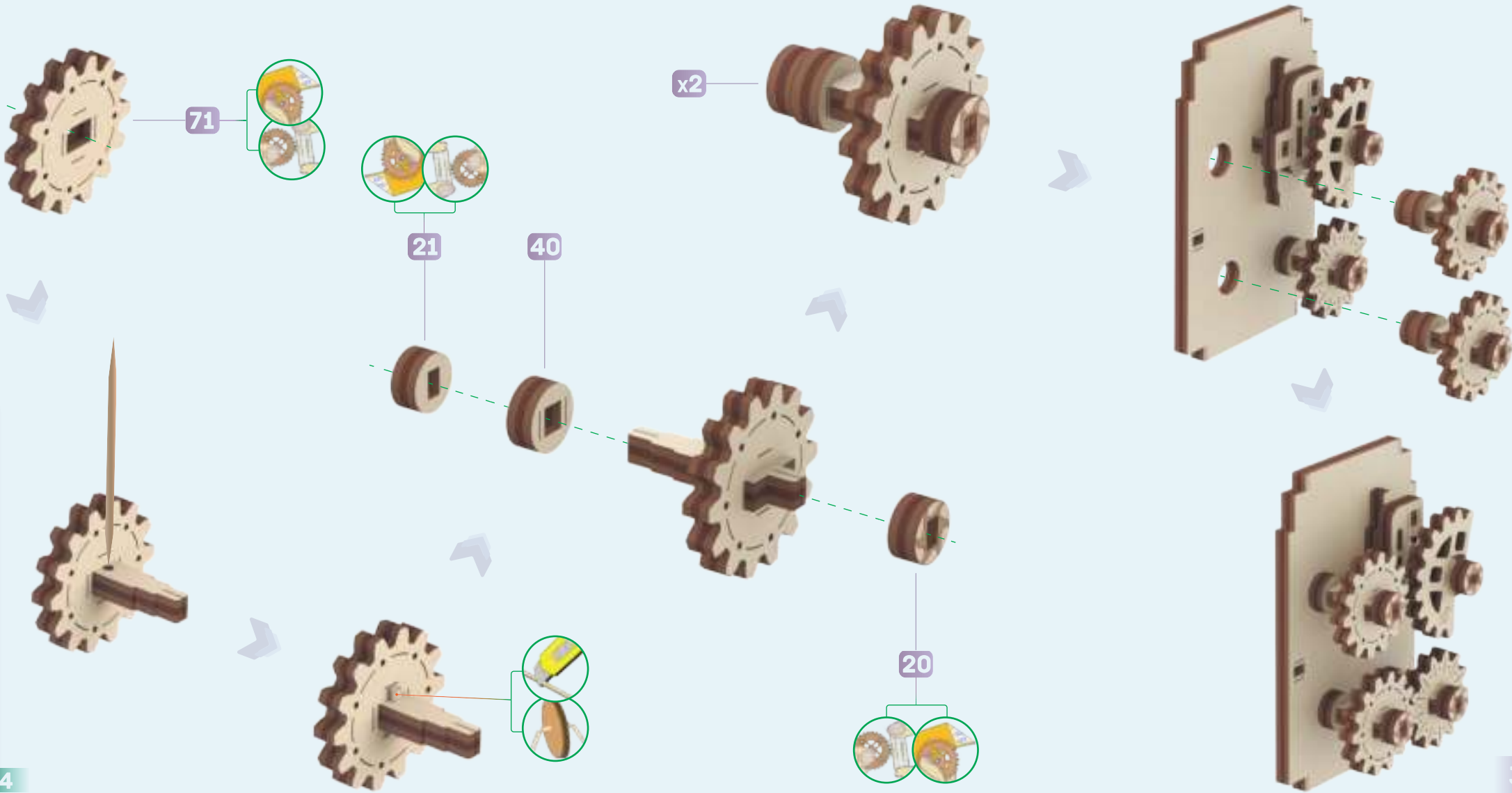

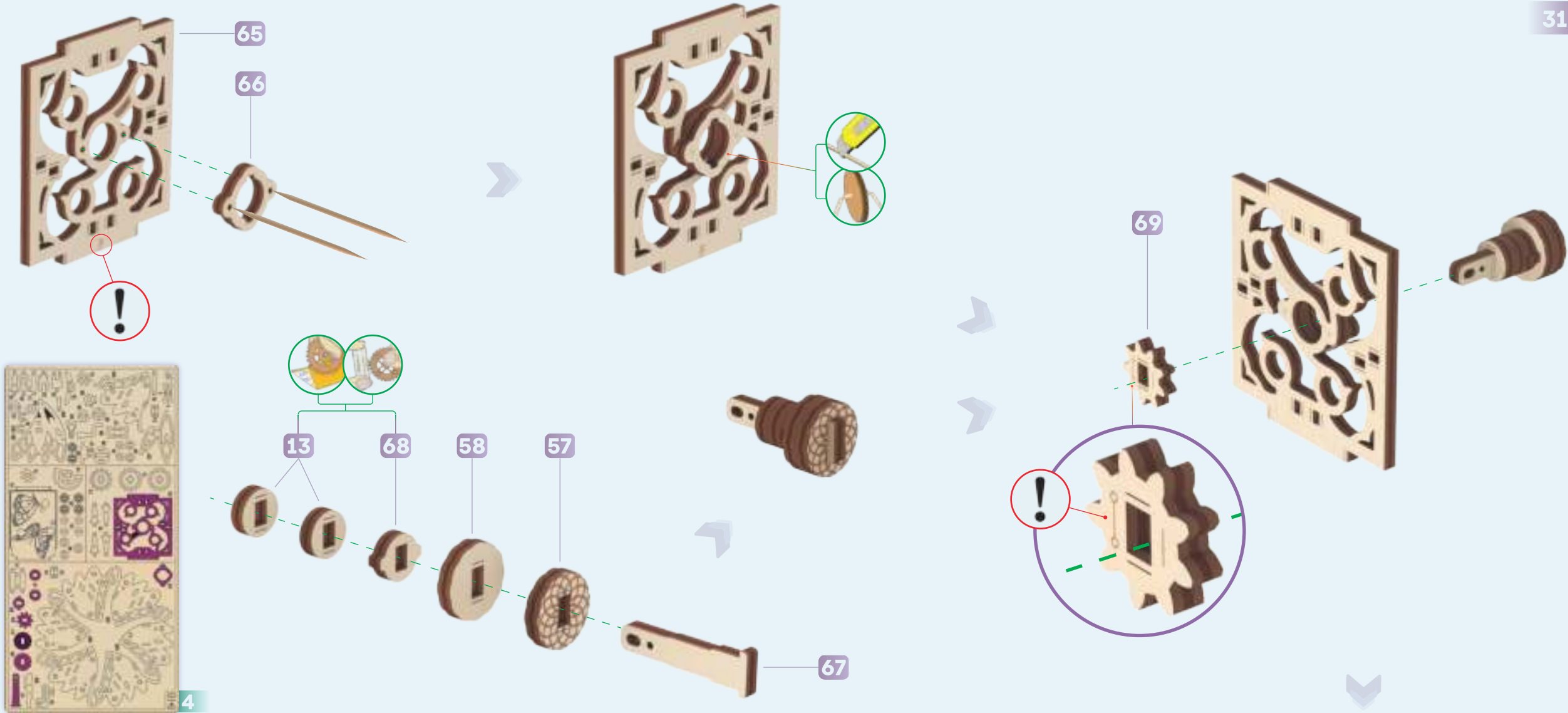

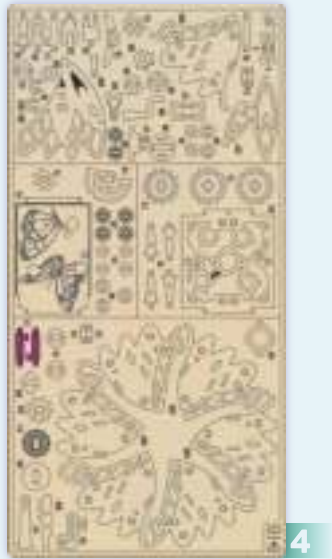

4

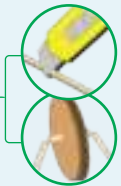
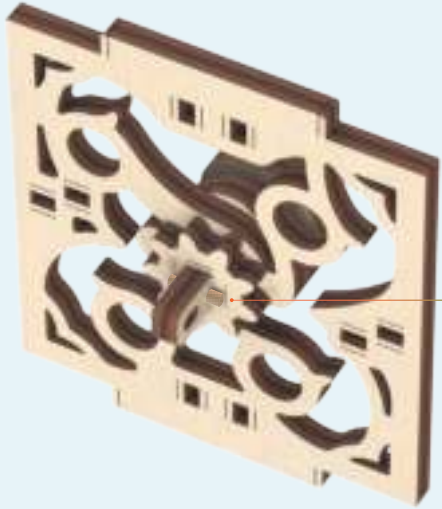
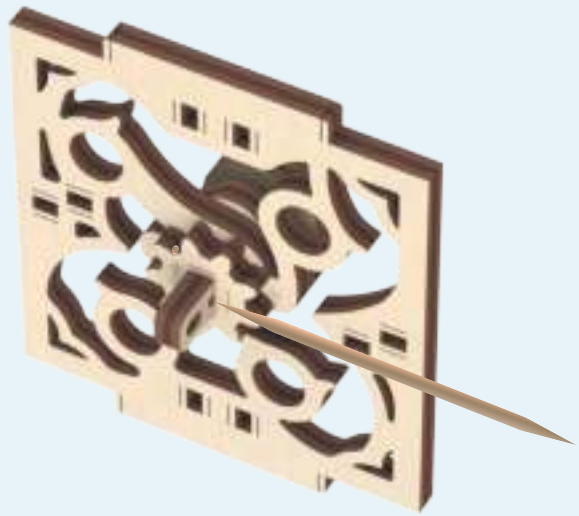

77

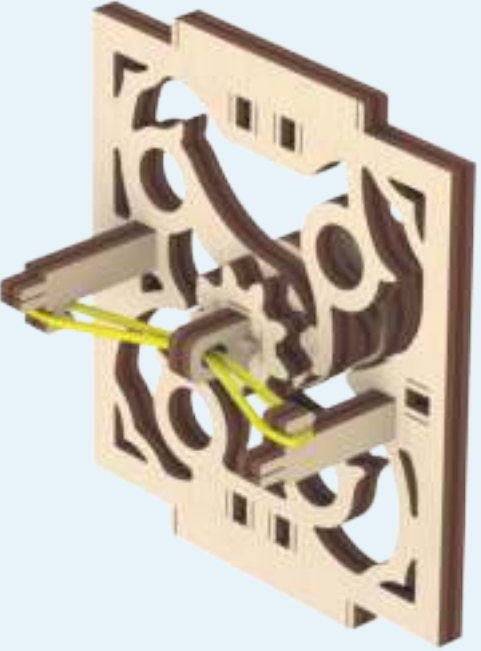
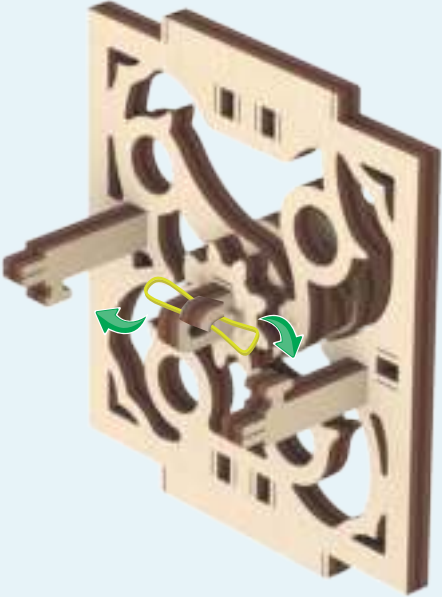
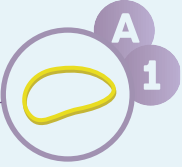
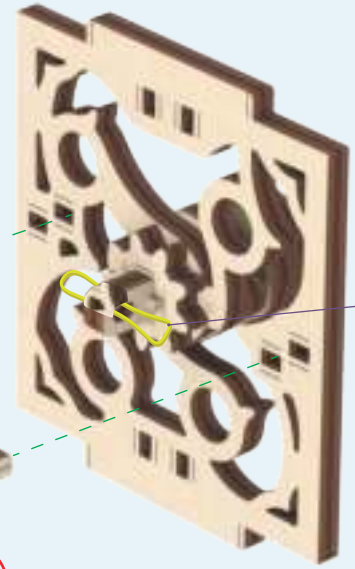



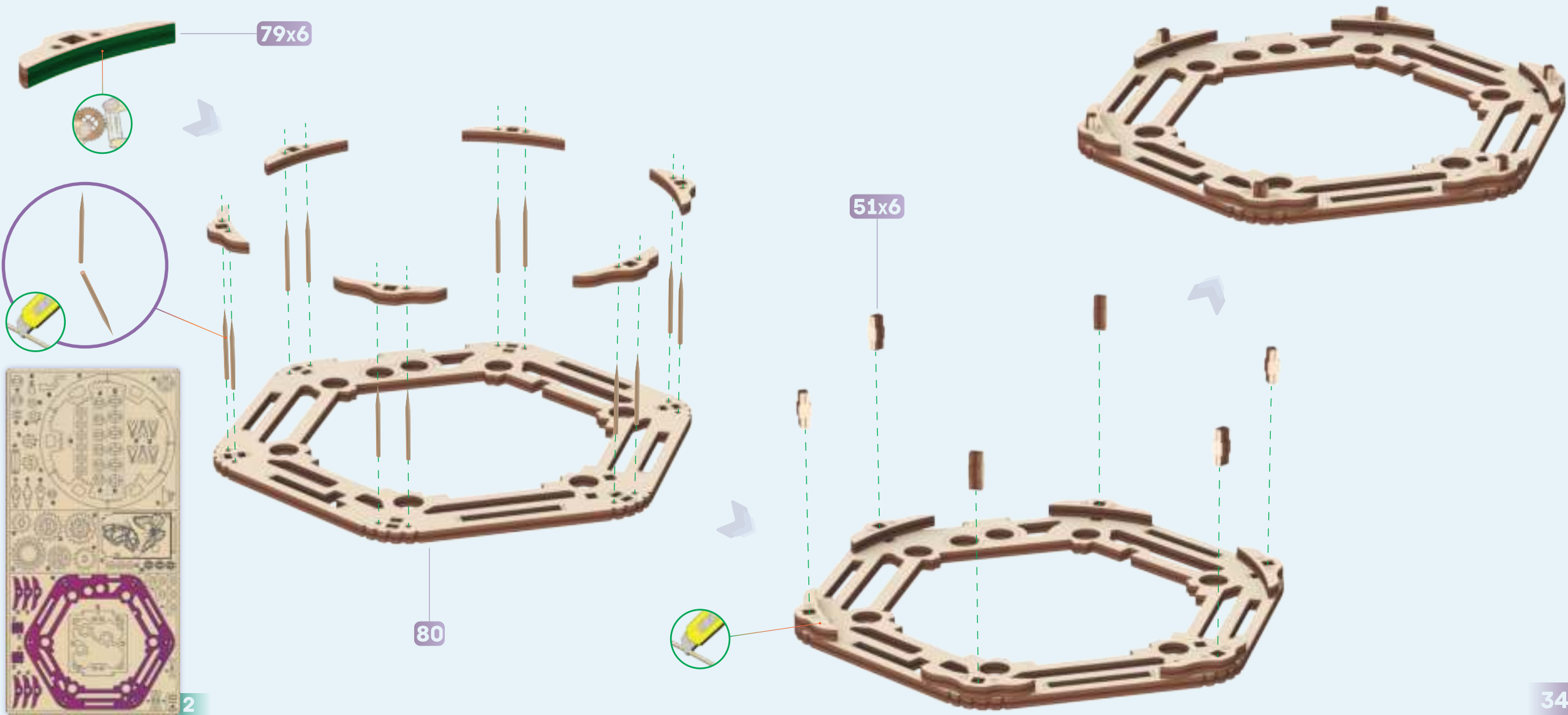



2



4



x6

2

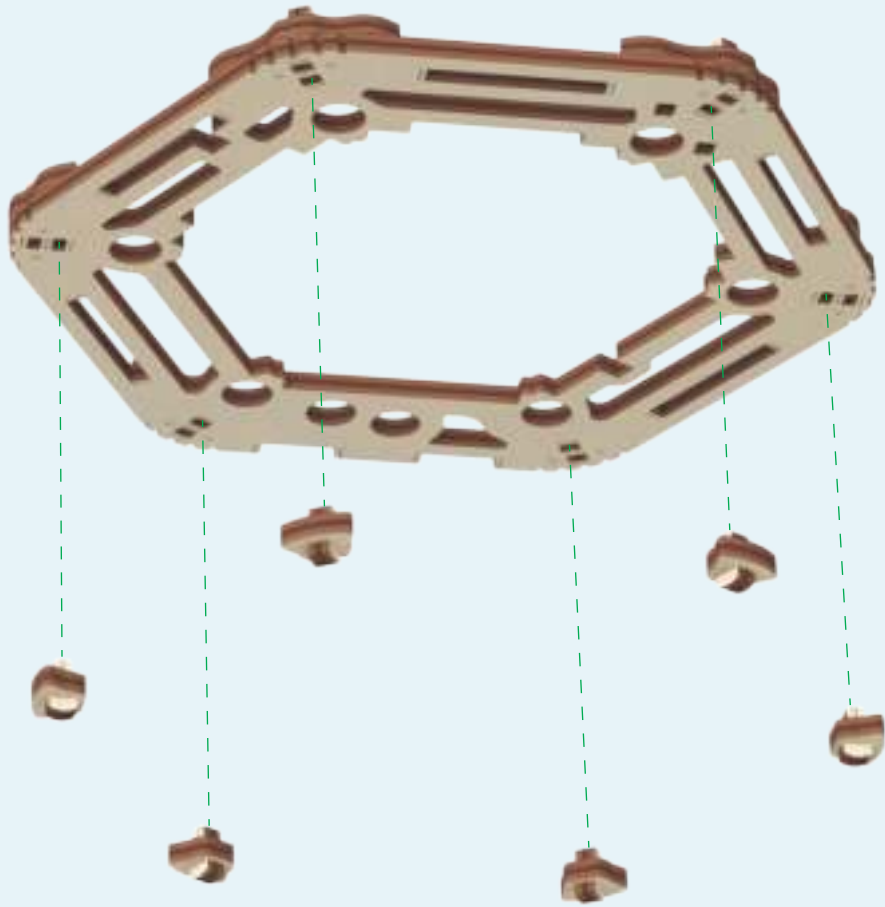

78

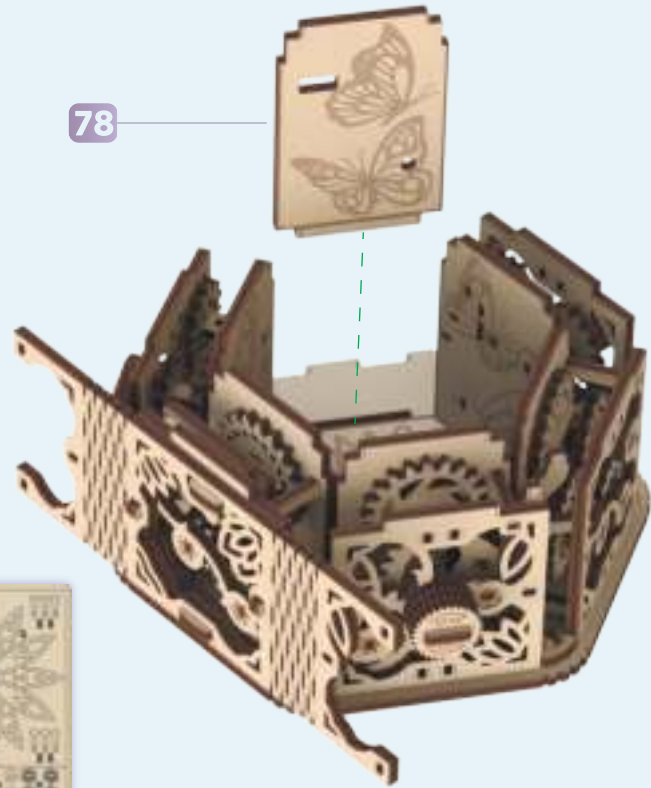

5

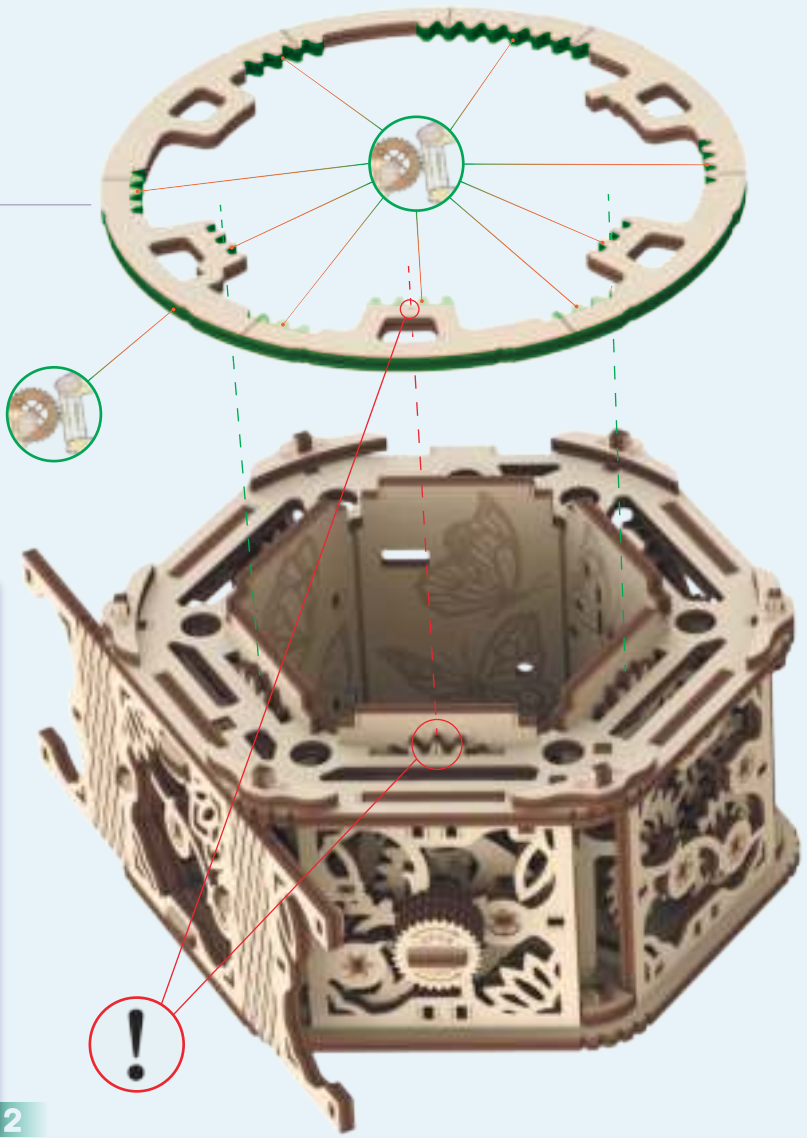
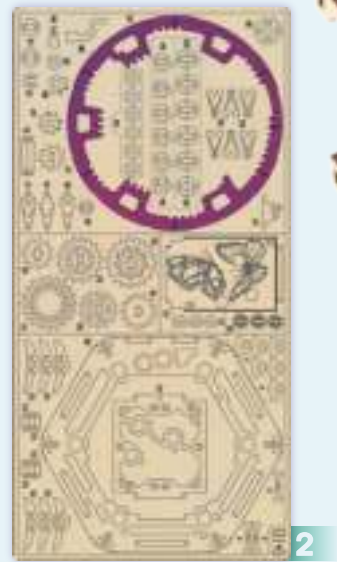

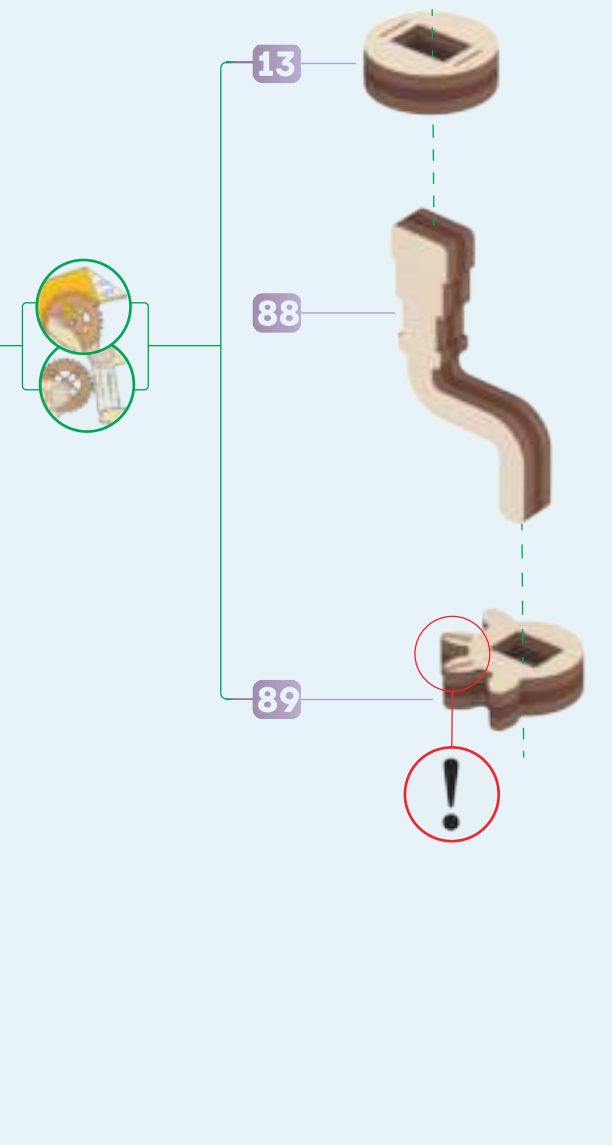
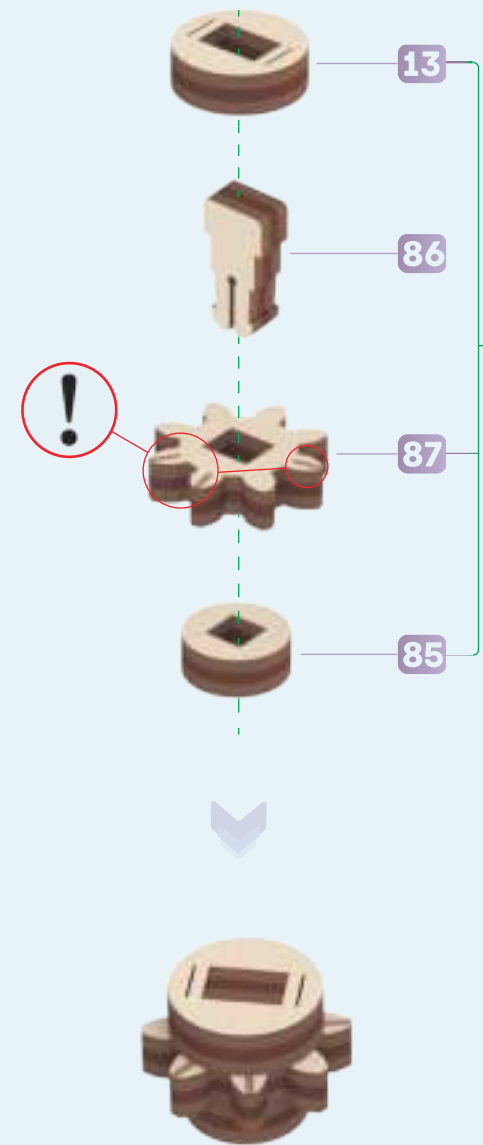
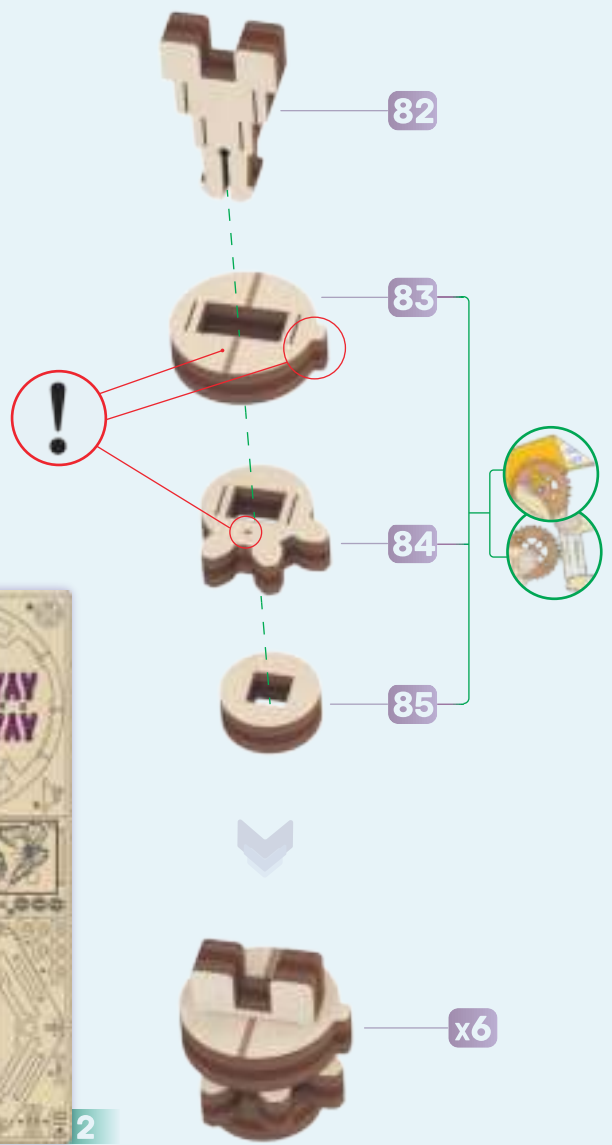
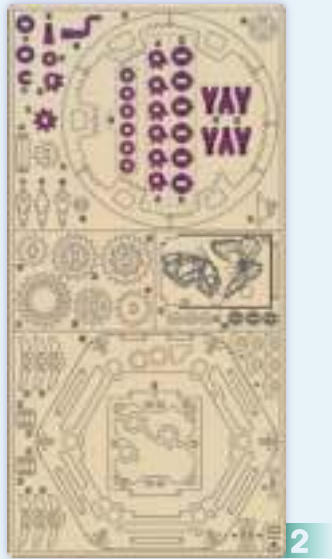

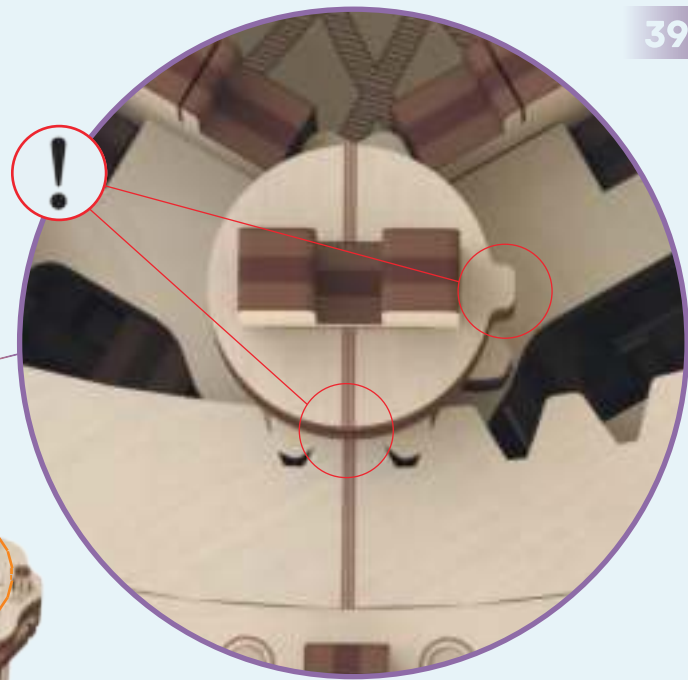
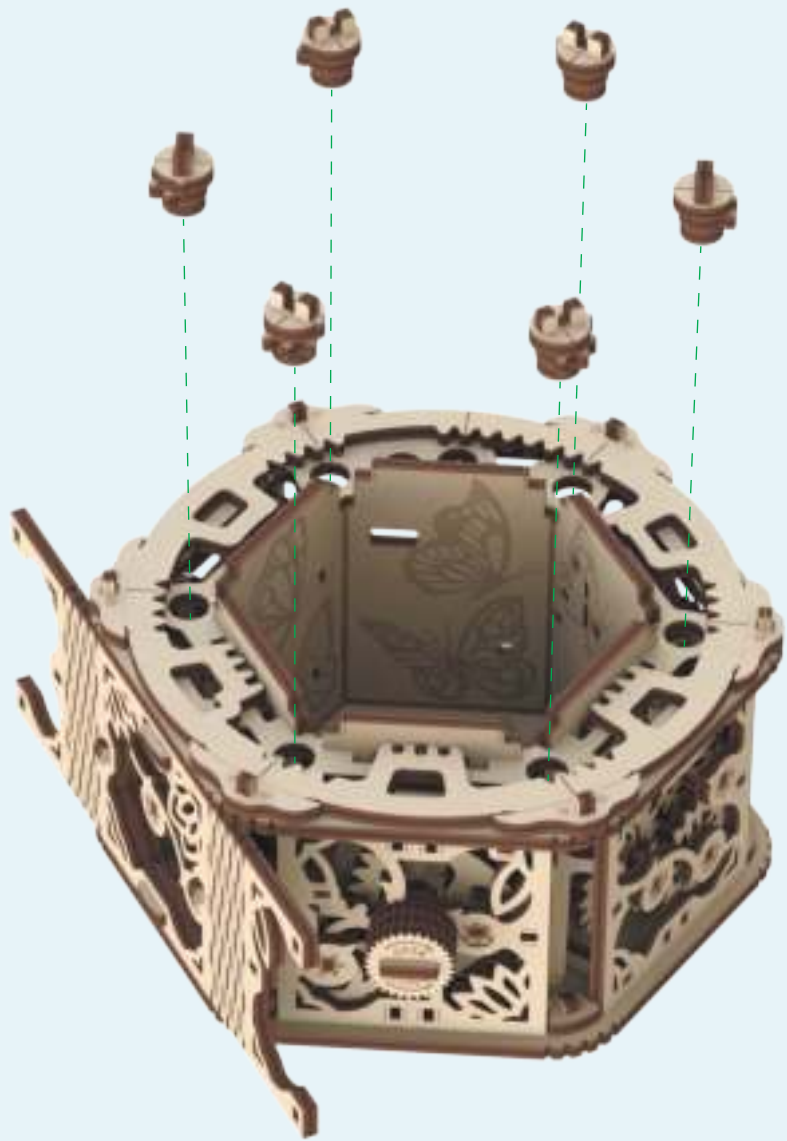

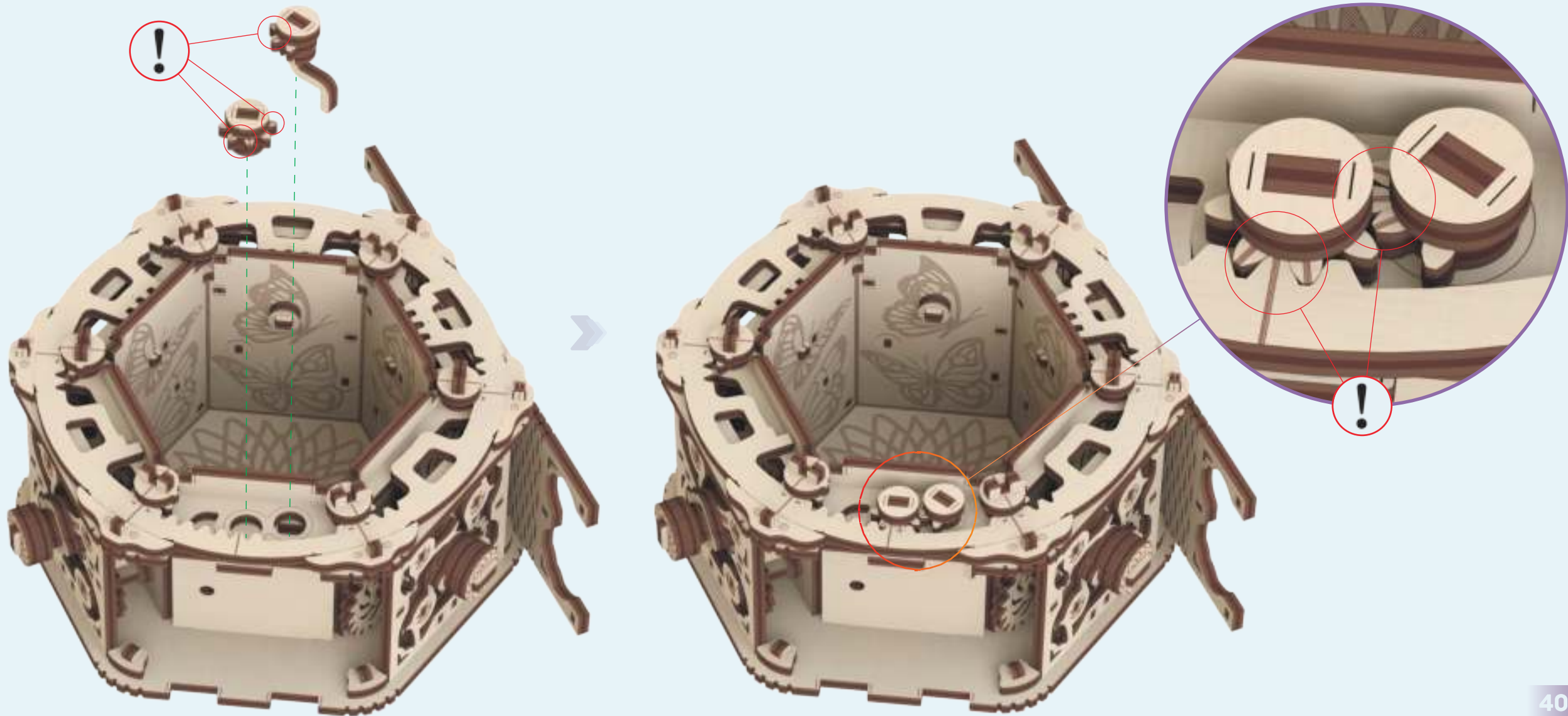

90

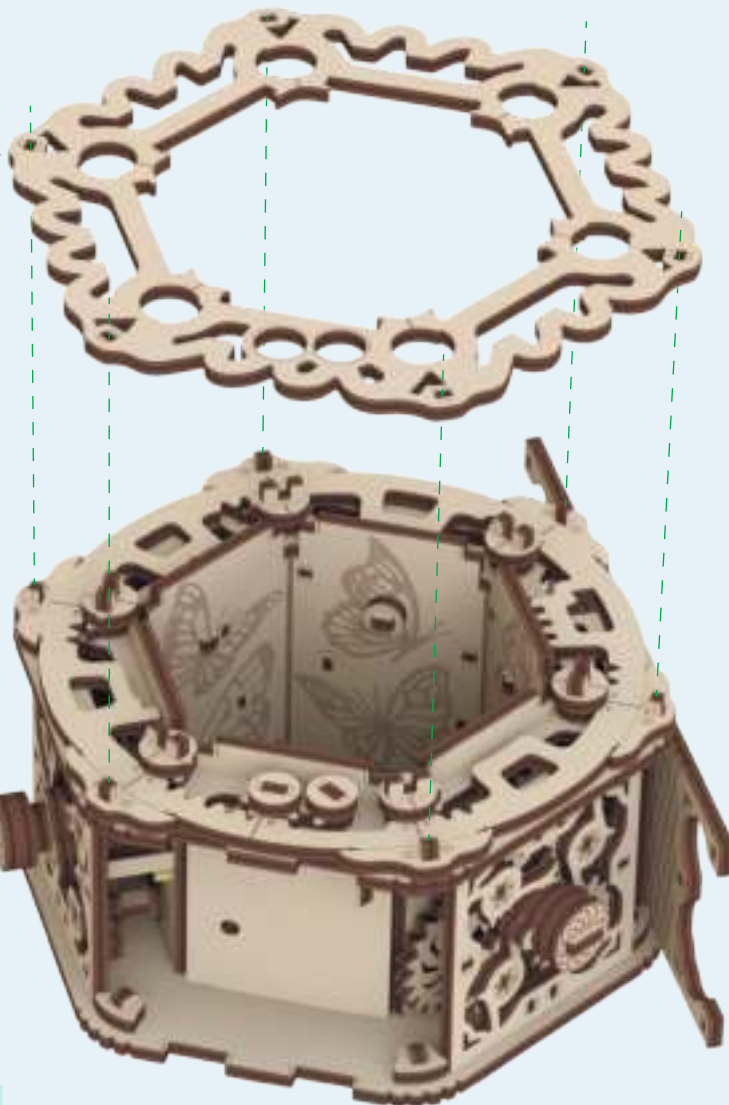

EN These elements must be made to work in turn using the wrench. All elements must rotate freely.

UA Дані елементи необхідно розробити за допомогою ключа по черговості. Усі елементи повинні вільно обертатися.

DE Diese Elemente müssen mit einem Schlüssel der Reihe nach entwickelt werden. Alle Elemente müssen sich frei drehen lassen.

FR Ces éléments doivent faire travailler en utilisant la clé tour à tour. Tous les éléments doivent tourner librement.

ITL Questi elementi devono essere lavorati usando una chiave in sequenza. Tutti gli elementi devono ruotare liberamente.

SP Los elementos dados es necesario trabajarlos con ayuda de la llave por la sucesión. Todos los elementos deben girar con soltura.

PL Elementy te muszą być z kolej urobione za pomocą klucza. Wszystkie elementy muszą się swobodnie obracać.

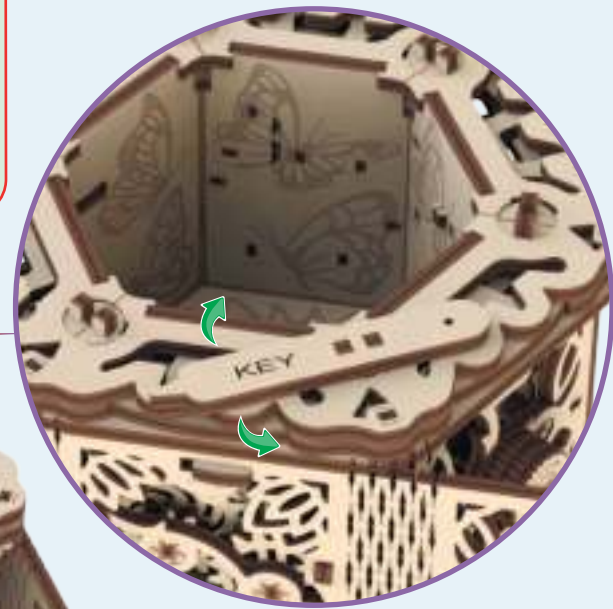

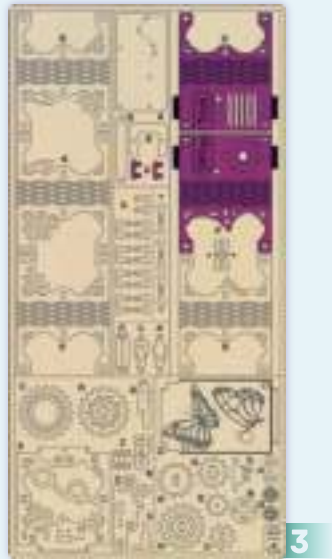

91

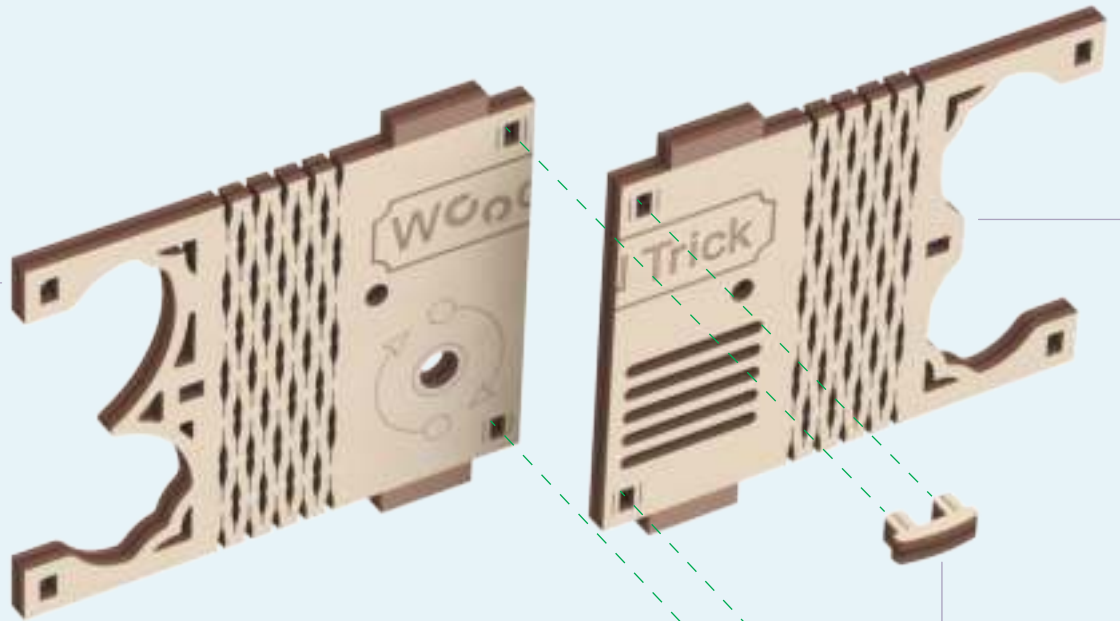

92

93

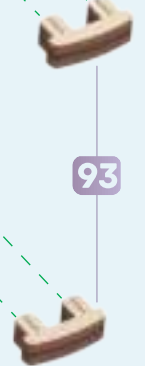

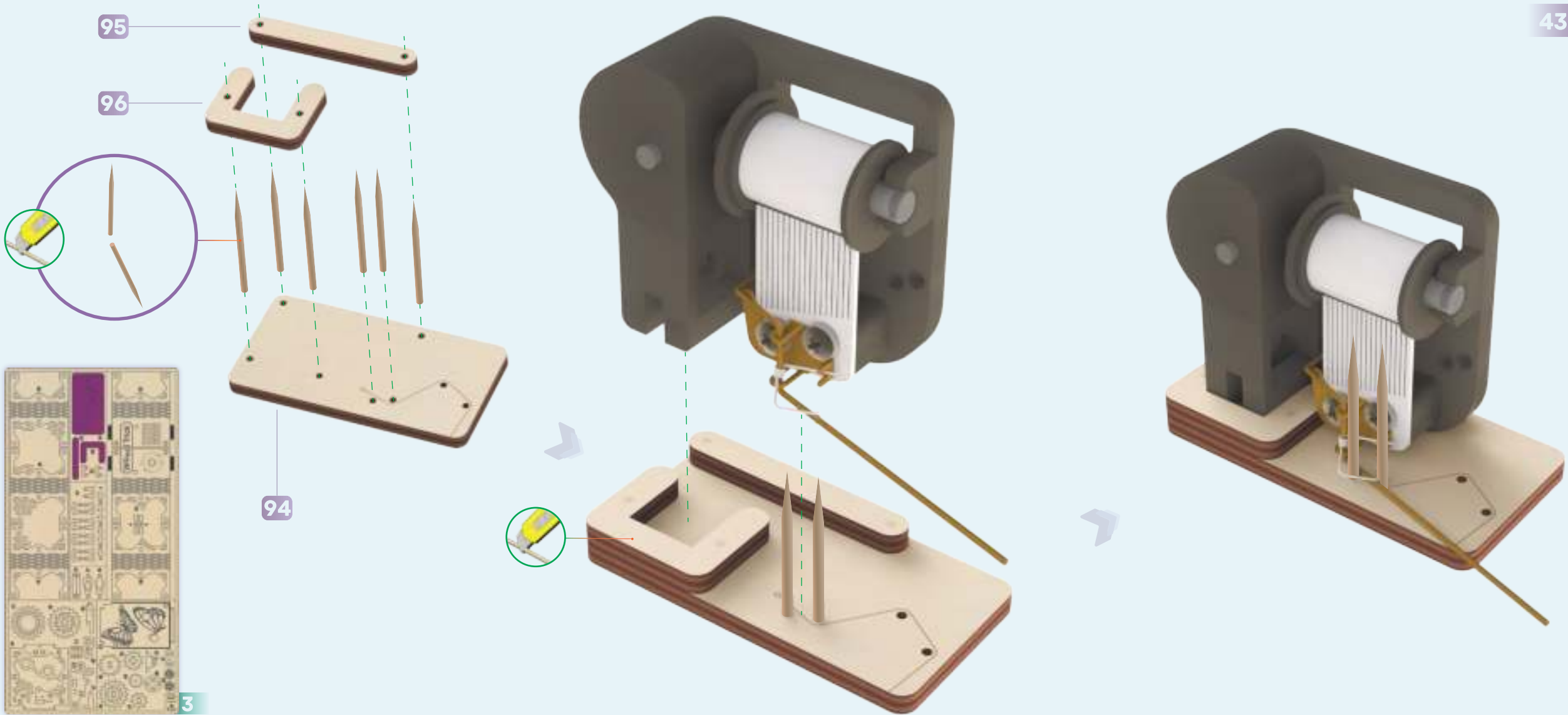

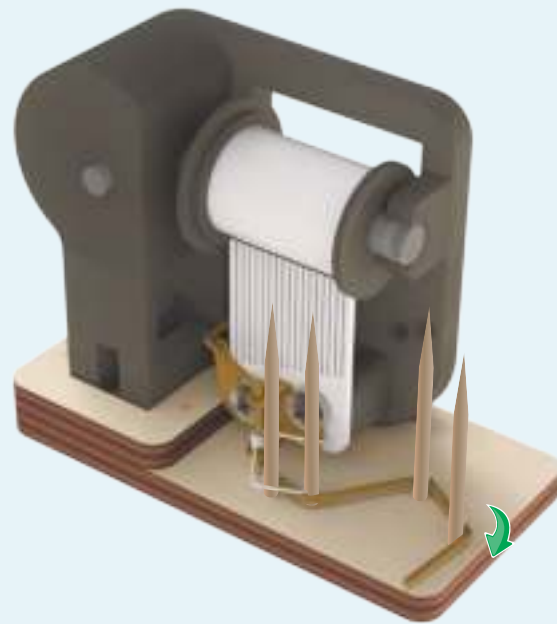
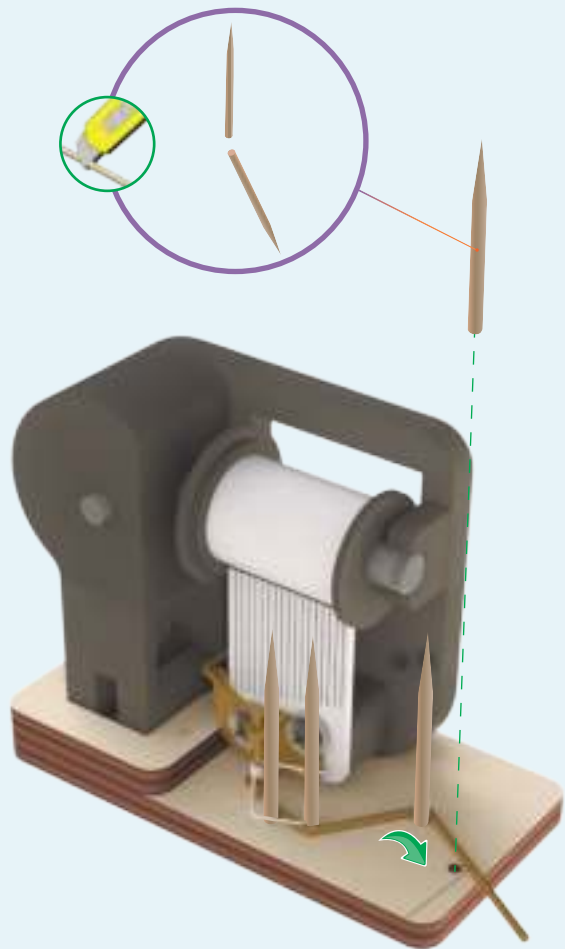
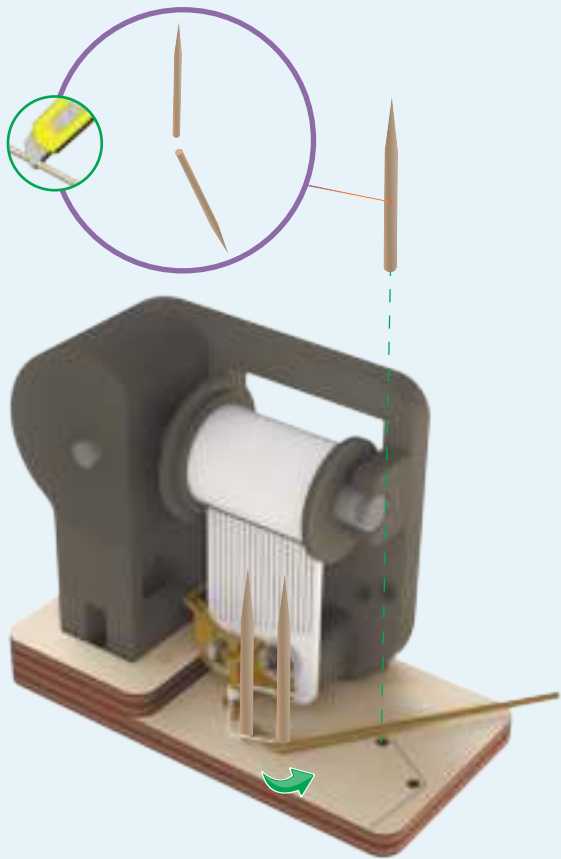

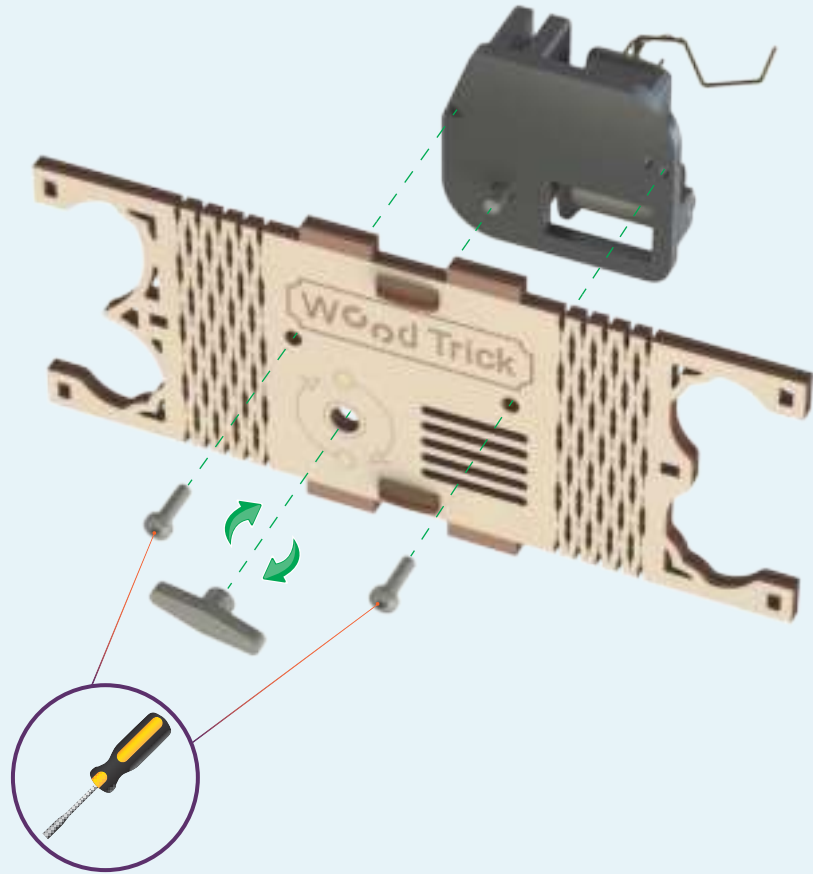
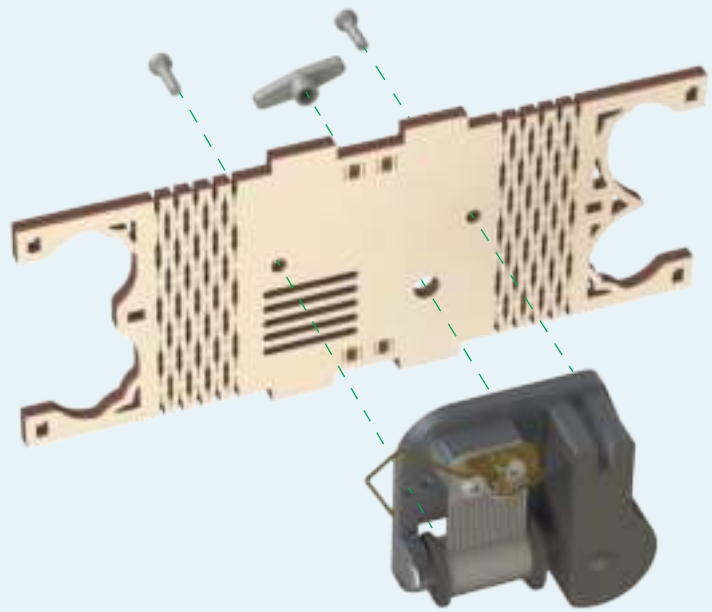

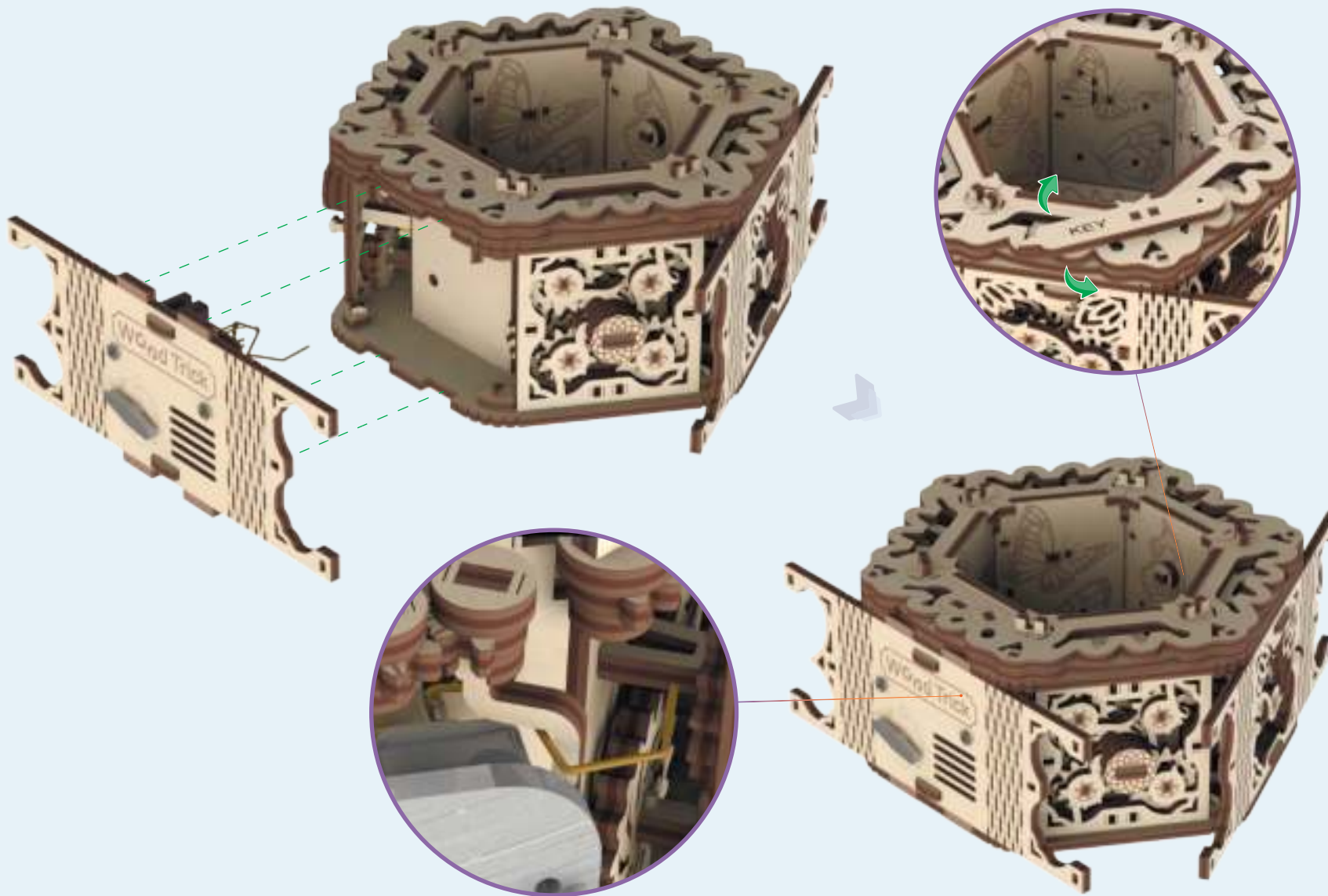

EN In order to verify the correct installation of the music mechanism: wind it up and turn the key clockwise until it stops, the melody should play. Turn the key counterclockwise to stop the music mechanism.
If the music mechanism does not work: check if the music mechanism is installed correctly.

UA Щоб перевірити правильність установки музичного механізму: заведіть його і поверніть ключ за годинниковою стрілкою до упору, повинна грати мелодія. Поверніть ключ проти годинникової стрілки, щоб припинити роботу музичного механізму.
Якщо музичний механізм не працює, перевірте правильність встановлення механізму.

FR Pour vérifier la bonne installation du mécanisme boîte à musique : remontez-le et tournez la clé dans le sens des aiguilles d'une montre jusqu'à ce qu'elle s'arrête, une mélodie doit jouer.
Tournez la clé dans le sens antihoraire pour arrêter le mécanisme boîte à musique. Si le mécanisme boîte à musique ne fonctionne pas : vérifiez que le mécanisme est correctement installé.

ITL Per verificare la corretta installazione del meccanismo musicale bisogna avviarlo, ruotare la chiave in senso orario fino in fondo finché non si sente la musica.
Per arrestare il meccanismo musicale bisogna ruotare la chiave in senso antiorario. In caso di non funzionamento del meccanismo musicale verificare che il meccanismo sia installato correttamente.

DE Um die Richtigkeit die Einstellungen des Musikmechanismus zu überprüfen, müssen Sie den Mechanismus starten und den Schlüssel im Uhrzeigersinn ganz nach rechts drehen. Die Melodie sollte spielen.
Drehen Sie den Schlüssel gegen den Uhrzeigersinn, um den Musikmechanismus zu stoppen.
Wenn der Musikmechanismus nicht funktioniert: überprüfen Sie, ob der Mechanismus richtig eingestellt ist.

PL W celu sprawdzenia poprawności ustawienia mechanizmu muzycznego: uruchom mechanizm i obróć klucz zgodnie ze wskazówkami zegara w prawo do końca, powinna zagrać melodia.
Obróć klucz w kierunku przeciwnym do ruchu wskazówek zegara, aby zatrzymać mechanizm muzyczny.
Jeśli mechanizm muzyczny nie działa: sprawdź, czy mechanizm jest prawidłowo ustawiony.

SP Para verificar la instalación correcta del mecanismo musical hace falta ponerlo en marcha y girar la llave en sentido horario hasta llegar al tope, debe sonar una melodía.
Gire la llave en sentido antihorario para deshabilitar el mecanismo musical.
Si el mecanismo musical no funciona, verifique que el mecanismo esté instalado correctamente.



3

4

4

97



3

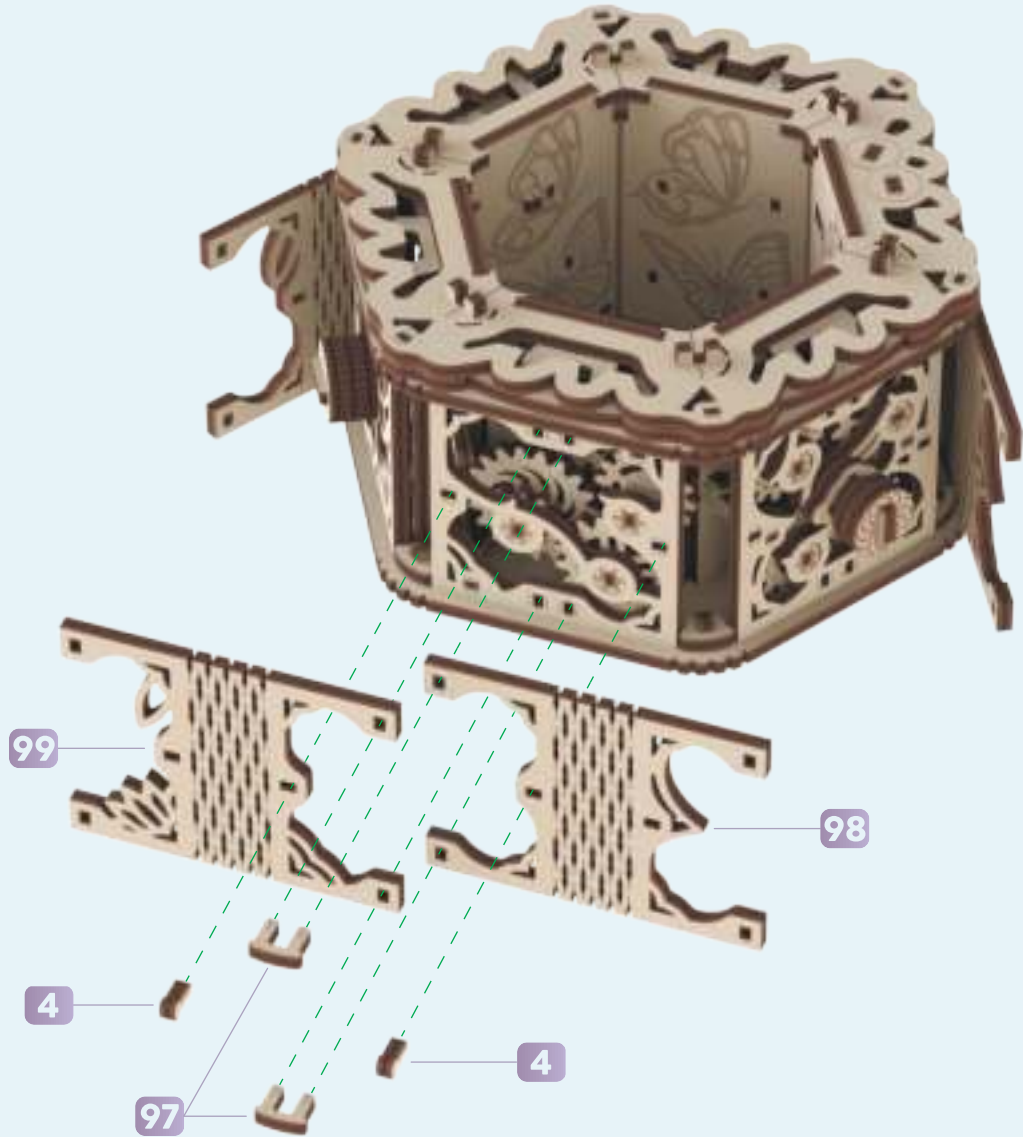

99

98

4

4

97







100x6



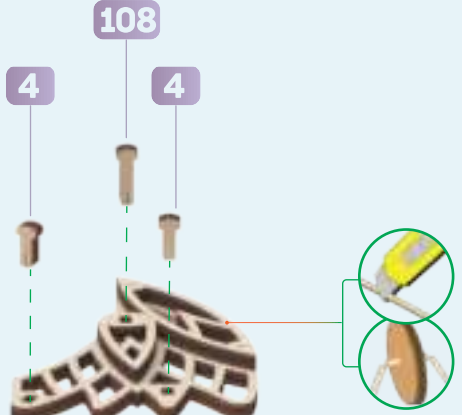
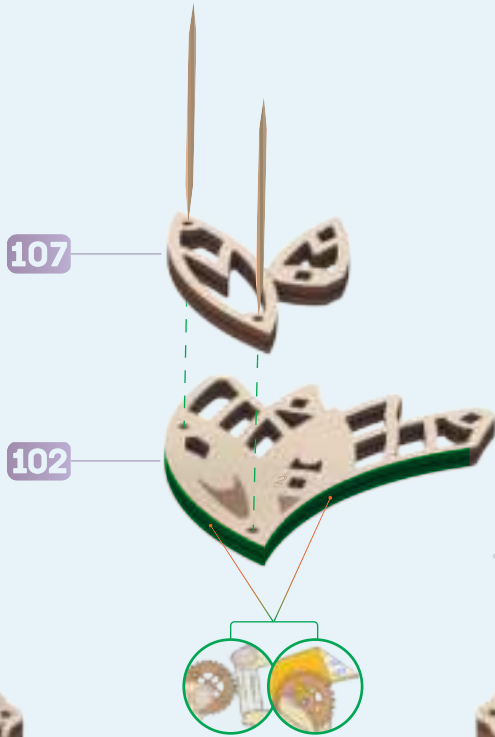
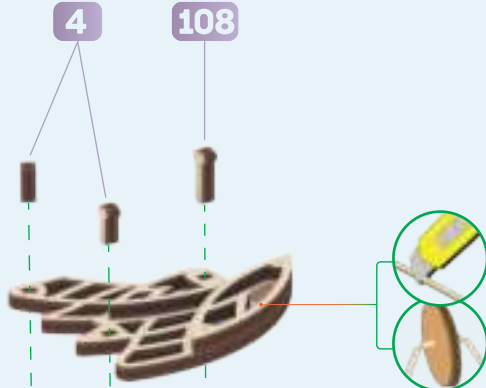
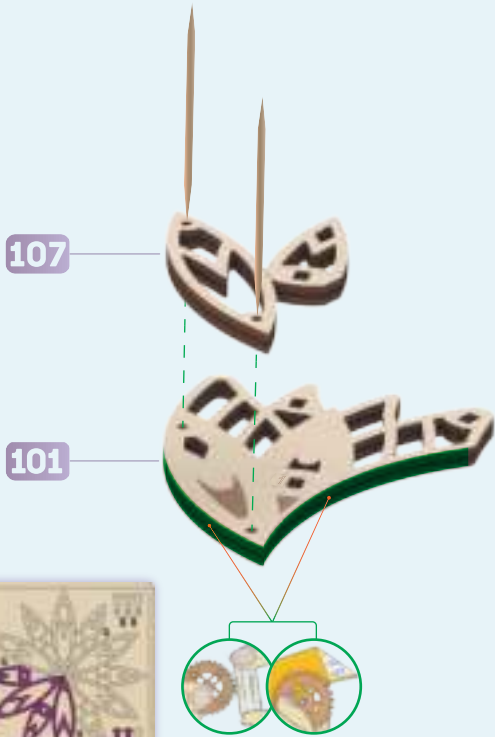

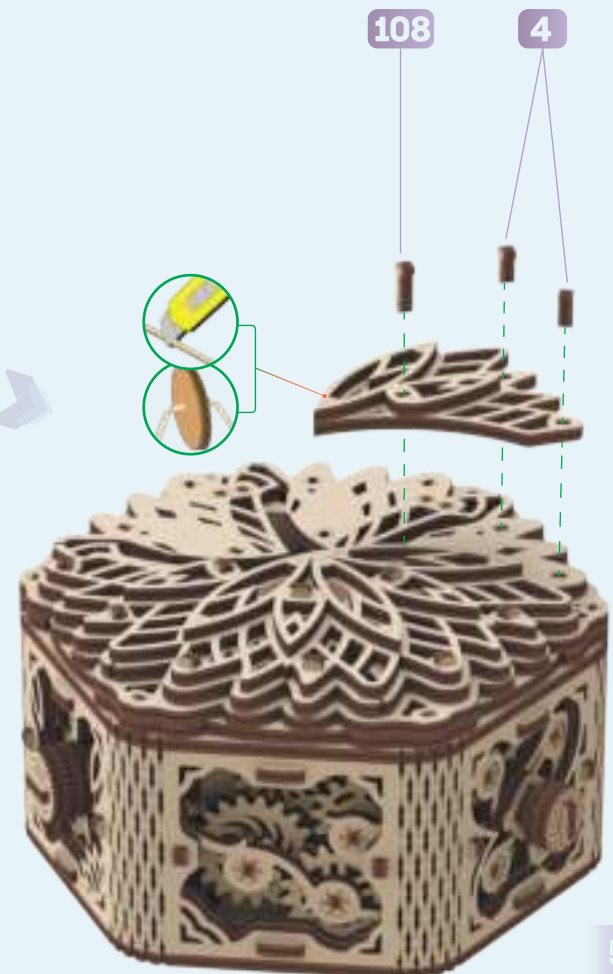
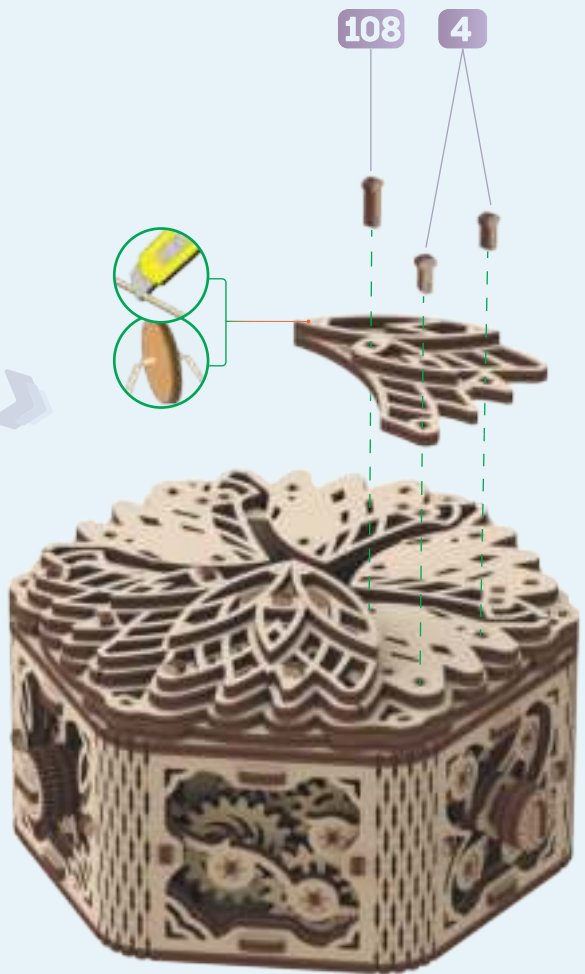
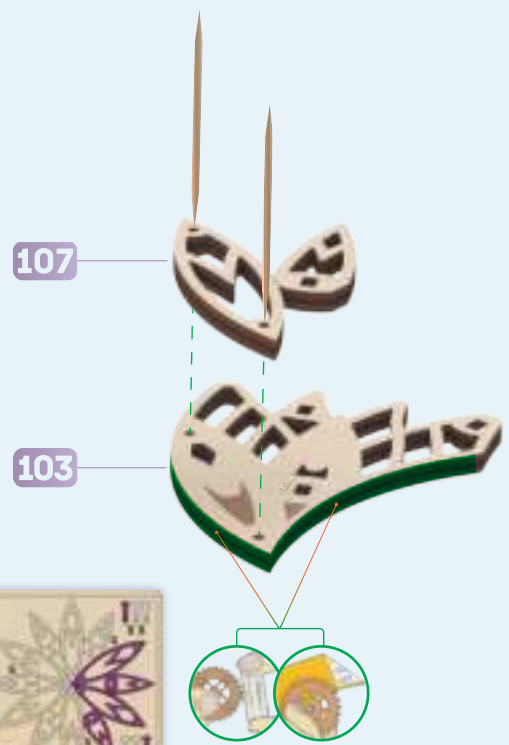
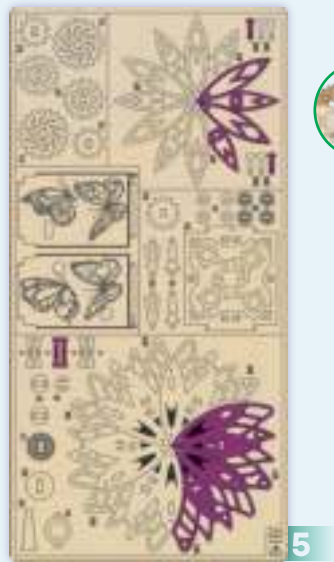

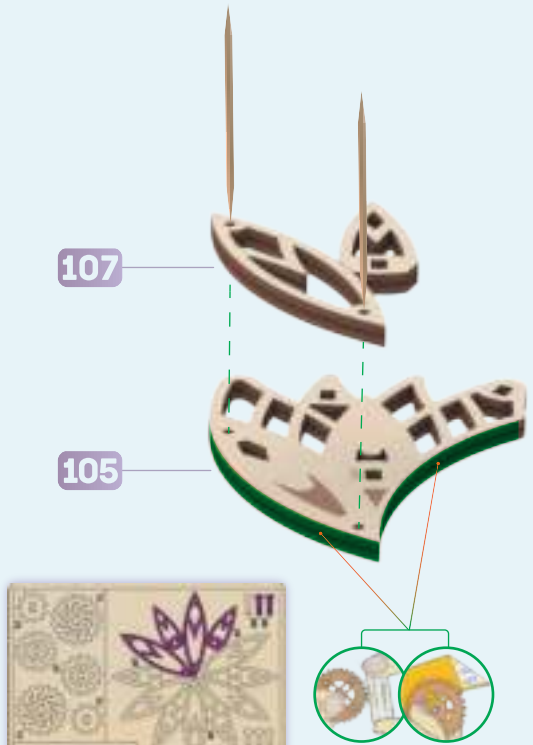

5

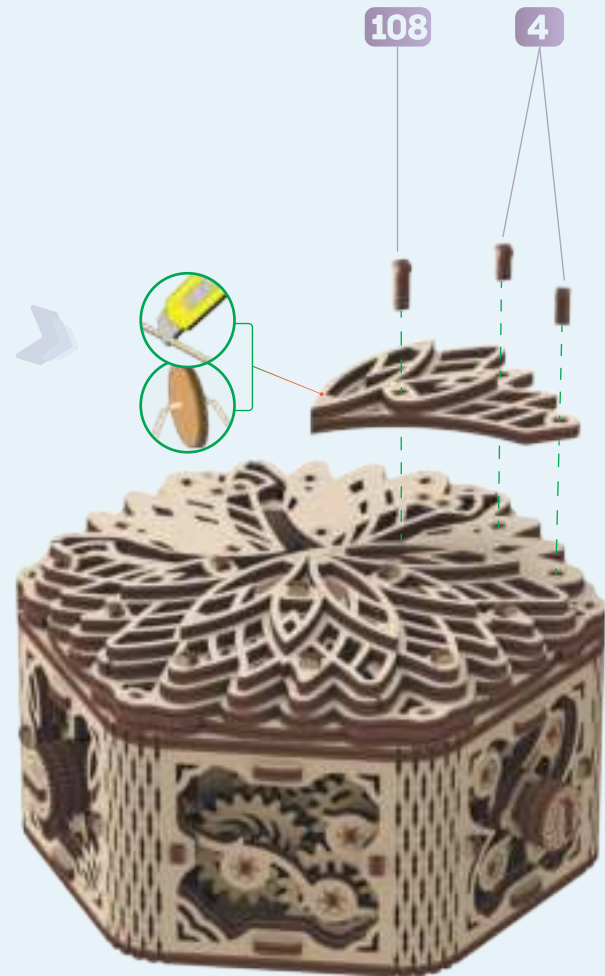
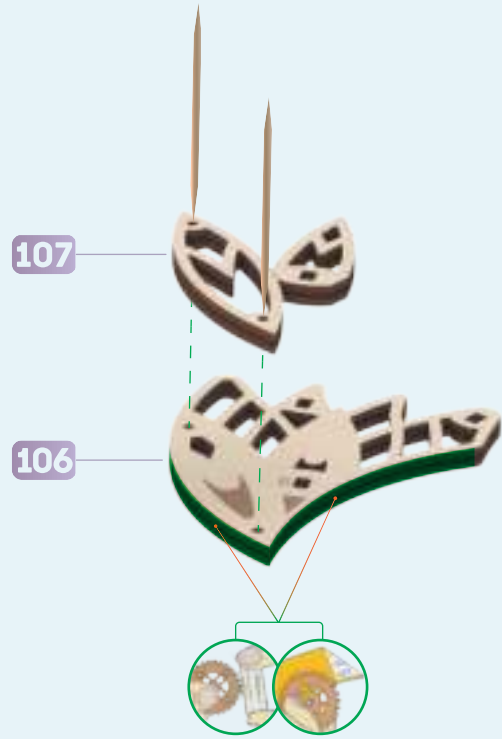



CLICK

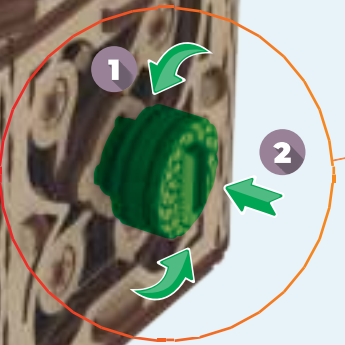



EN To open the box, follow these steps:

1. Pull the handle towards you, turn clockwise 90 degrees.
2. Slide the switch all the way to the right.
3. Move the lever up until it clicks.
4. Turn the handle clockwise until fully open.

To close the box, repeat steps № 4,2,1 in reverse order.

When closing the box, step № 3 is performed automatically.

UA Для відкриття шкатулки, необхідно виконати наступні кроки:

1. Потягнути ручку на себе, повернути за годинниковою стрілкою на 90 градусів.
2. Зрушити перемикач до упору вправо.
3. Підняти важіль до клацання.
4. Повернути ручку за годинниковою стрілкою до повного відкриття.

Для закриття шкатулки повторіть кроки № 4,2,1 в зворотному порядку.

При закритті шкатулки крок №3 виконується автоматично.

SP Para abrir el estuche es necesario hacer los pasos siguientes:

1. Tirar la manivela hacia sí, girarla en sentido horario a 90 grados.
2. Mover el interruptor hasta el extremo a la derecha.
3. Levantar la palanca hasta oír el capirotazo.
4. Hacer girar la manivela en sentido horario hasta lograr la apertura completa.

Para el cierre del estuche repita los pasos № 4, 2, 1 en el orden inverso.

Al cierre del estuche el paso №3 se hace automáticamente.

Para el cierre del estuche repita los pasos № 4, 2, 1 en el orden inverso.

Al cierre del estuche el paso №3 se hace automáticamente.

PL Aby otworzyć pudełko, należy wykonać następujące kroki:

1. Pociągnij uchwyt do siebie, obróć w prawo o 90 stopni.
2. Przesuń przełącznik maksymalnie w prawo.
3. Podnieś dźwignię, aż usłyszysz kliknięcie.
4. Obróć uchwyt w prawo, aż do całkowitego otwarcia.

Aby zamknąć pudełko, powtórz kroki nr 4,2,1 w odwrotnej kolejności.

Podczas zamykania pudełka krok Nr 3 jest wykonywany automatycznie.

DE Gehen Sie folgendermaßen vor, um das Kästchen zu öffnen:

1. Den Griff an sich ziehen und dann diesen um 90 Grad in der Uhrzeigersinn-Richtung drehen.
2. Den Schalter nach rechts bis zum Anschlag schieben.
3. Den Hebel anheben, bis ein Klicken hörbar ist.
4. Den Griff in der Uhrzeigersinn-Richtung, bis zum vollständigen Öffnen, drehen.

Um das Kästchen zu schließen, sind die Schritte Nr. 4,2,1 in einer umgekehrten Reihenfolge zu wiederholen.

Beim Kästchenschließen wird der Schritt Nr. 3 automatisch ausgeführt.

ITL Per aprire il cofanetto, attenersi alla seguente procedura:

1. Tirare la maniglia verso di sé, ruotare di 90 gradi in senso orario.
2. Far scorrere l'interruttore completamente a destra.
3. Sollevare la leva fino allo scatto.
4. Ruotare la maniglia in senso orario fino a quando non è completamente aperta.

Per chiudere il cofanetto, ripetere i passaggi n. 4,2,1 in ordine inverso.

Quando si chiude il cofanetto, il passaggio 3 viene eseguito automaticamente.

FR Pour ouvrir la boîte, procédez comme suit:

1. Tirez la poignée vers vous, tournez de 90 degrés dans le sens des aiguilles d'une montre.
 2. Faites glisser le commutateur en butée vers la droite.
 3. Soulevez le levier jusqu'à ce qu'il s'enclenche.
 4. Tournez la poignée dans le sens des aiguilles d'une montre jusqu'à ce qu'elle soit complètement ouverte.
- Pour fermer la boîte, répétez les étapes n°4,2,1 dans l'ordre inverse.

Lors de la fermeture de la boîte, l'étape n°3 est effectuée automatiquement.





Let the music play

Beethoven's famous melody "To Elise" is most often associated with only one thing: music boxes. We decided not to deviate from tradition, so it's the tune that plays in our Mystery Flower Music Box. You can assemble it with your own hands. The intricate patterns on the box's lid will delight your eye each time you take the jewelry out of the box.



THE 18TH CENTURY

The century in which the world's first music box that played melodies was created. Antoine Favre was the inventor and Switzerland was the birthplace. In the 19th century, the country even established a factory to produce music boxes.

Follow us on
YouTube /woodtrick
Instagram @woodtrick
www.woodtrick.com

NOT JUST A SOUVENIR

Initially, music boxes could only play music, but eventually, they became jewelry boxes with music mechanism. So now, these boxes are highly suitable for storing jewelry and small valuables, as well as for aesthetic and recreational purposes.

A SIMPLE MECHANISM

The music box is based on a simple mechanism. It consists of a mechanism with combs, a cylinder, and a knob, which must be wound until the tune plays. The combs hook onto pins on the drum, and the melody plays while the cylinder returns to its original position.

WOOD TRICK

CHECK OUT OTHER SERIES



SPECIAL FORCES SERIES



MODERN MACHINERY SERIES

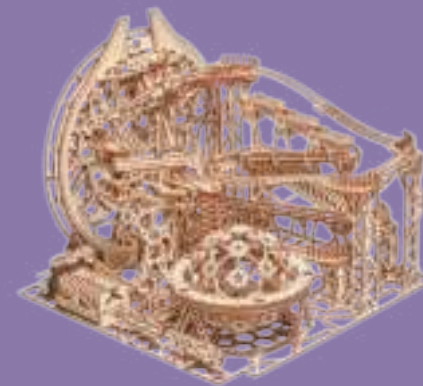

ELECTRIC SERIES



VINTAGE MACHINERY SERIES