

WOOD TRICK

ENGINEERING
J00000000004

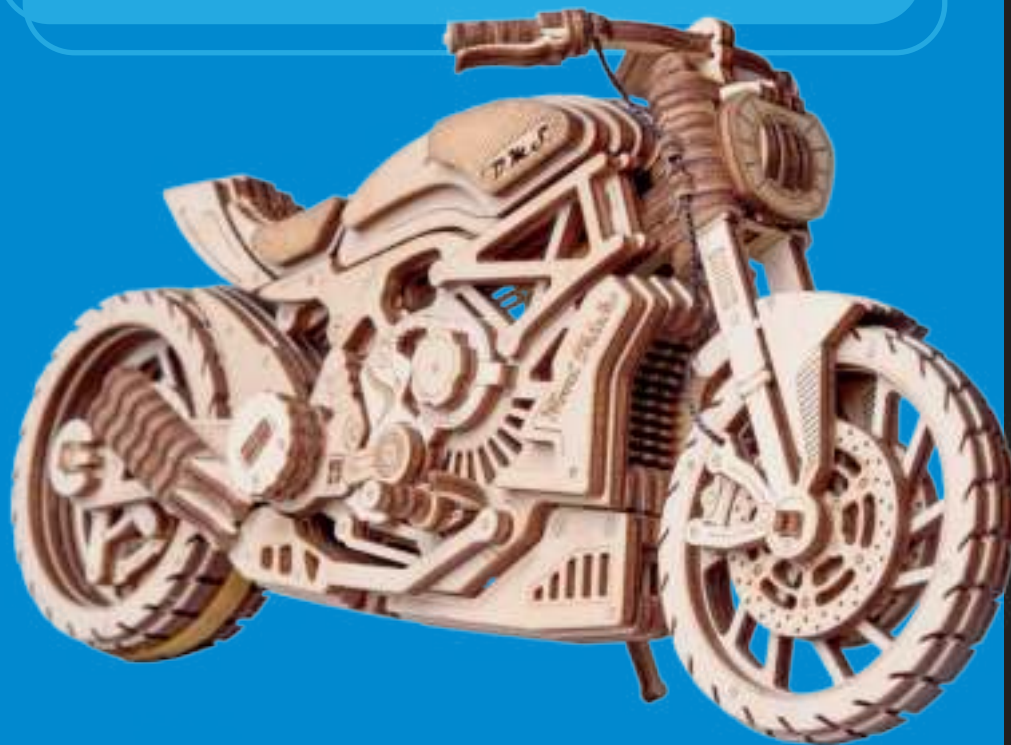

MODERN
MACHINERY
SERIES

MECHANICAL MODELS & KITS
**MOTORCYCLE
DMS**

Progress indicator: 5 circles, 3 filled, 2 empty.

LEVEL 3

203
PIECES

WDTK003

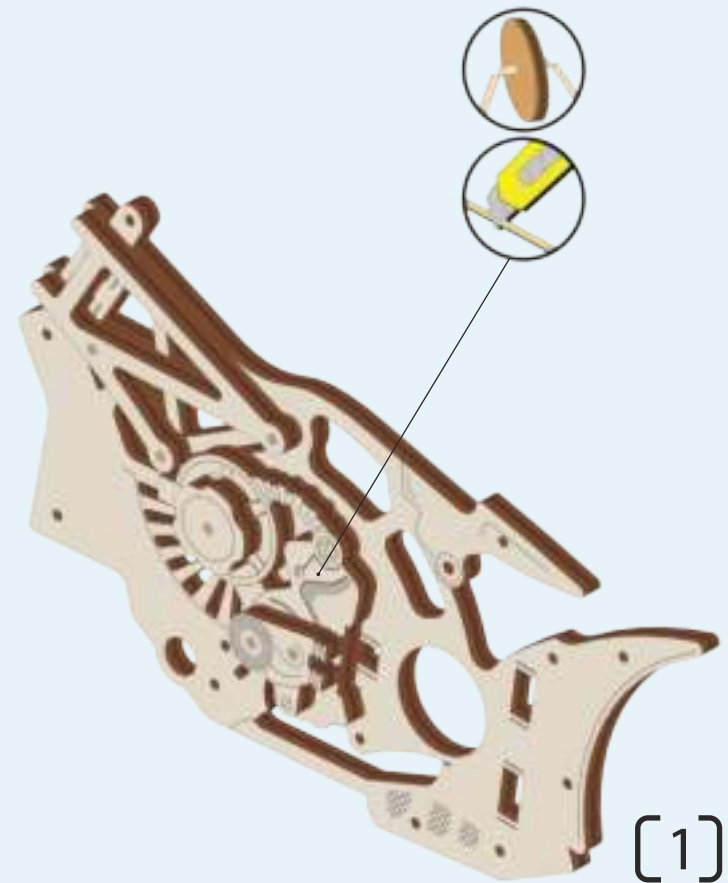
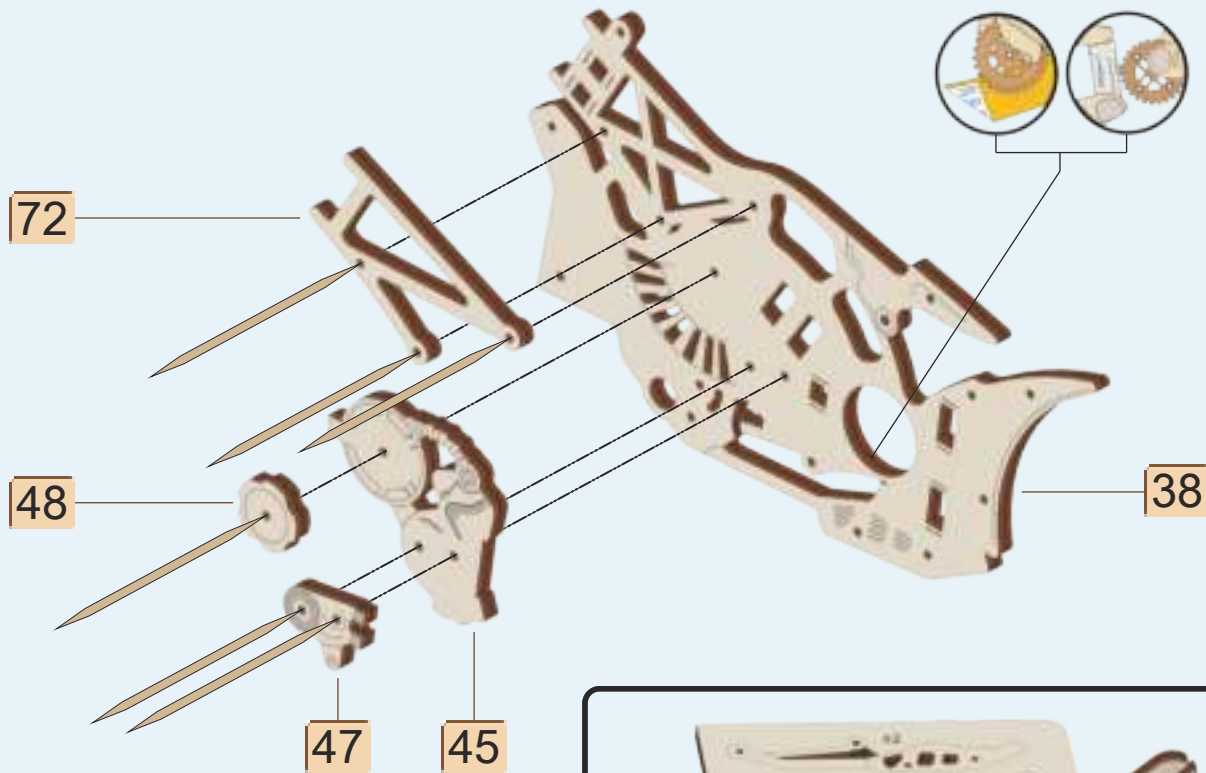



3

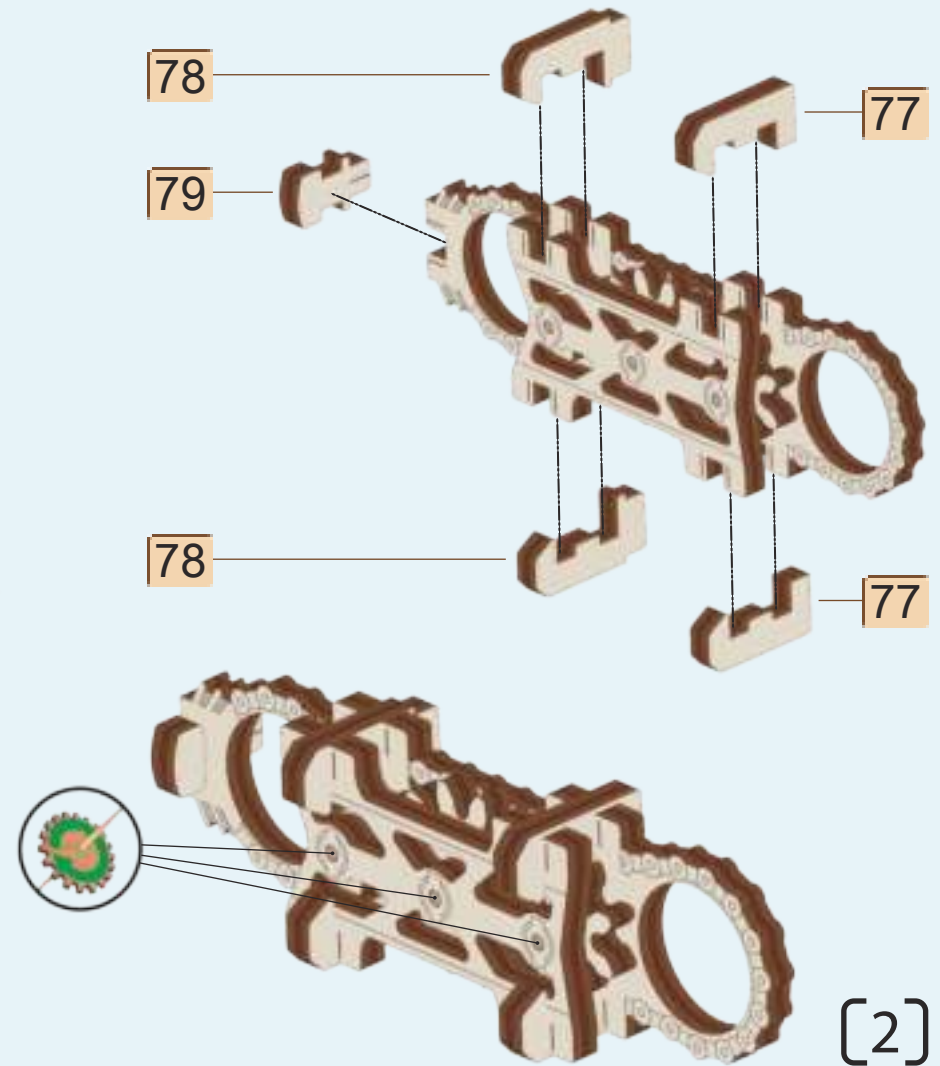
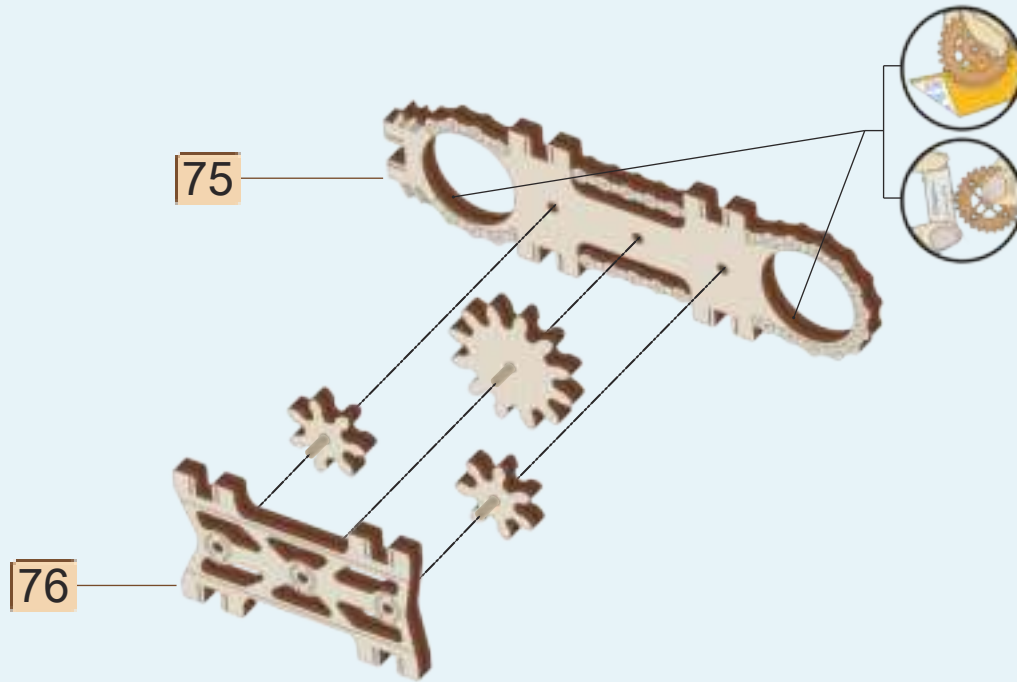
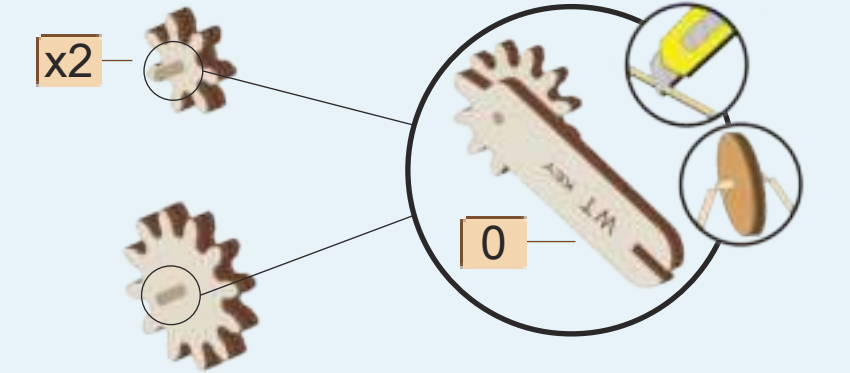
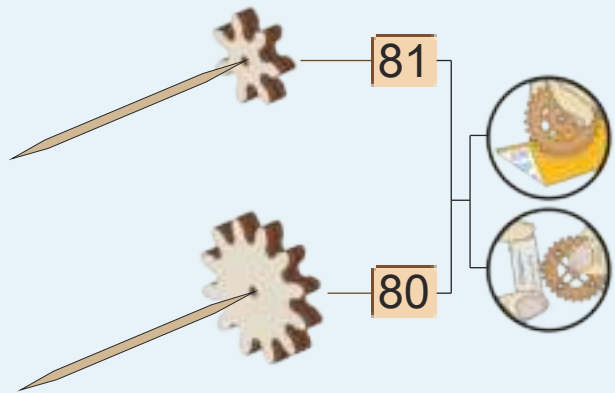

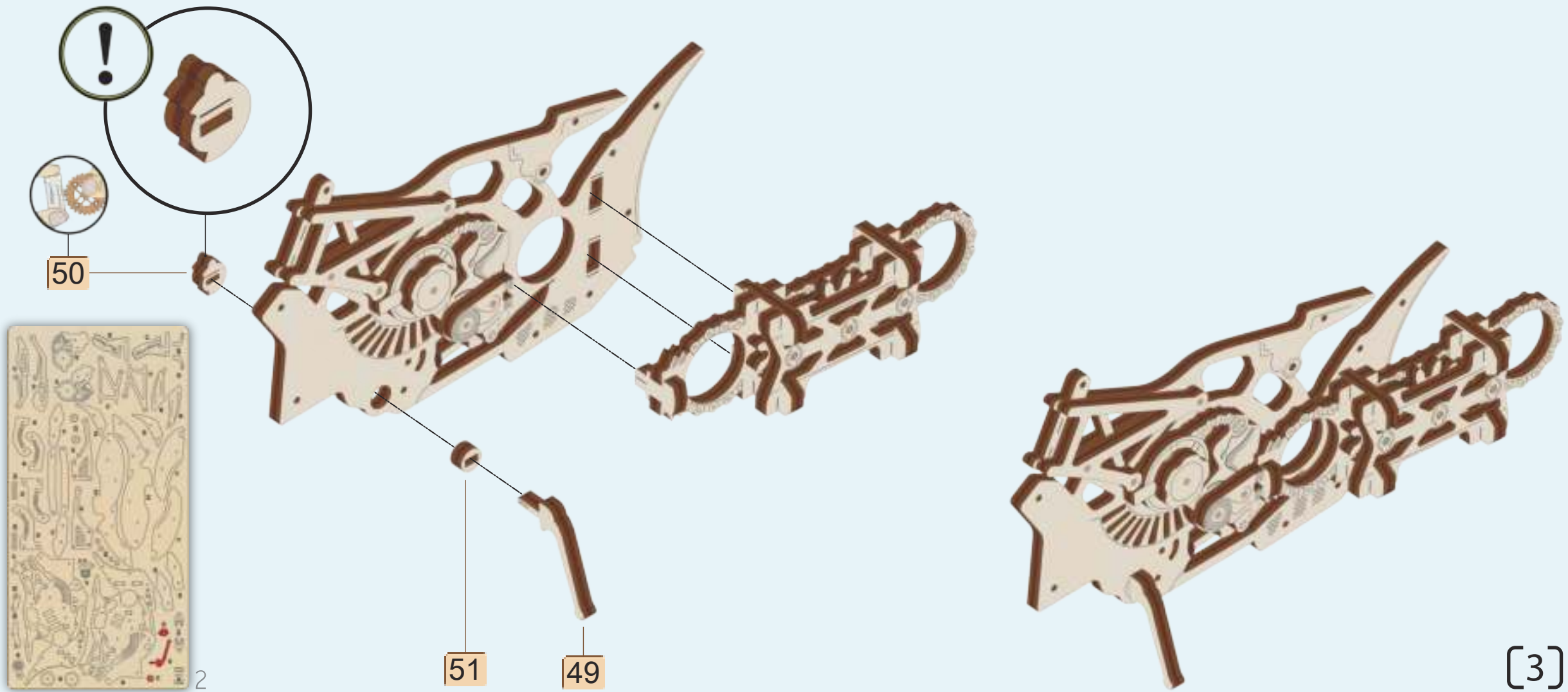



2

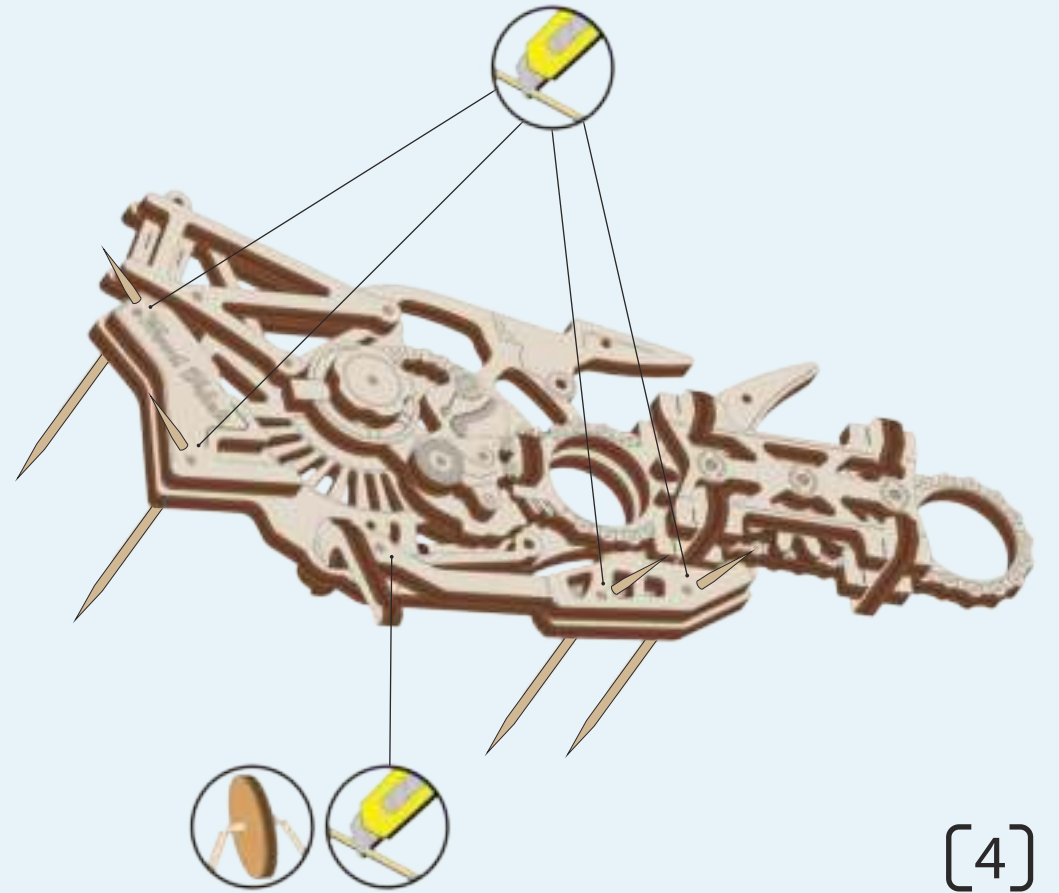
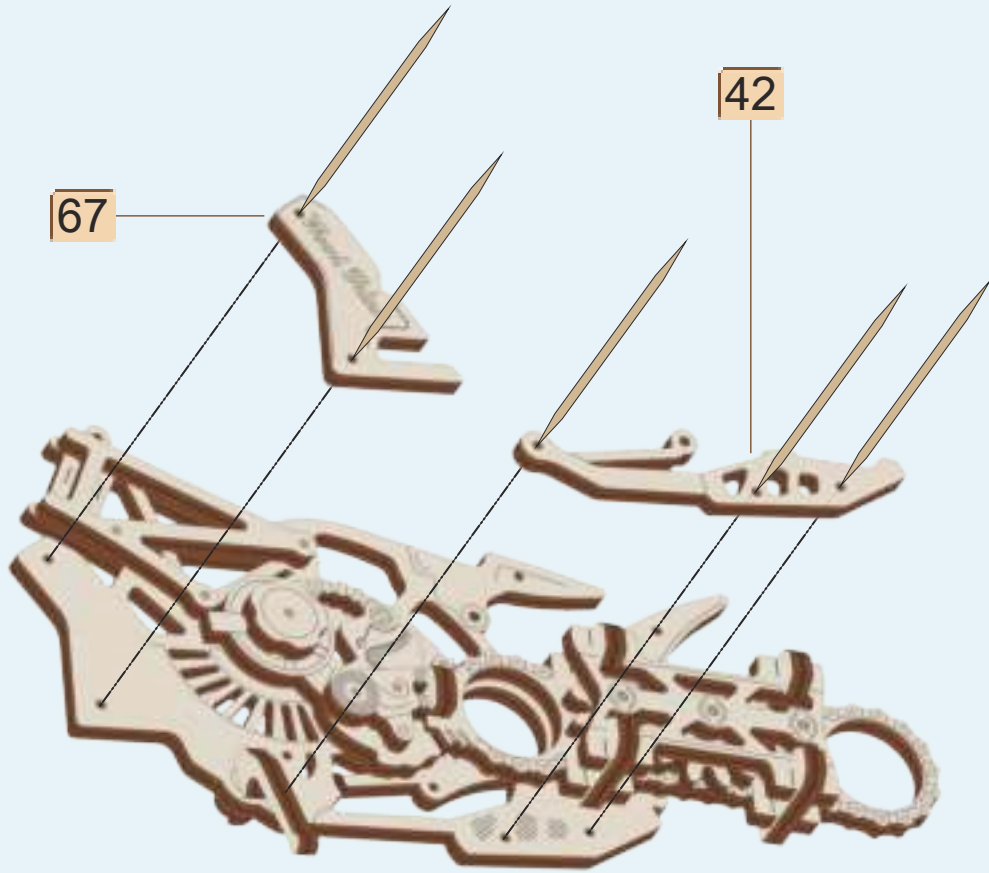

[4]

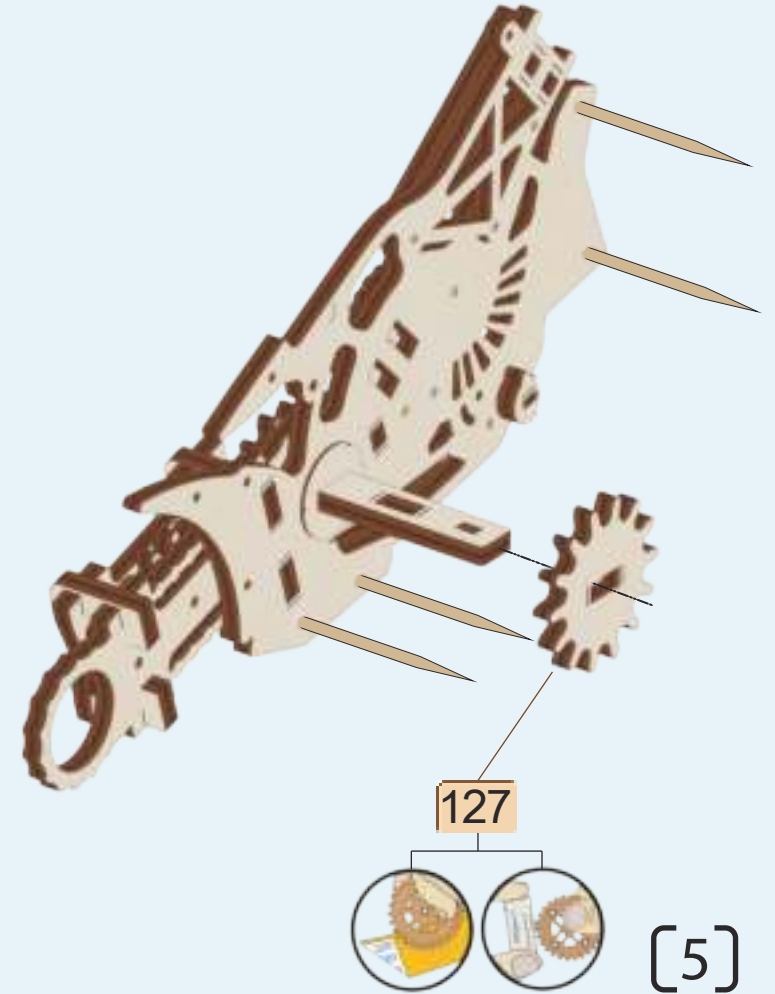
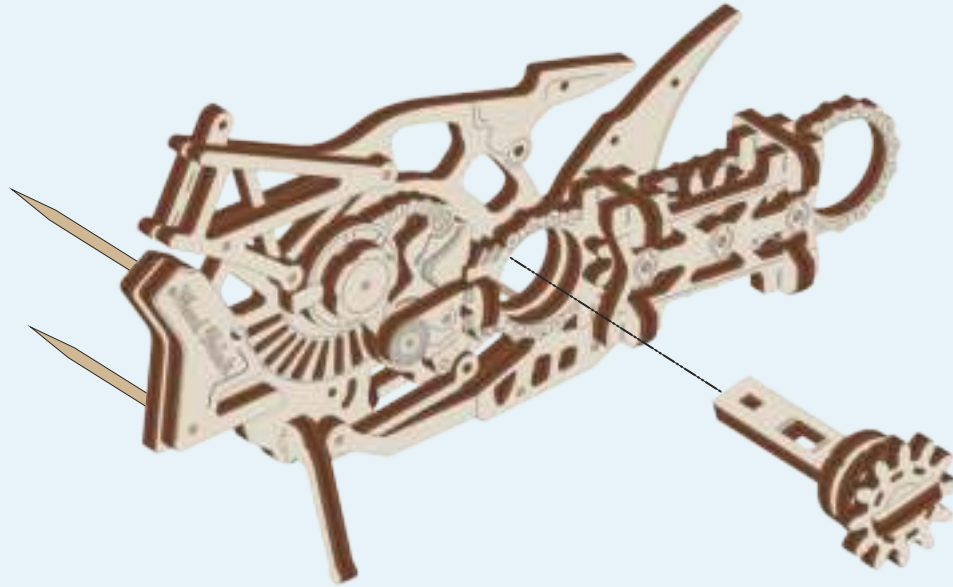
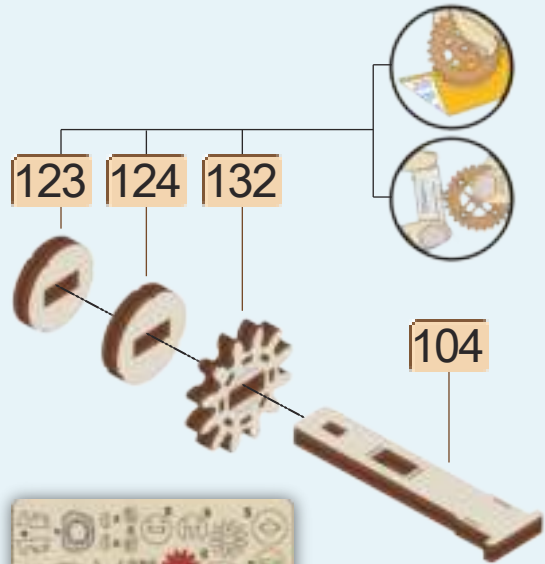

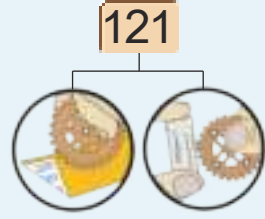
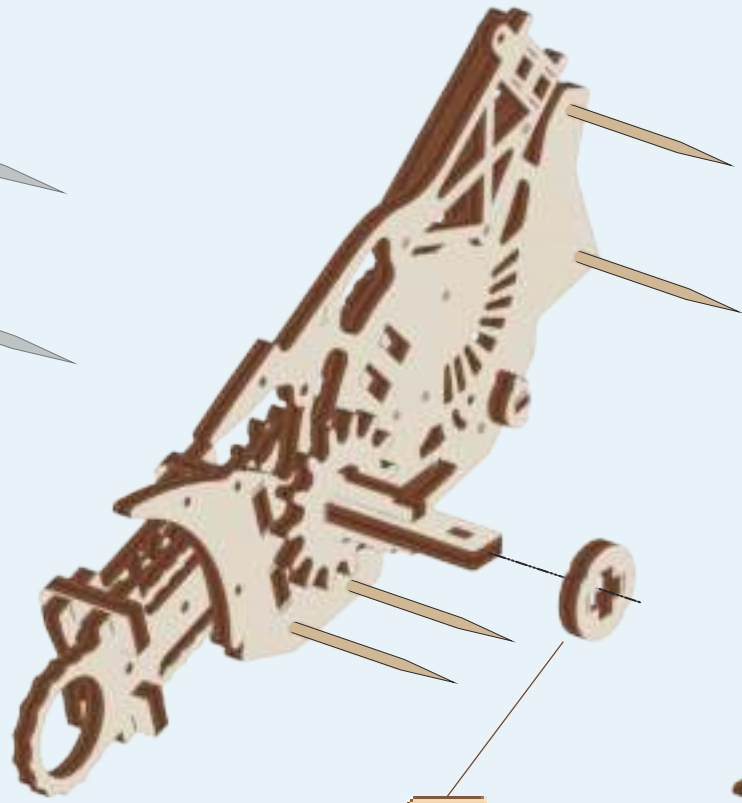

[6]

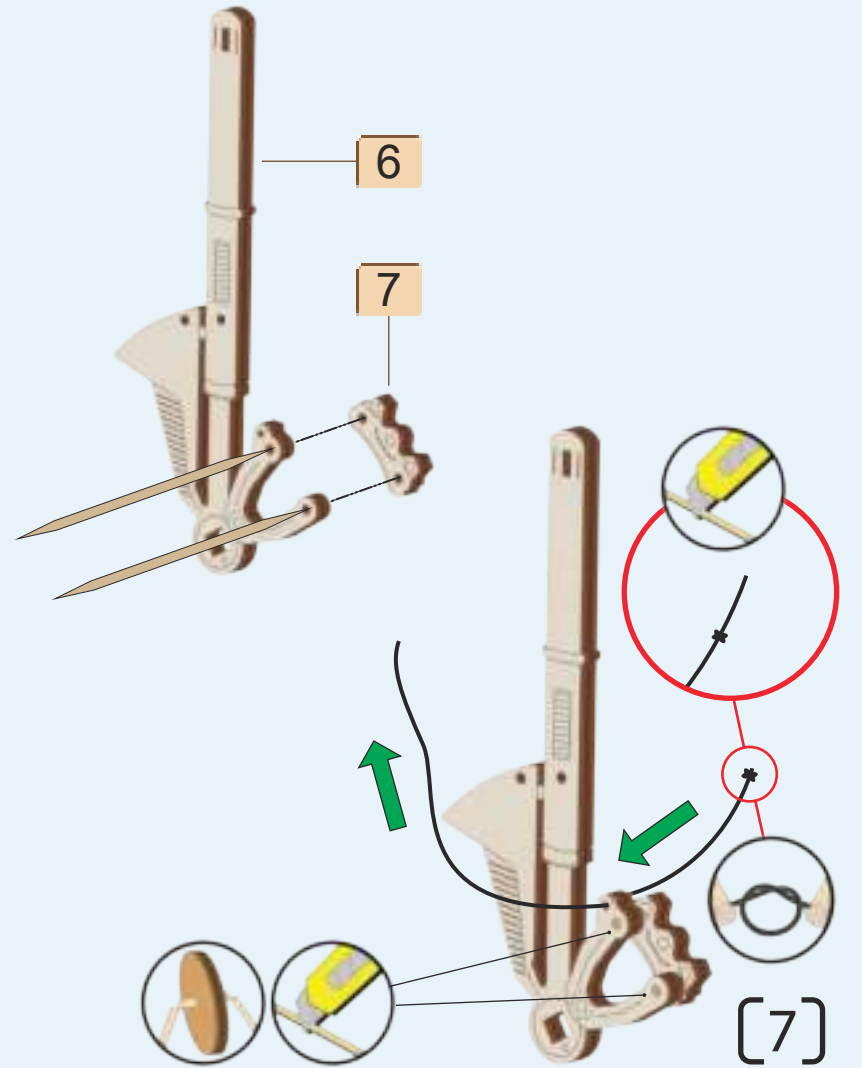
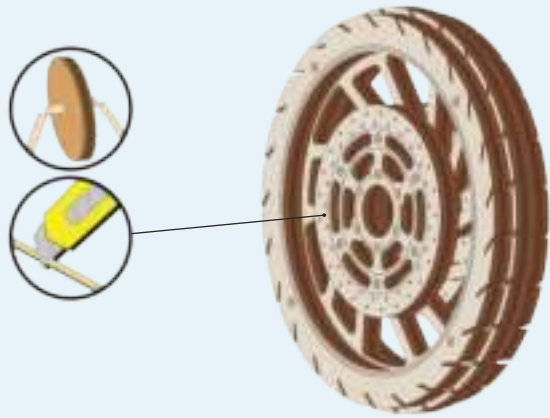
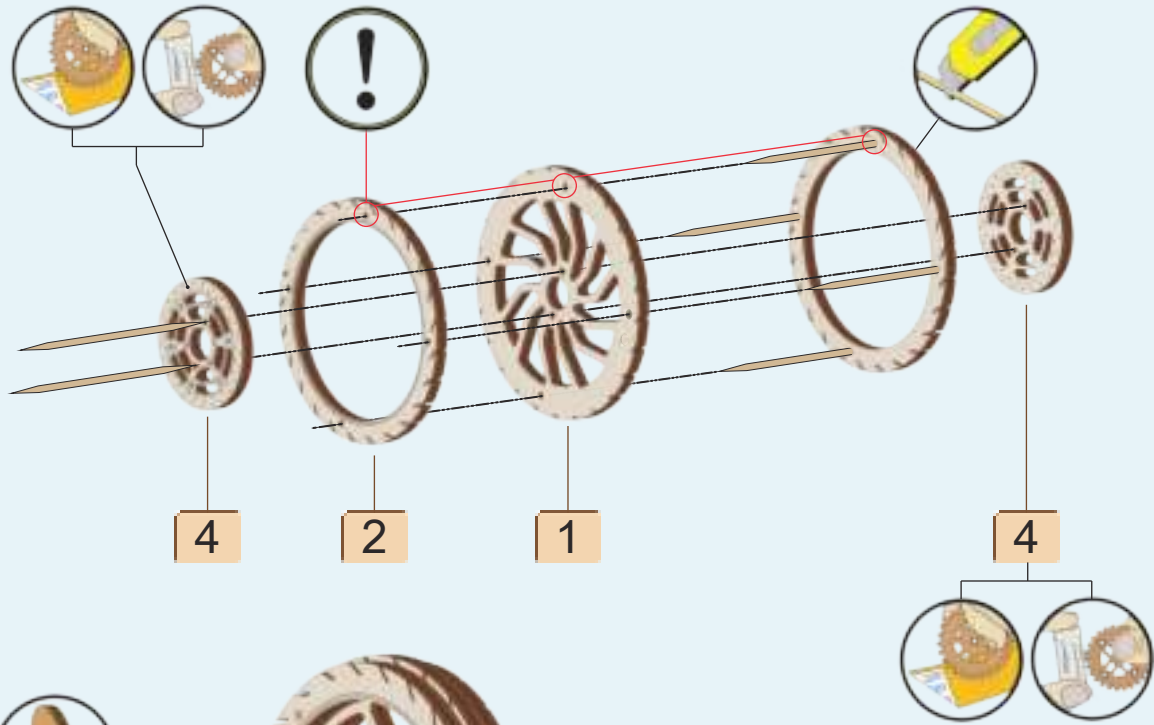
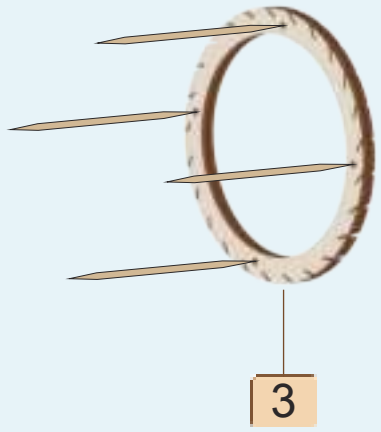

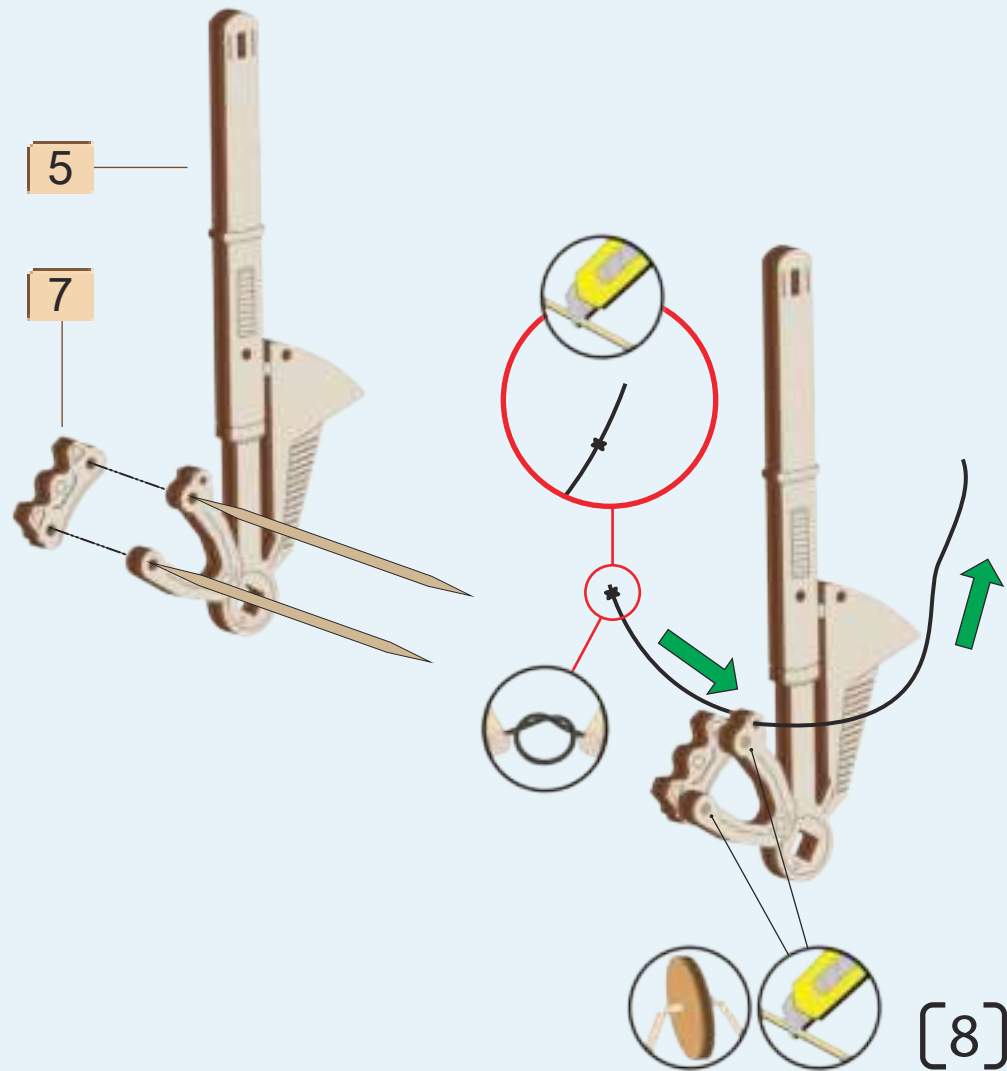
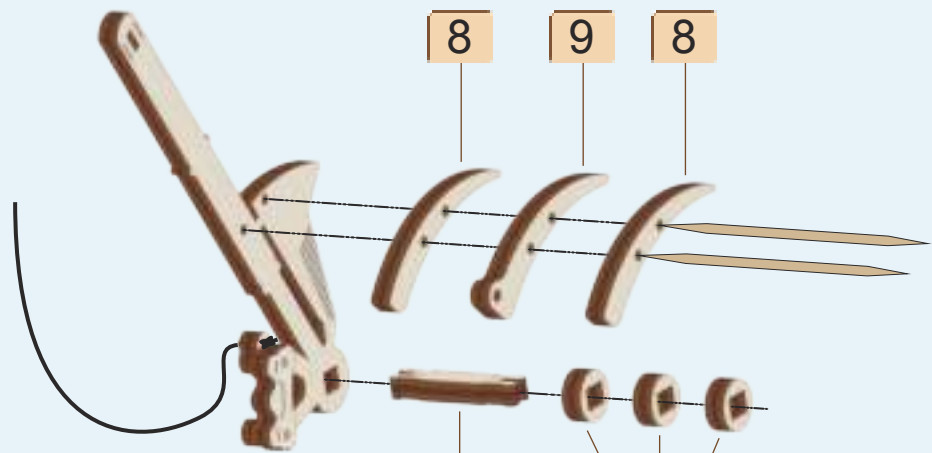

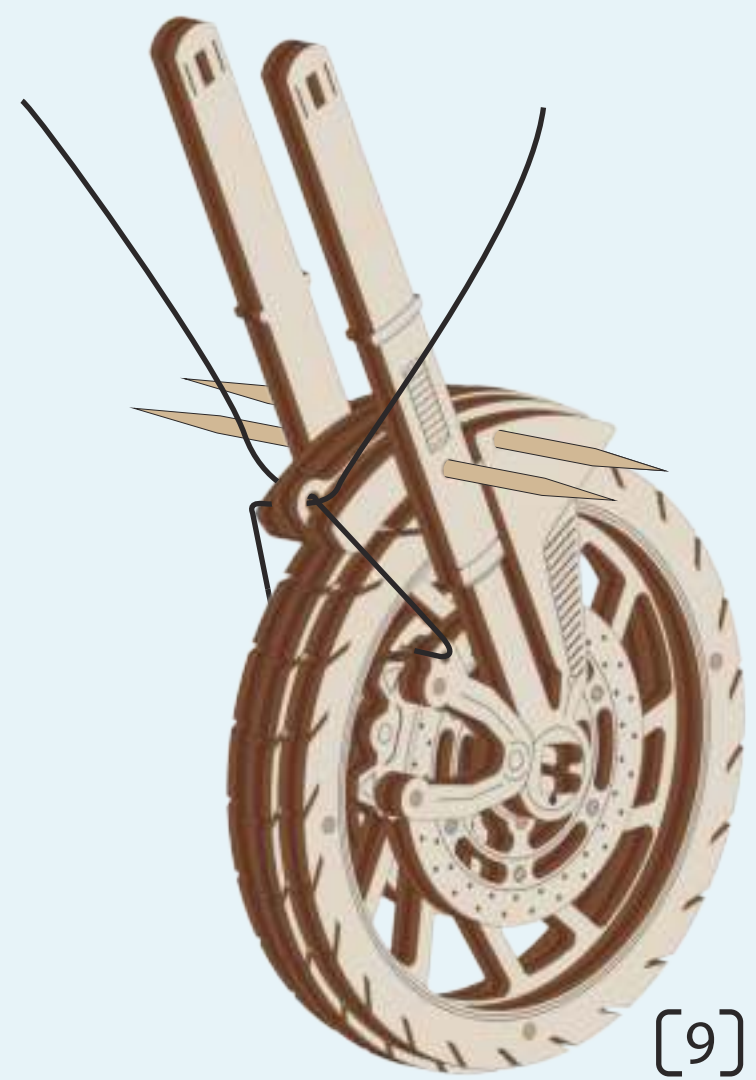
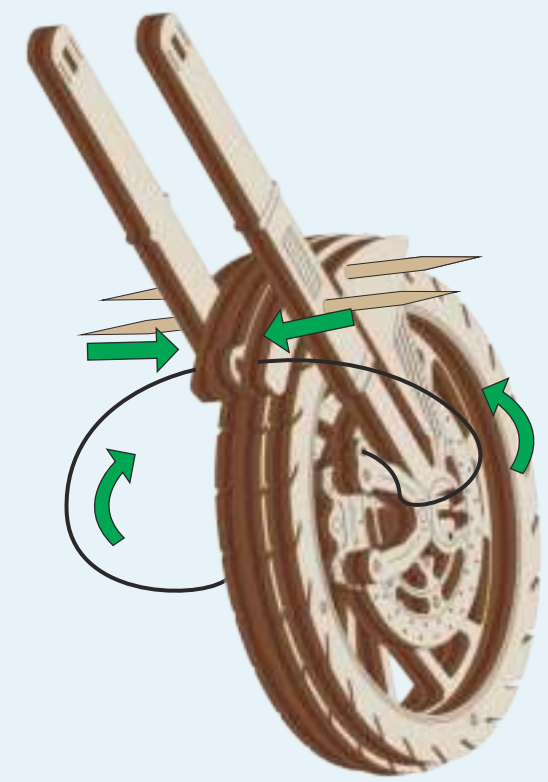
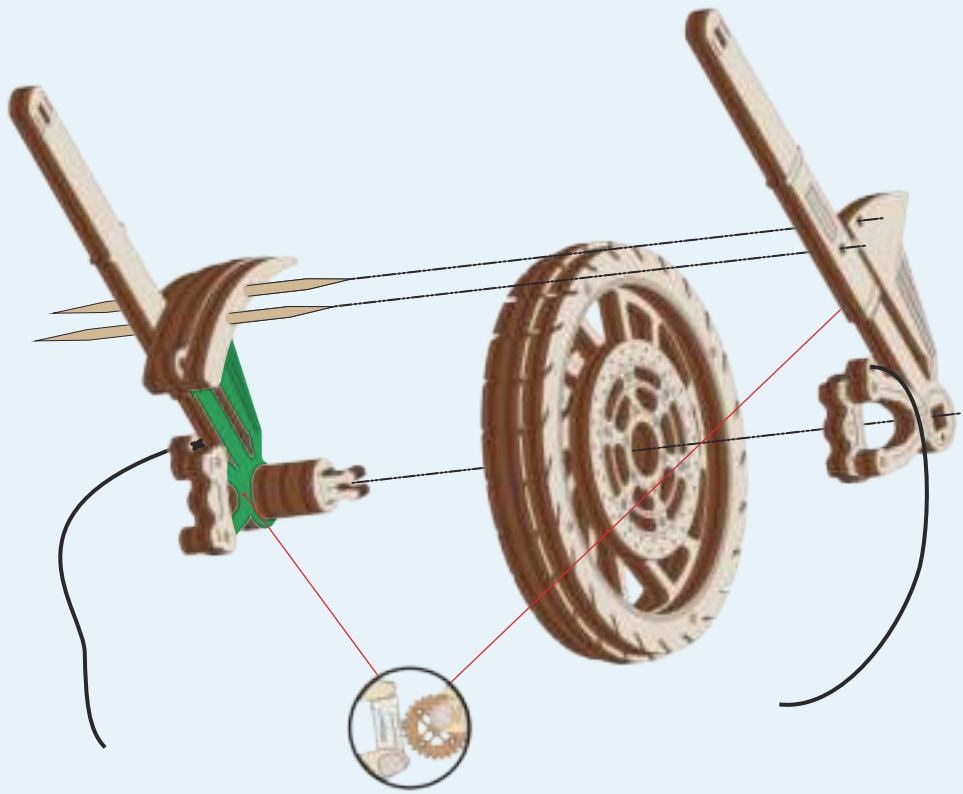

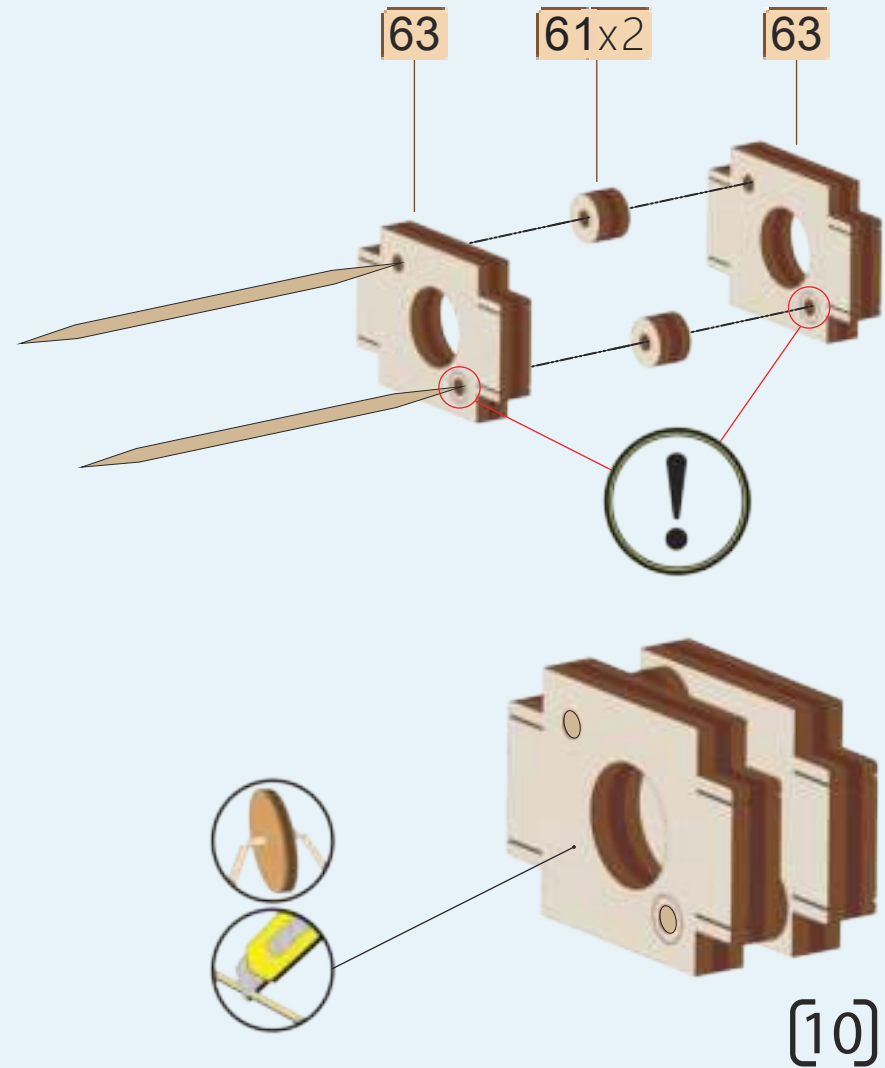
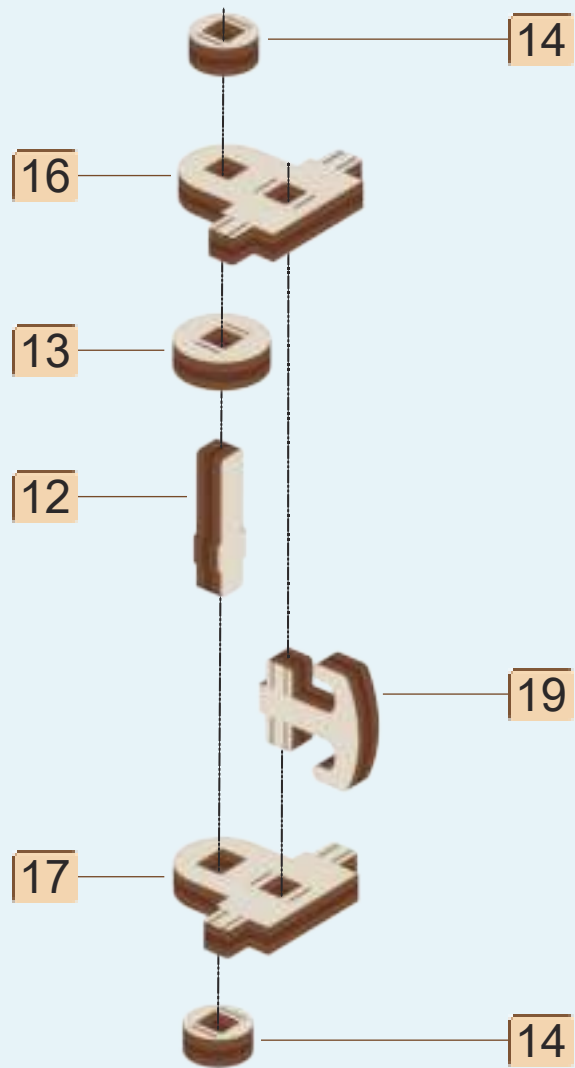

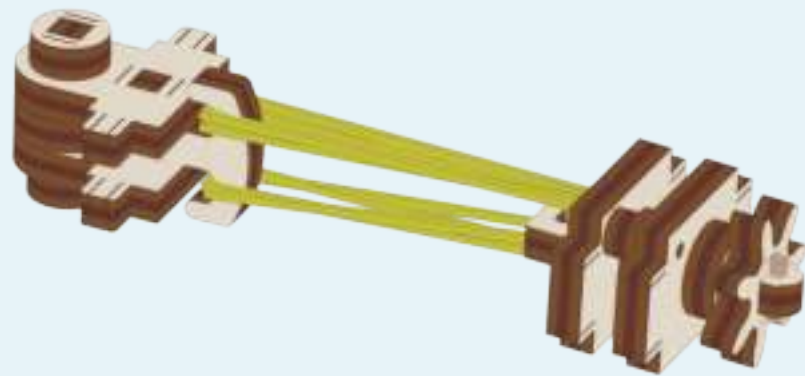
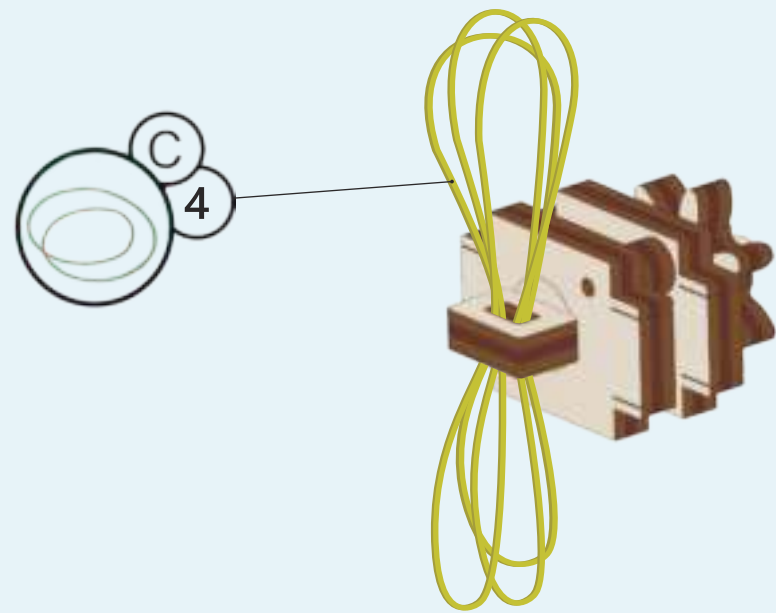
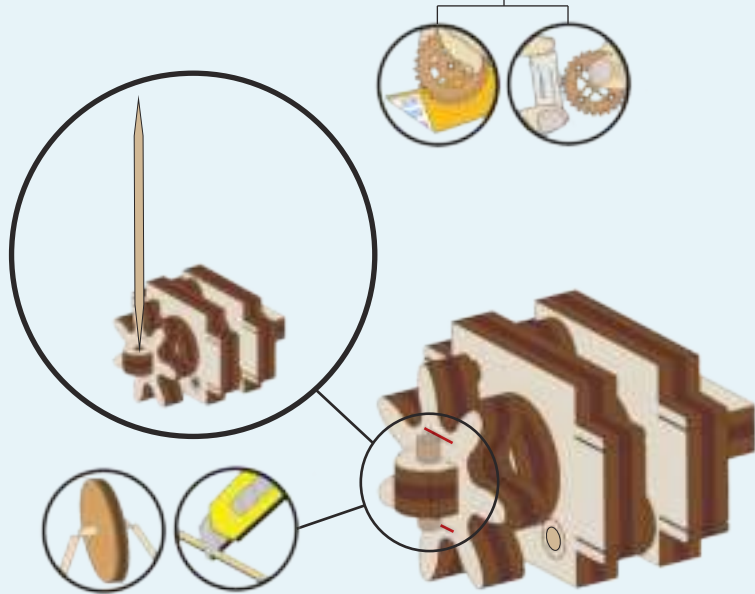
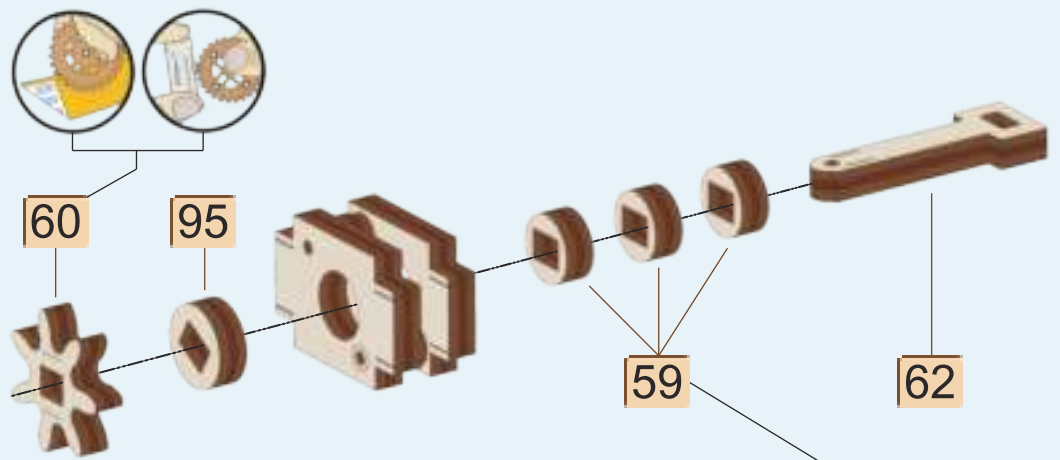

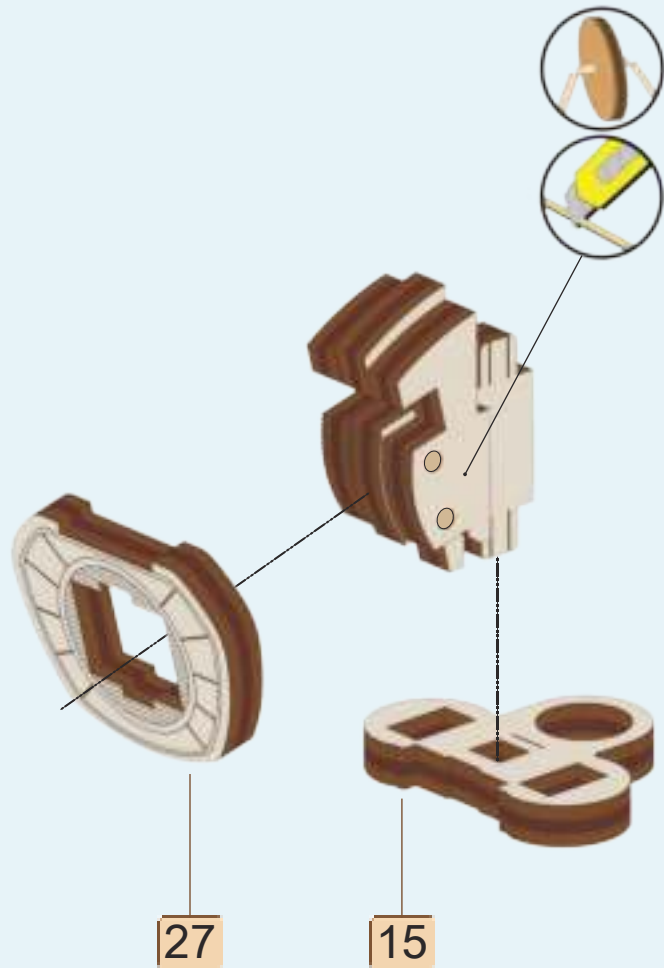
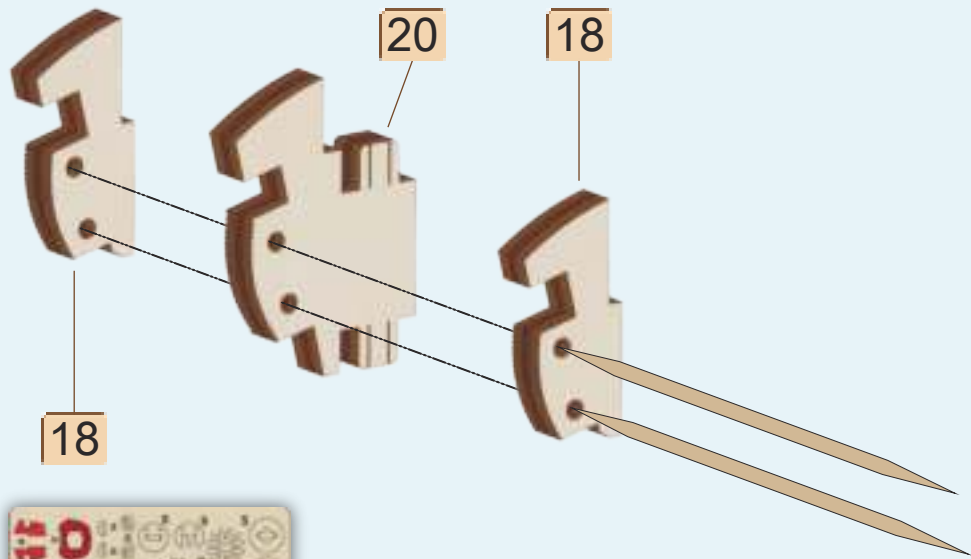

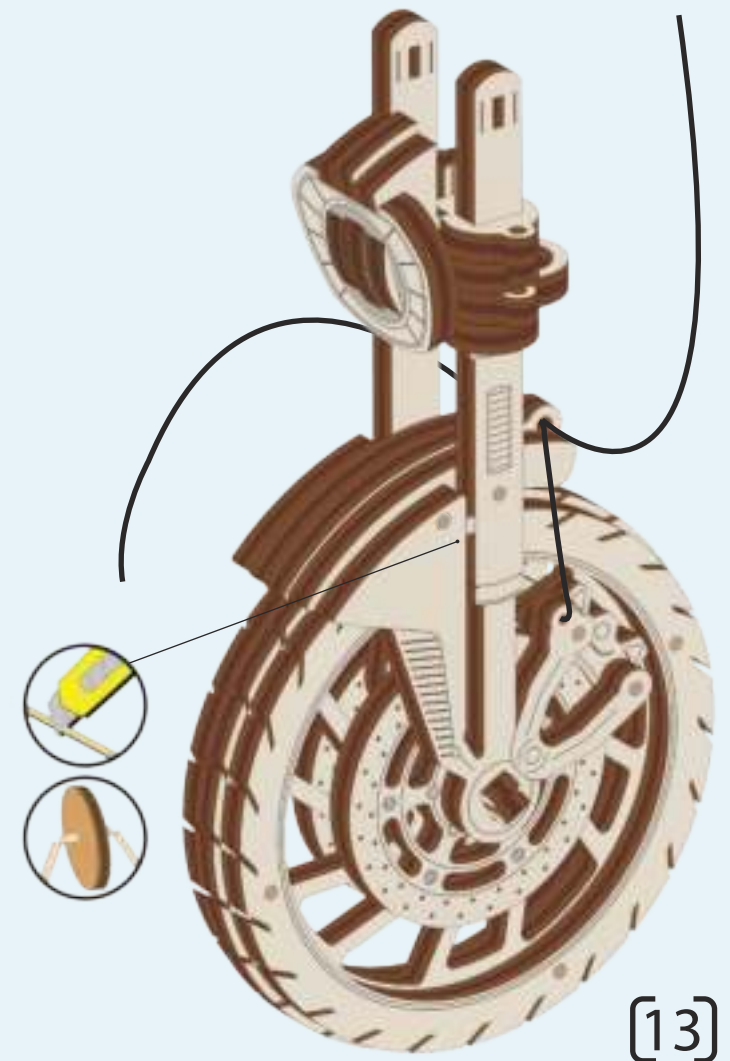
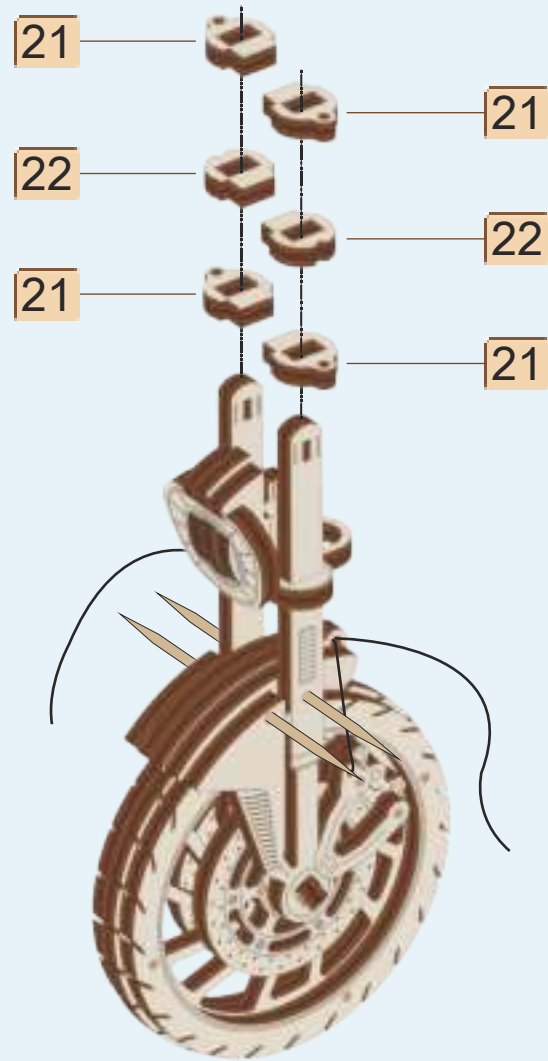
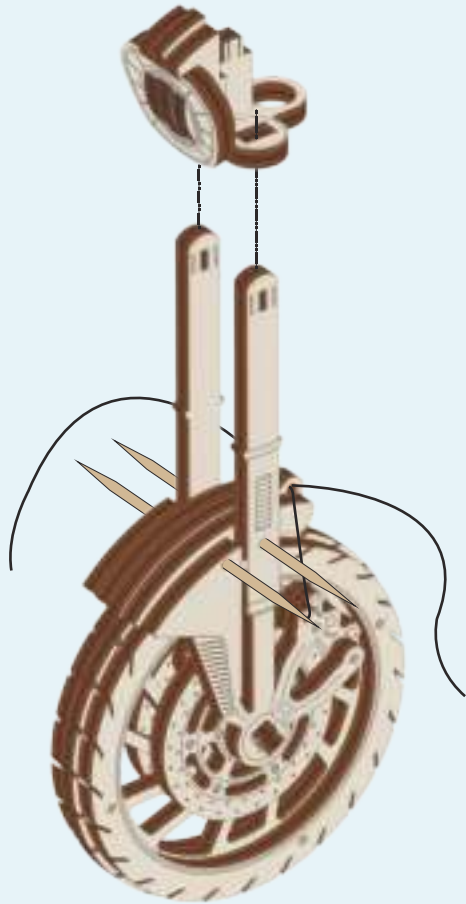

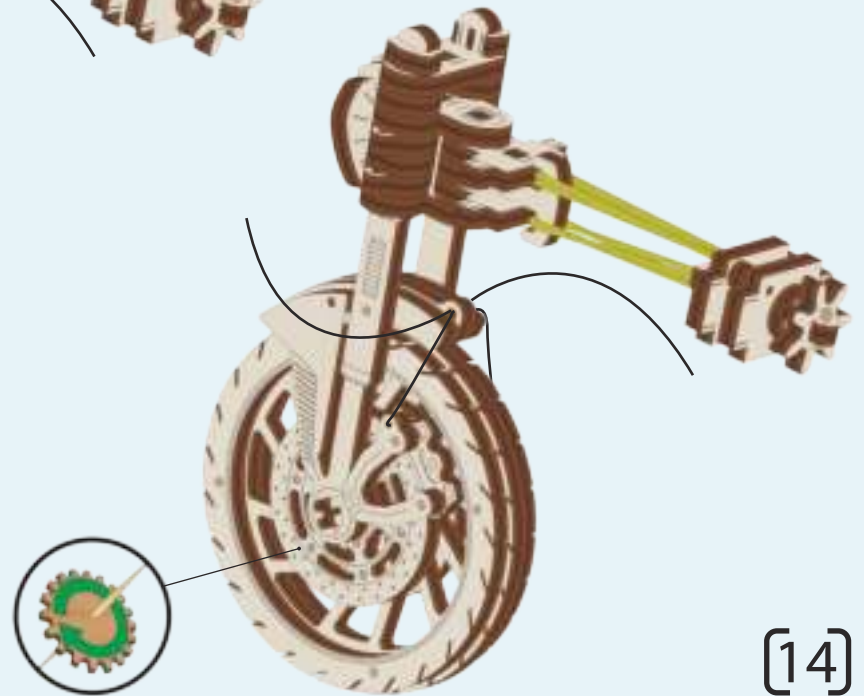
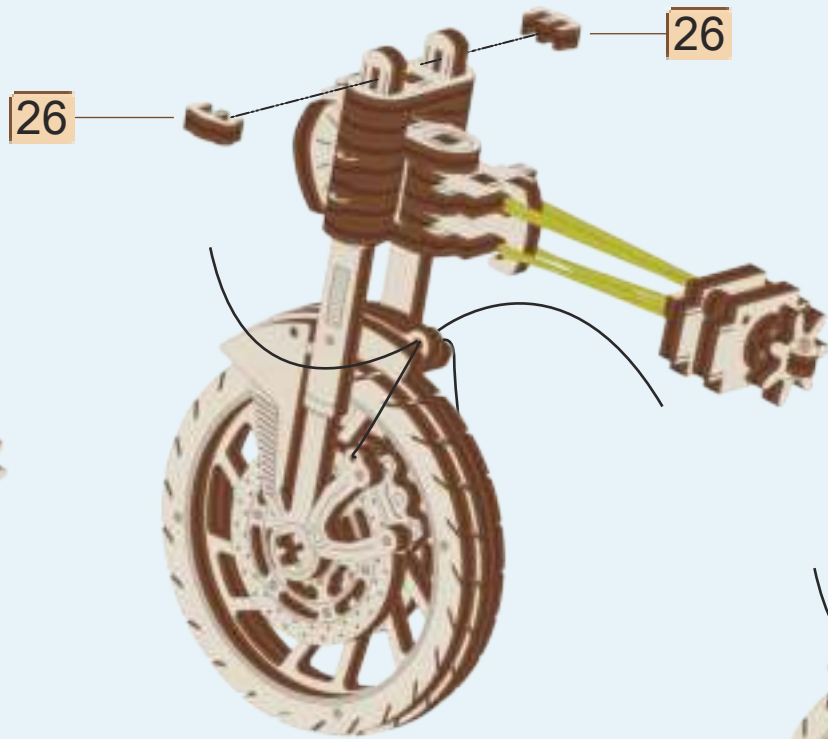
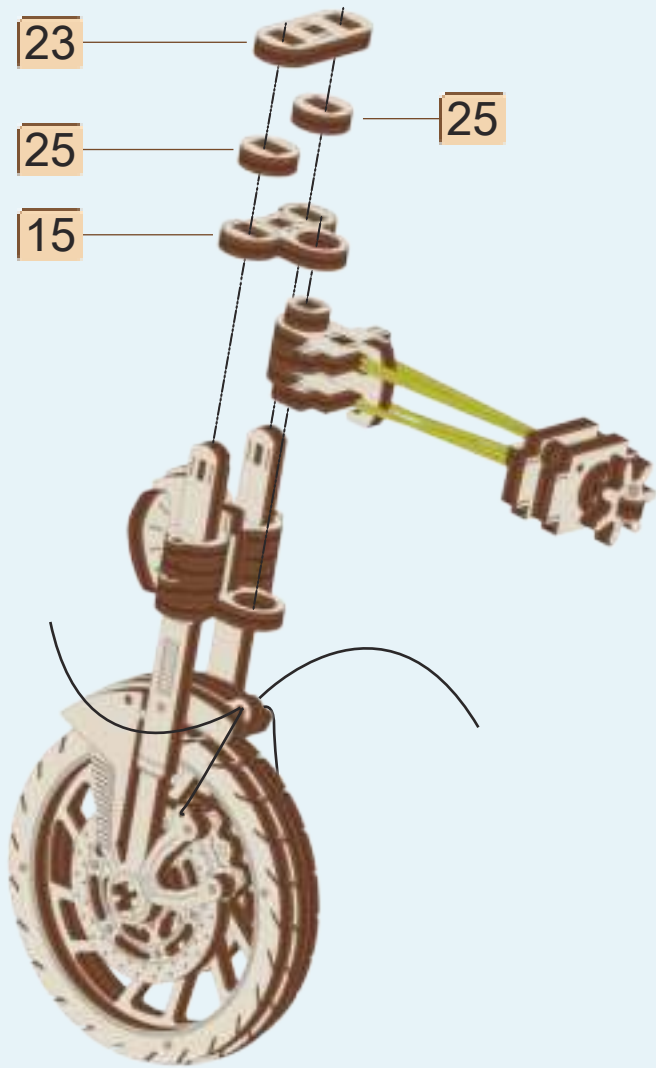

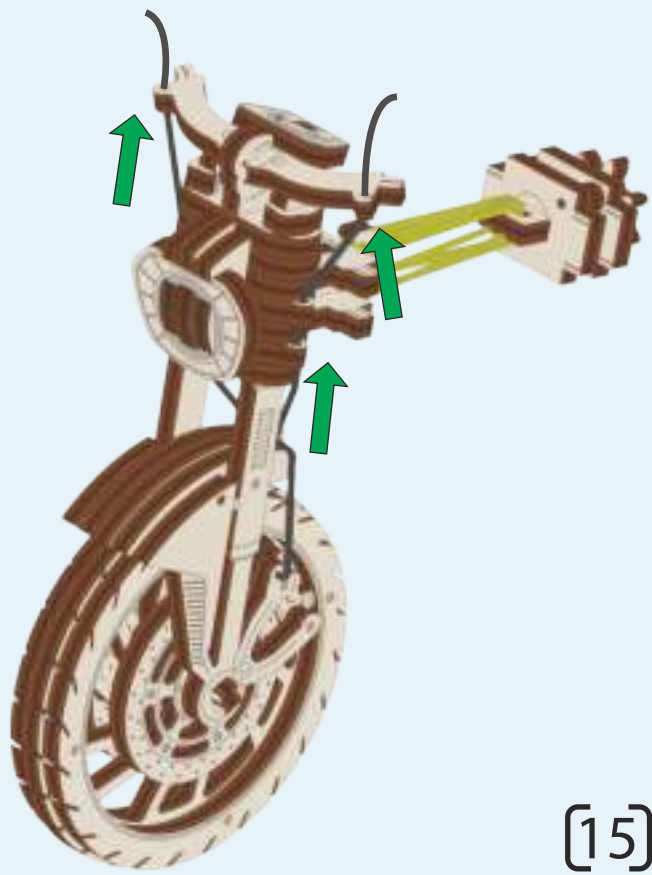
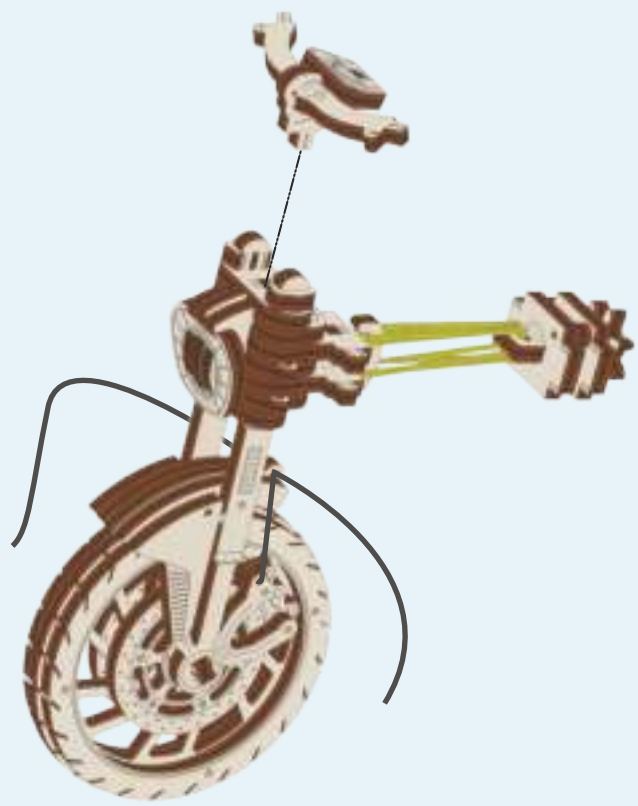
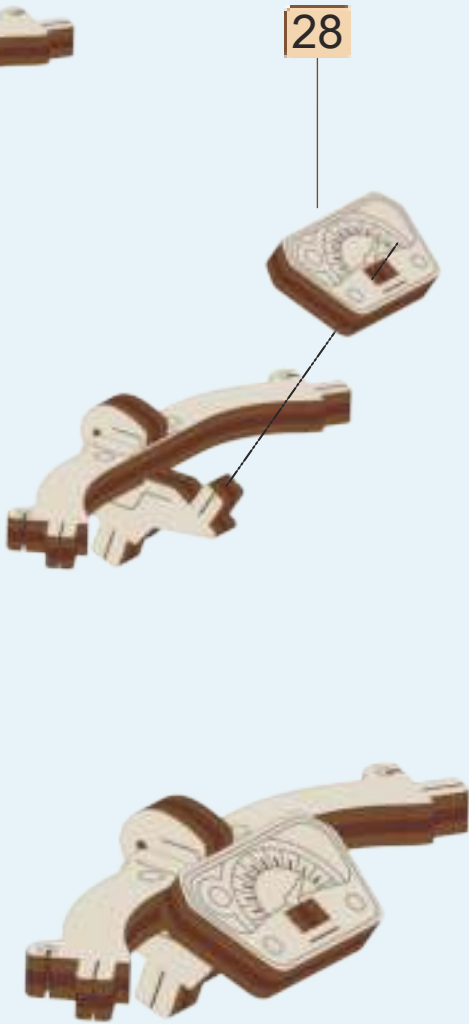
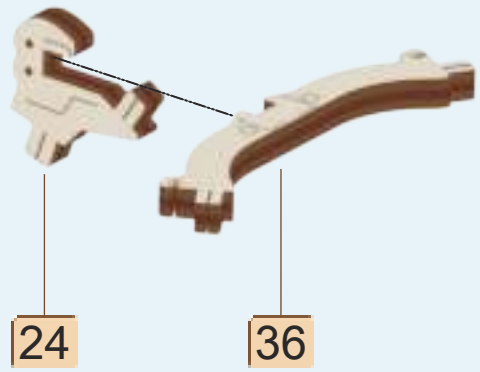

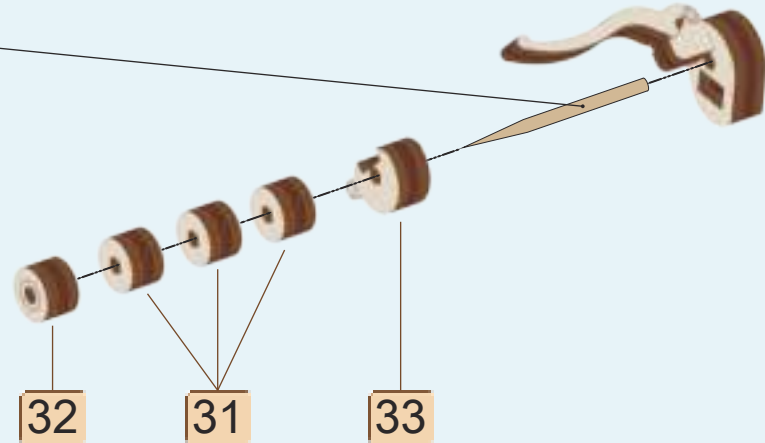
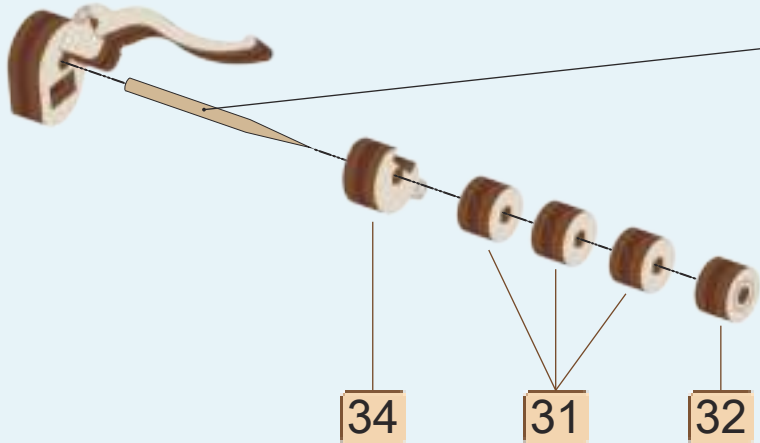
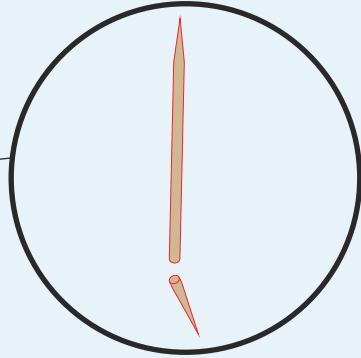

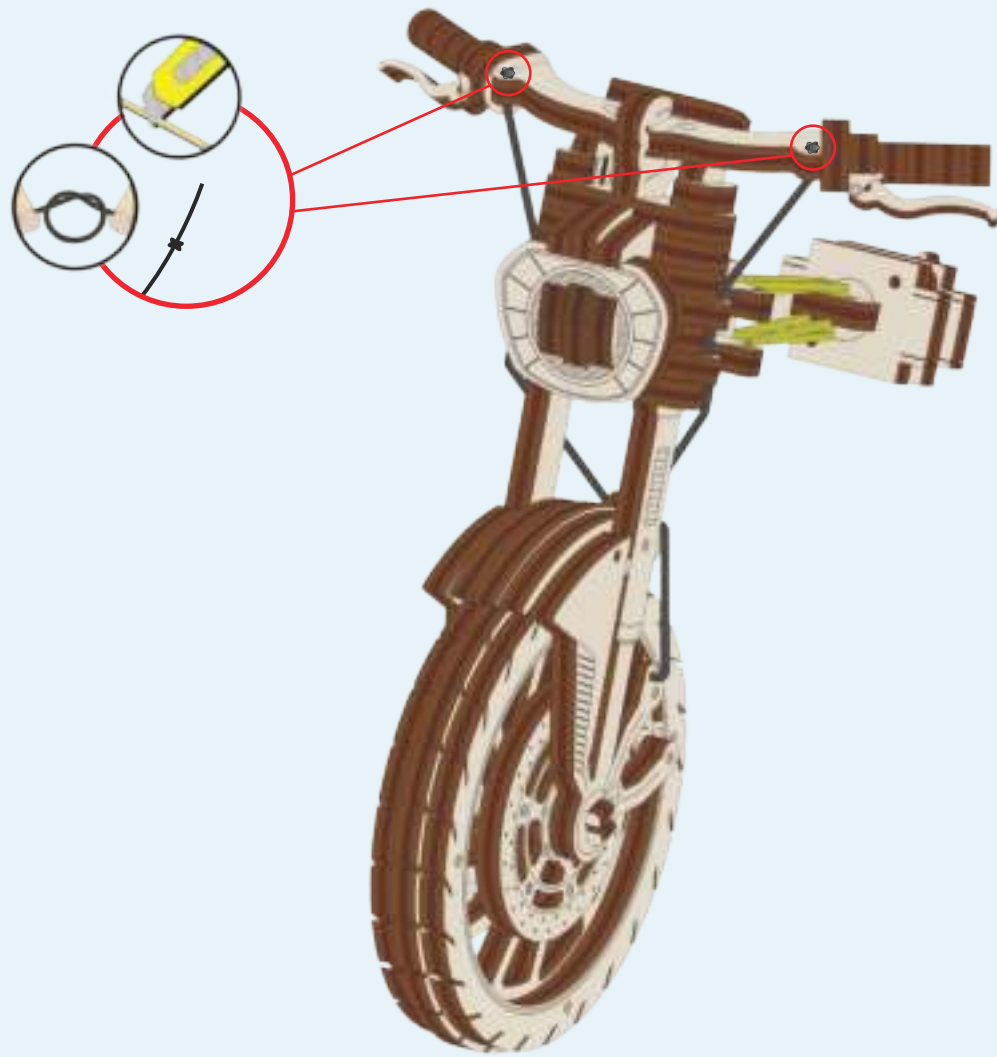

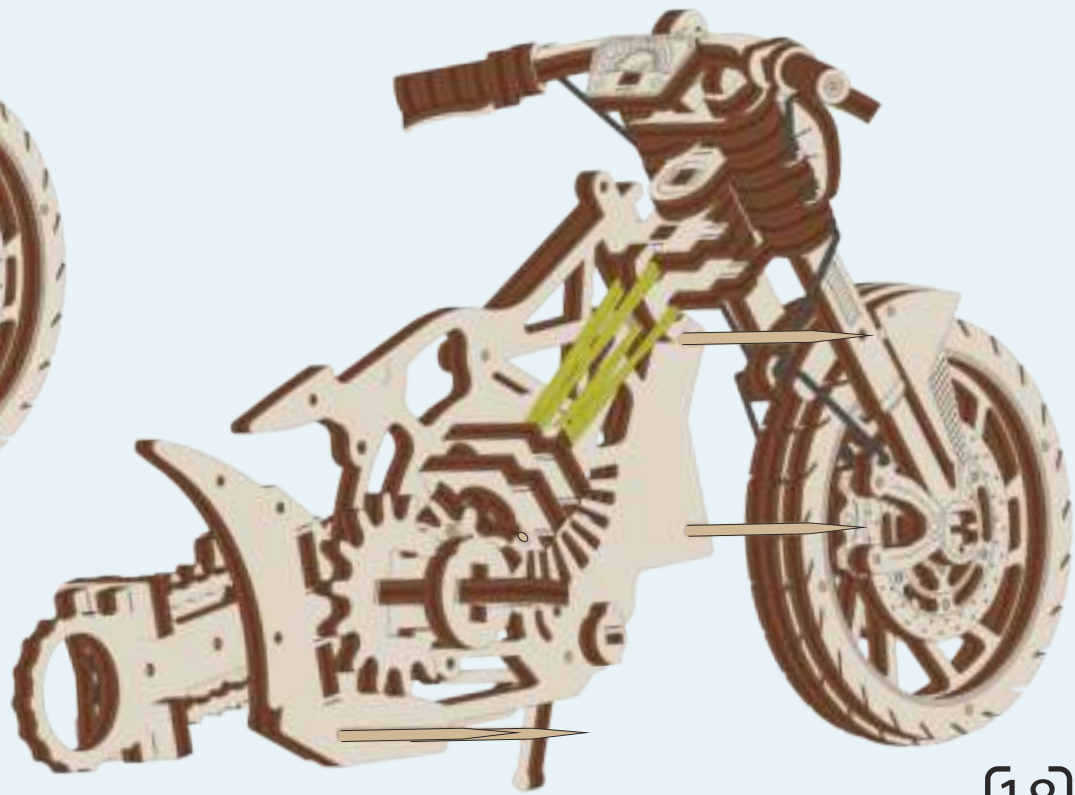
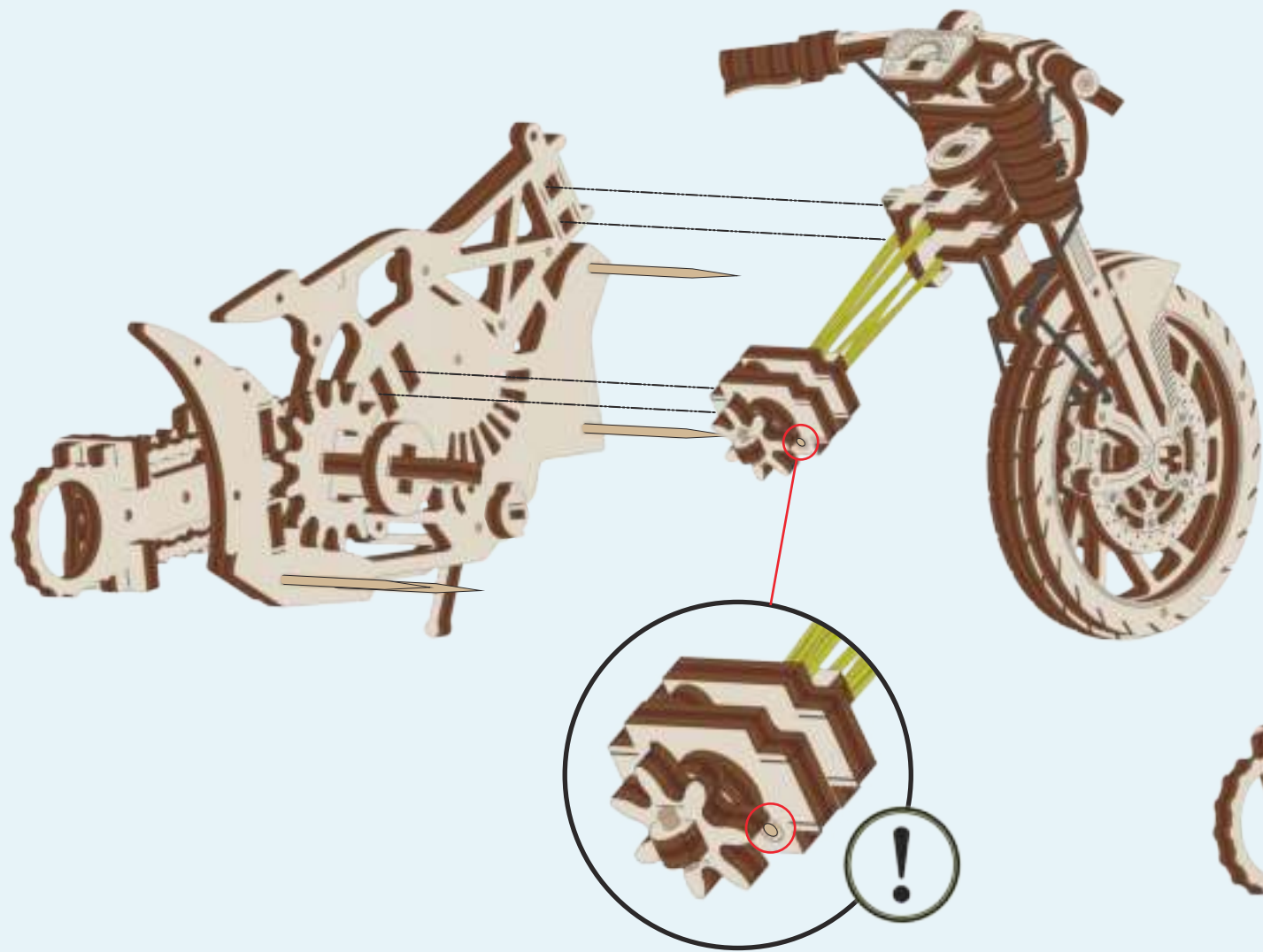

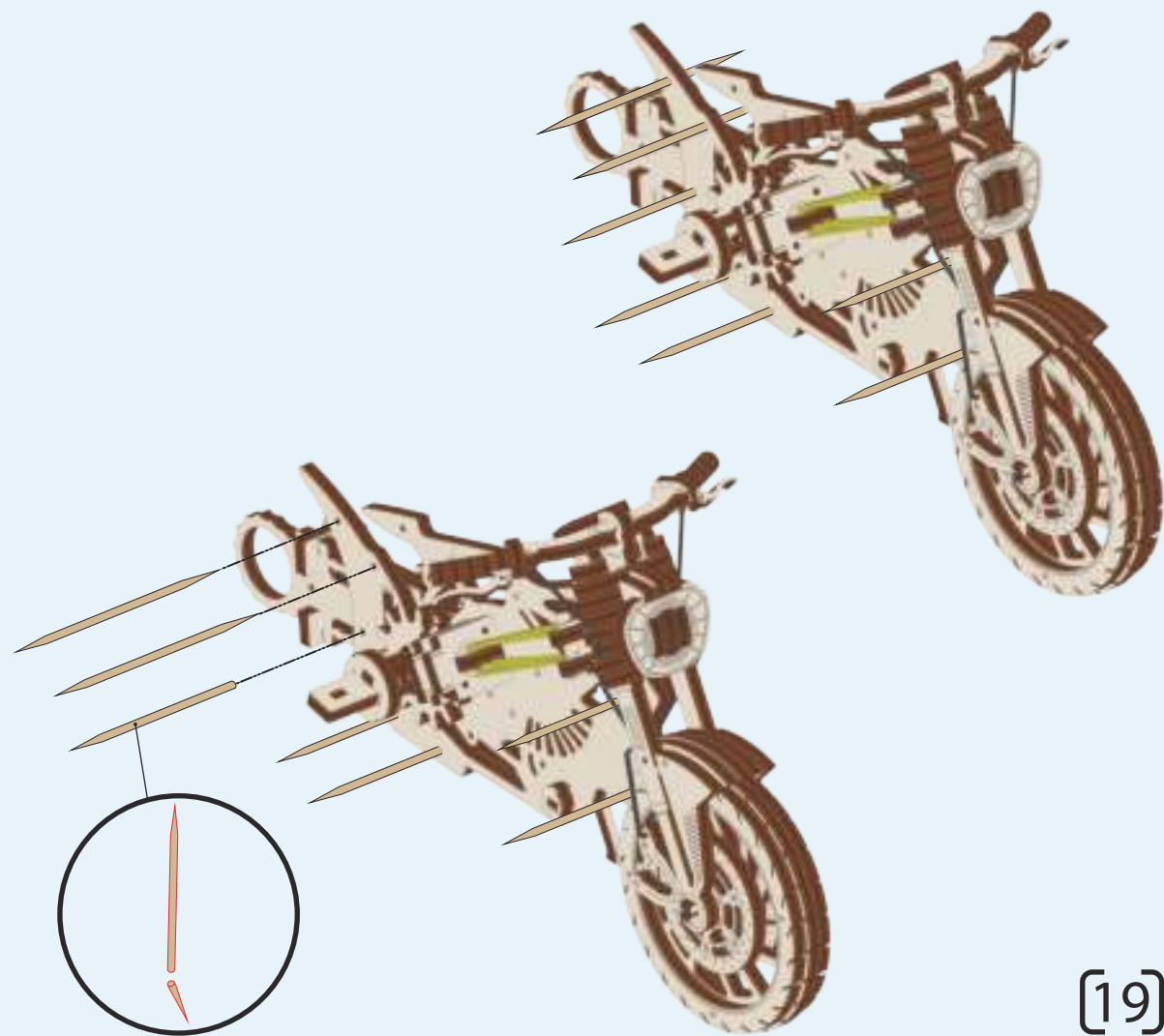
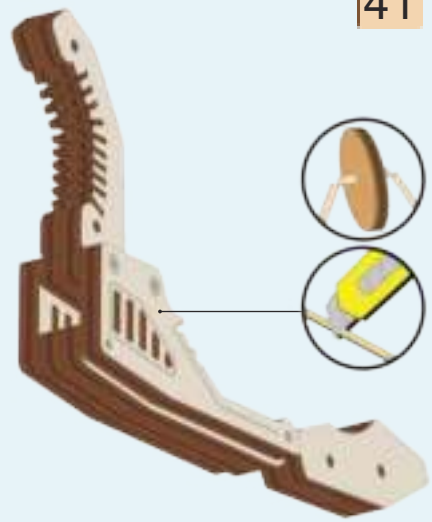
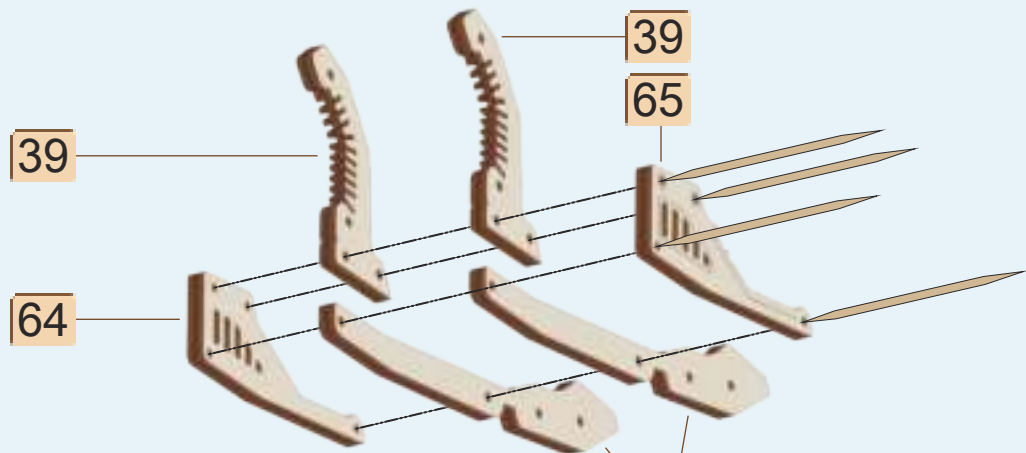

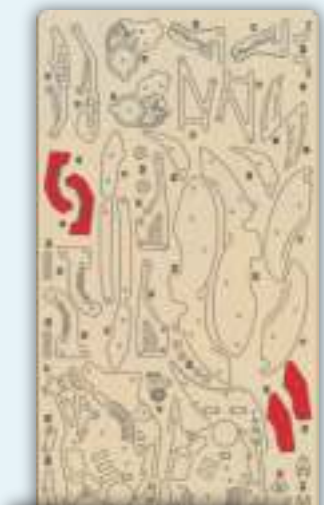

2



3

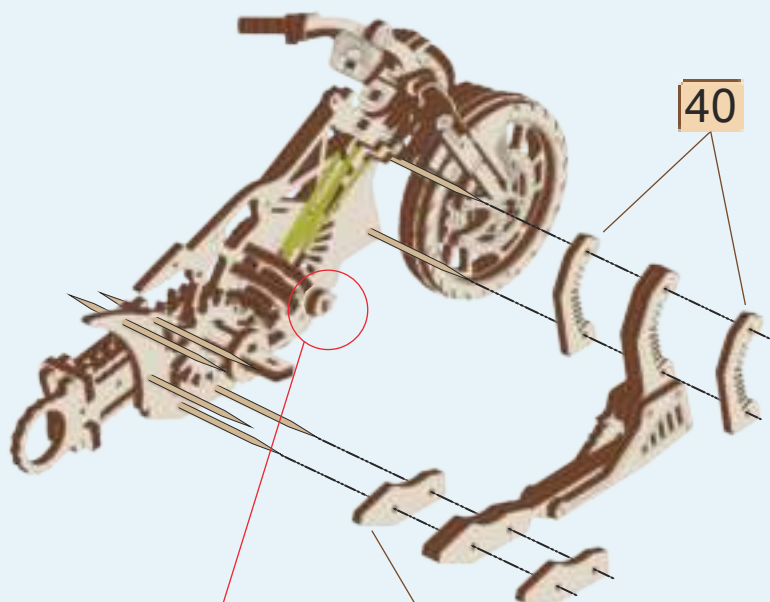

40

68

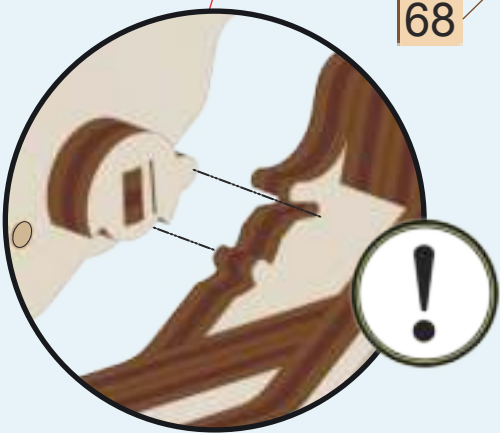

73

74

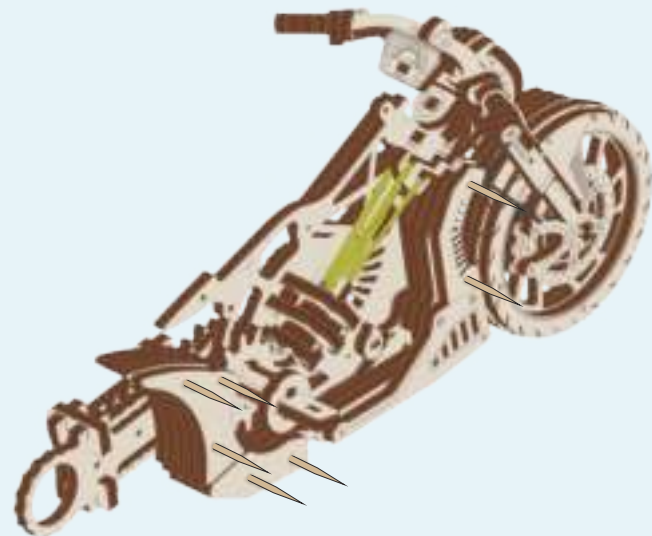

[20]

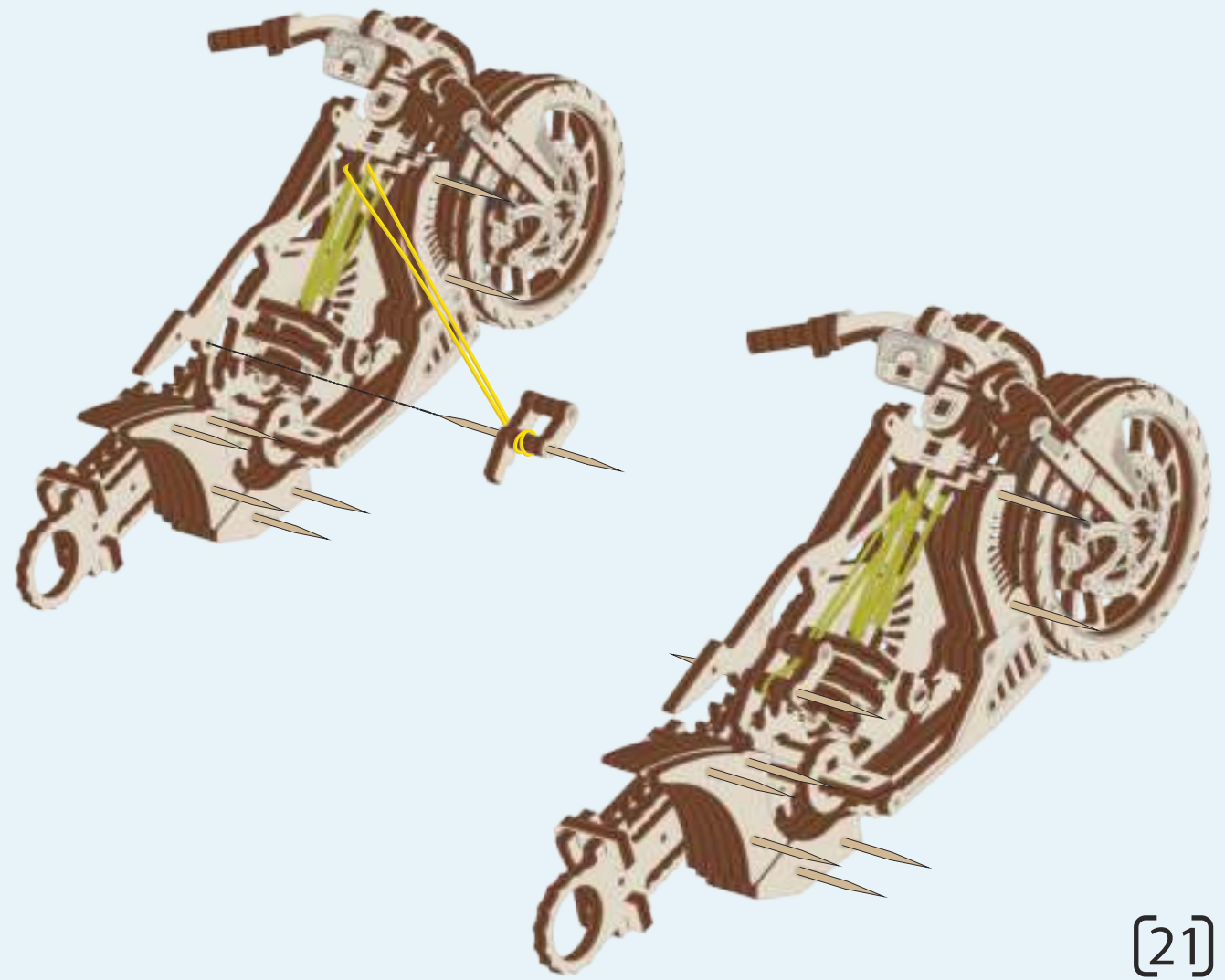
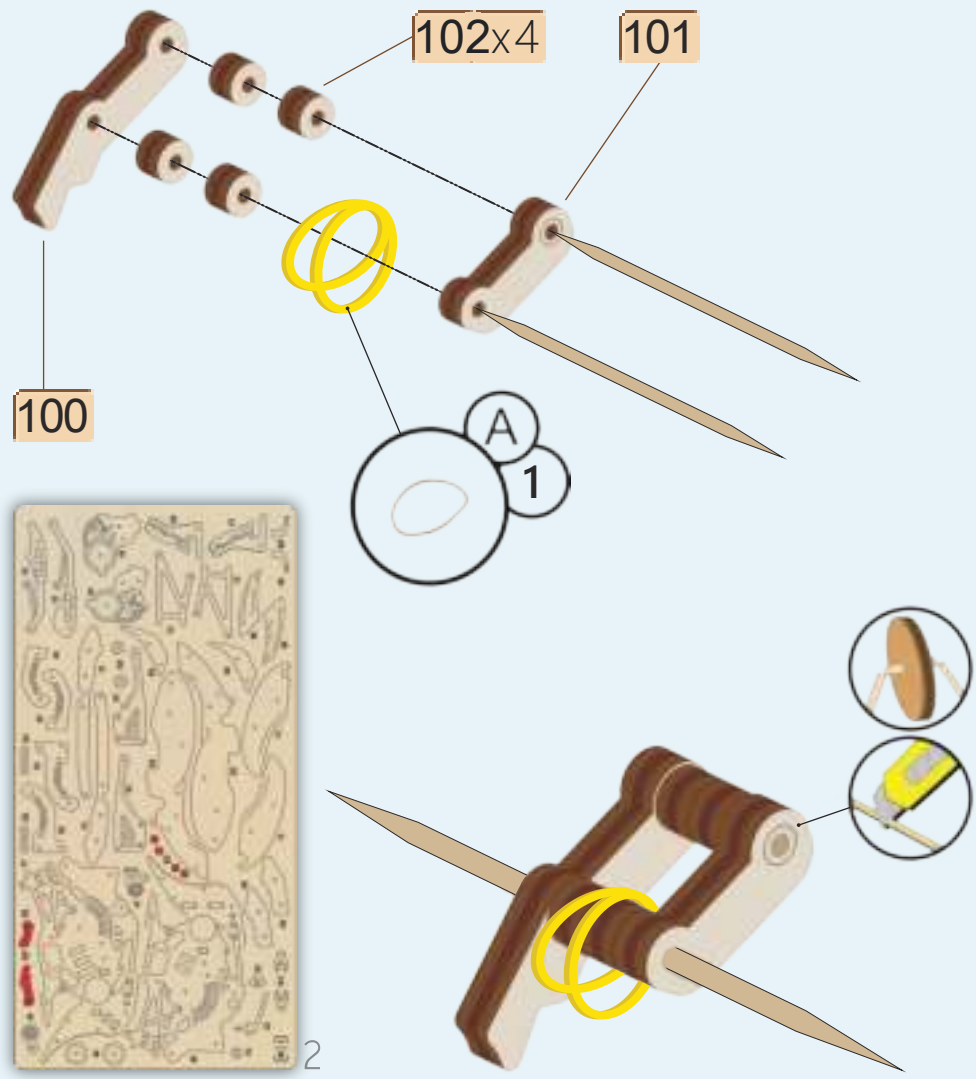



2

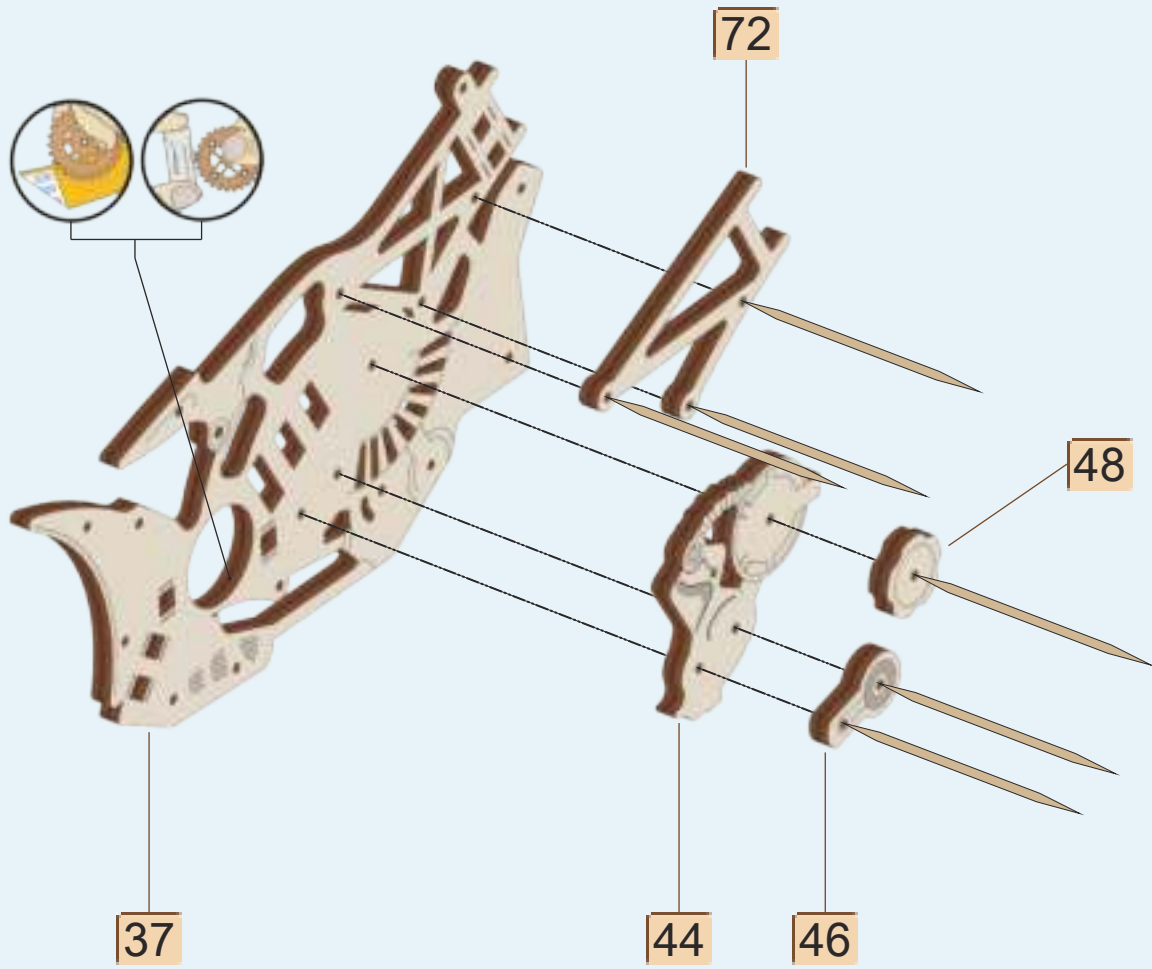

37

44

46

72

48

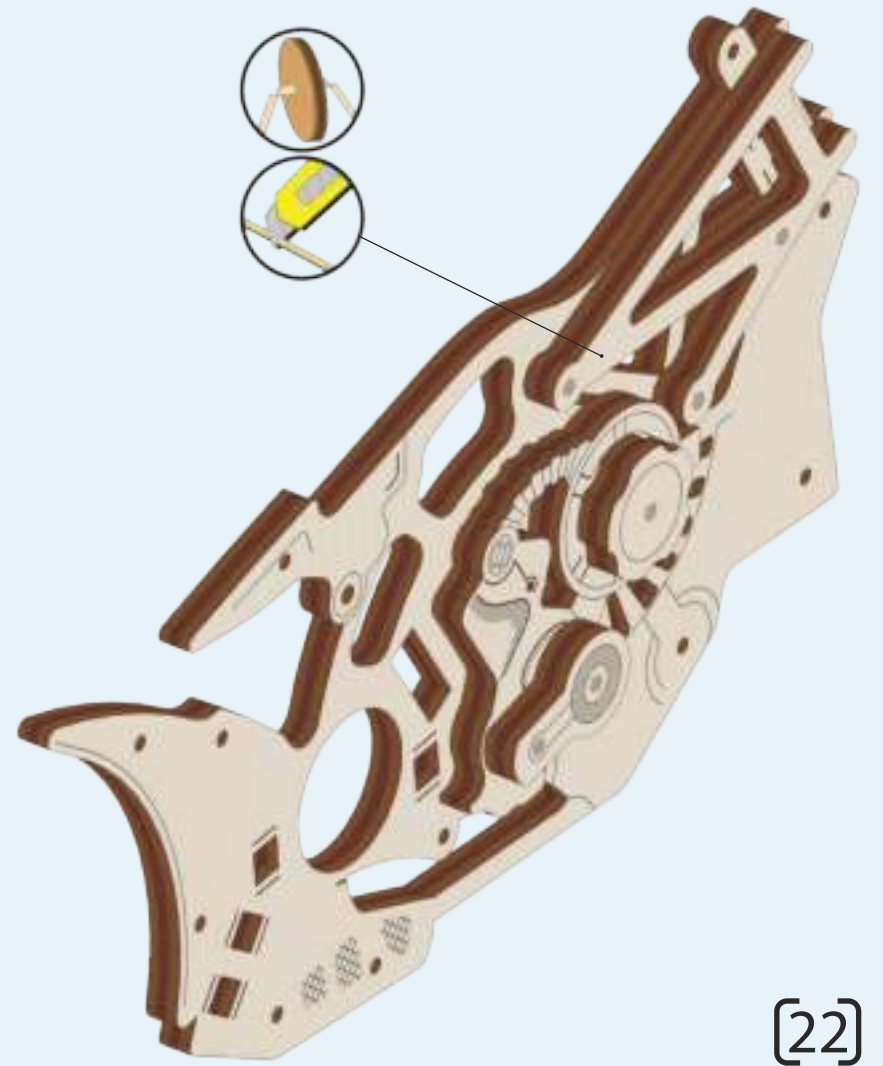

[22]

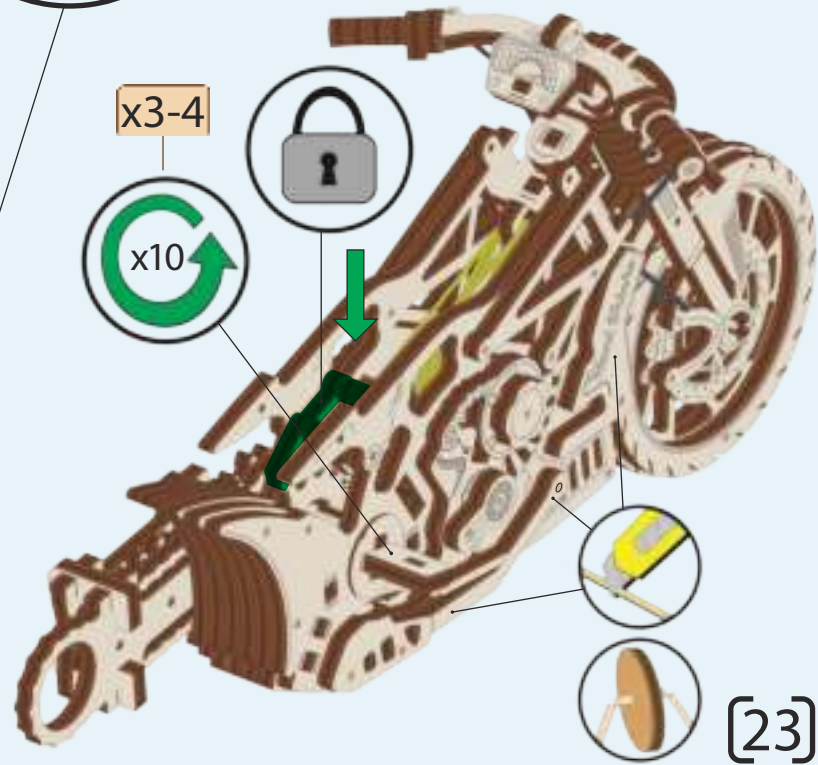
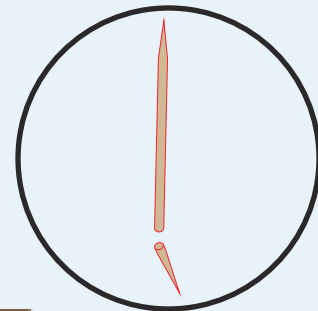
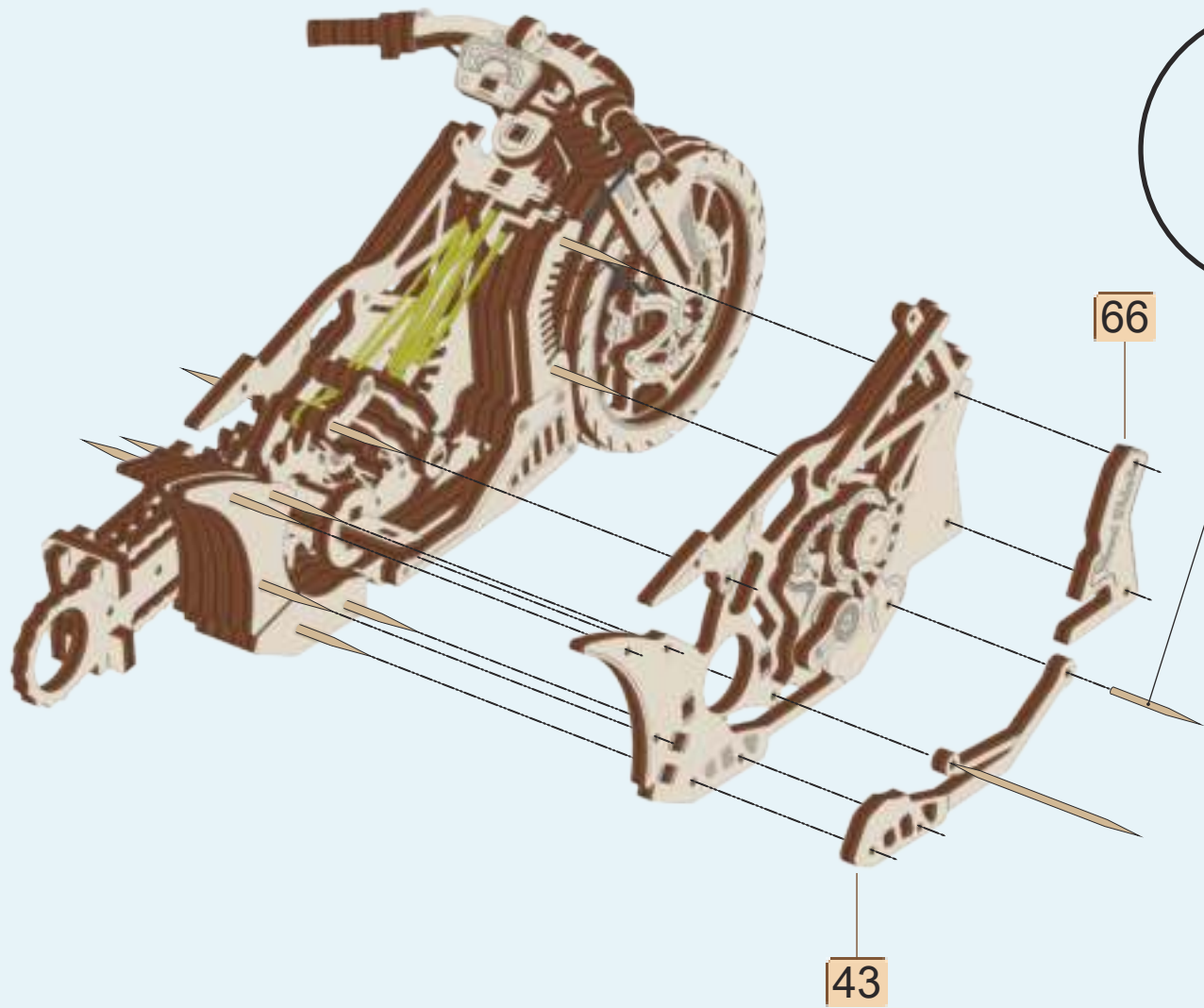

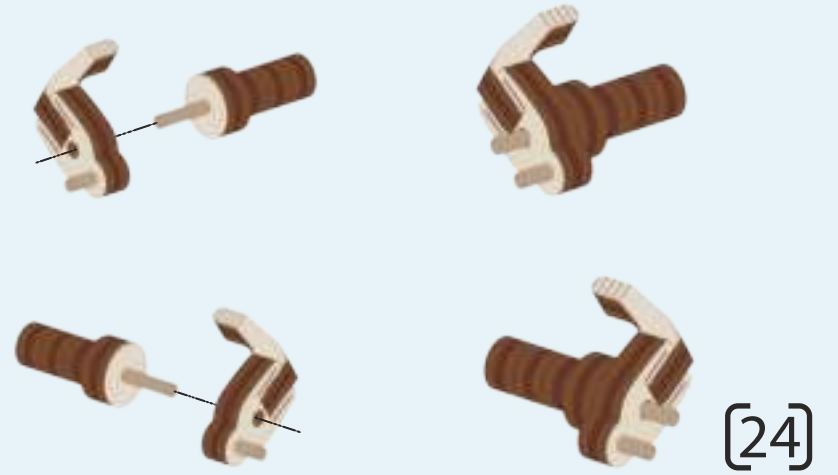
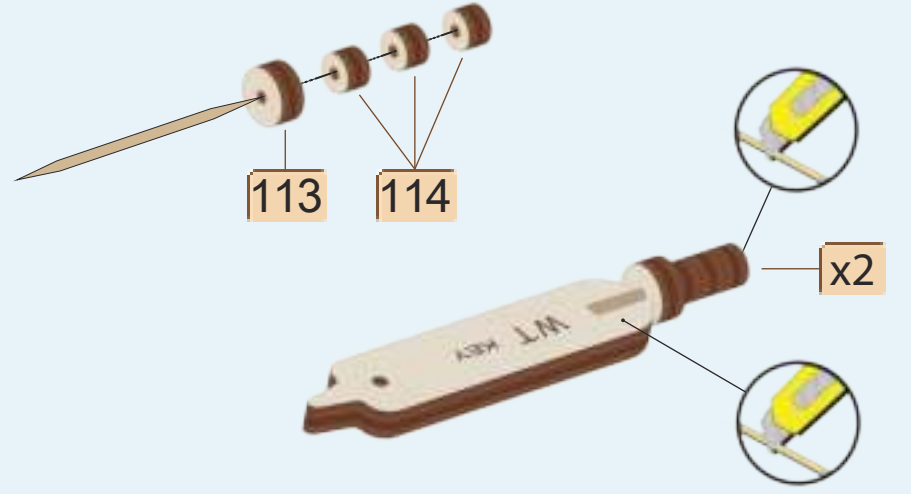
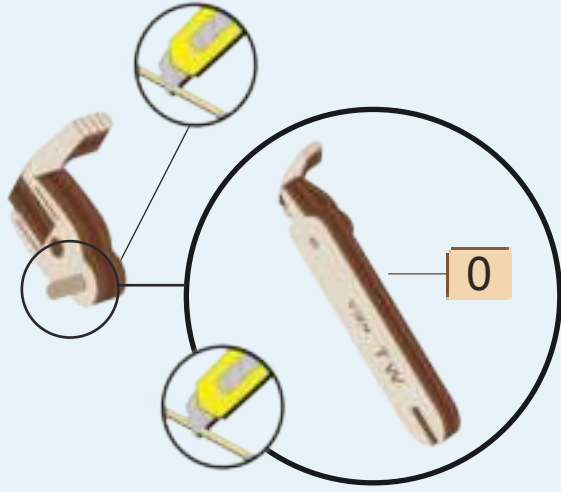
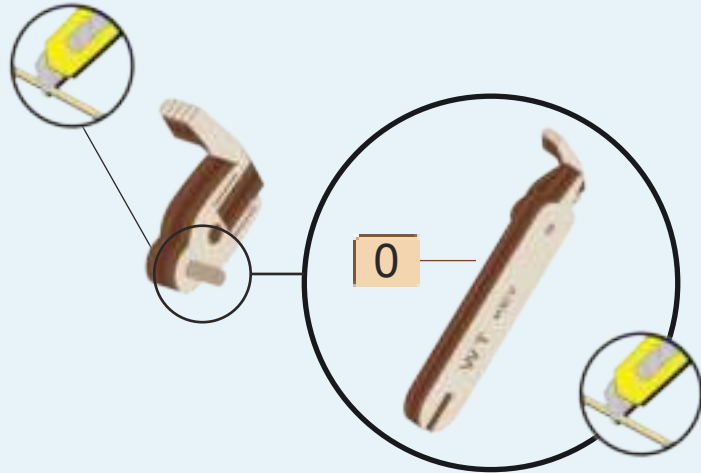
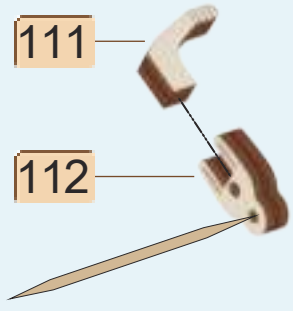
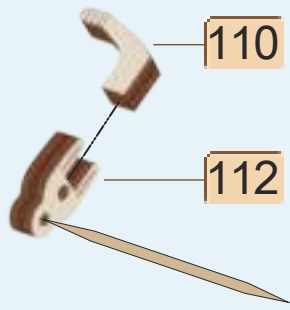

[24]

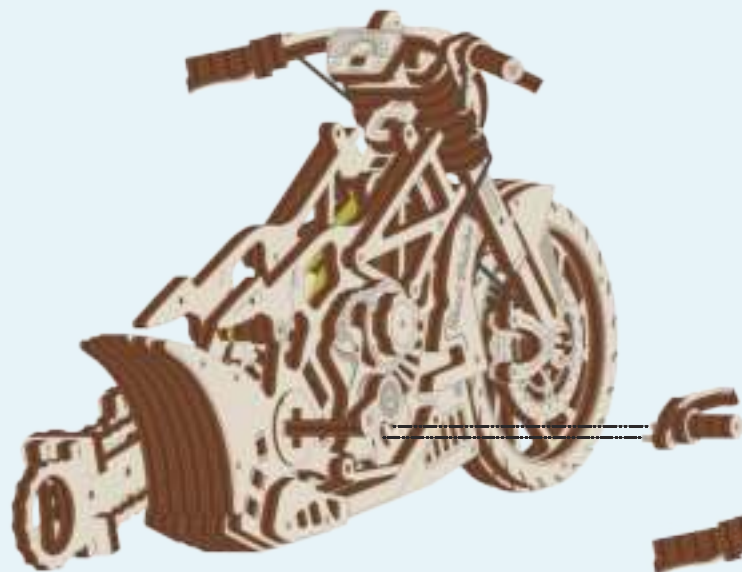



2



3

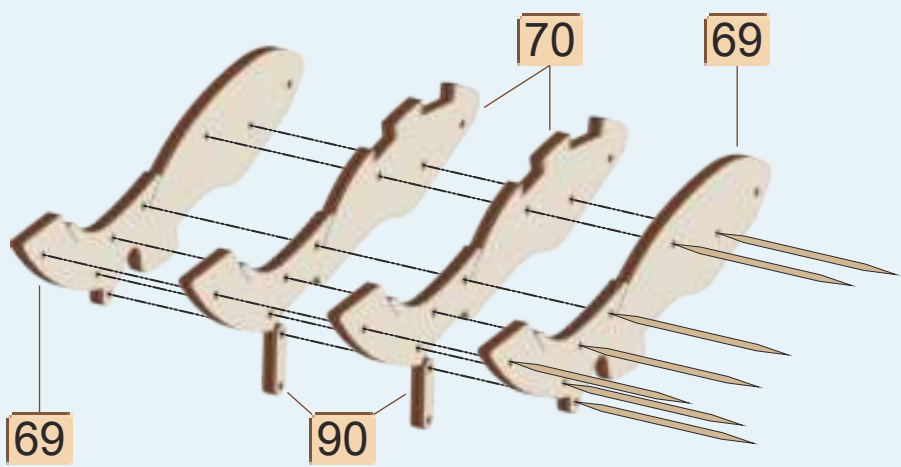

69

90

70

69

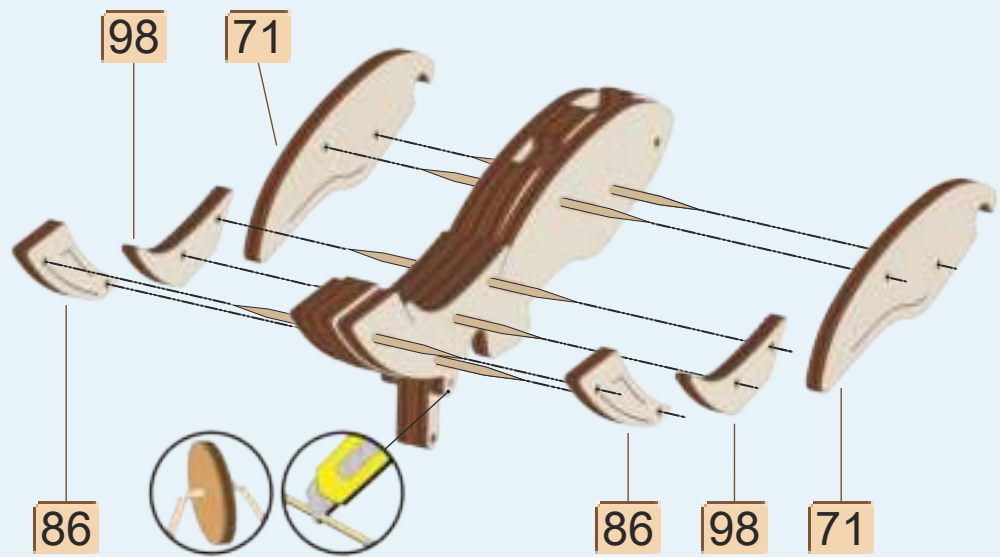

86

98

71

86

98

71

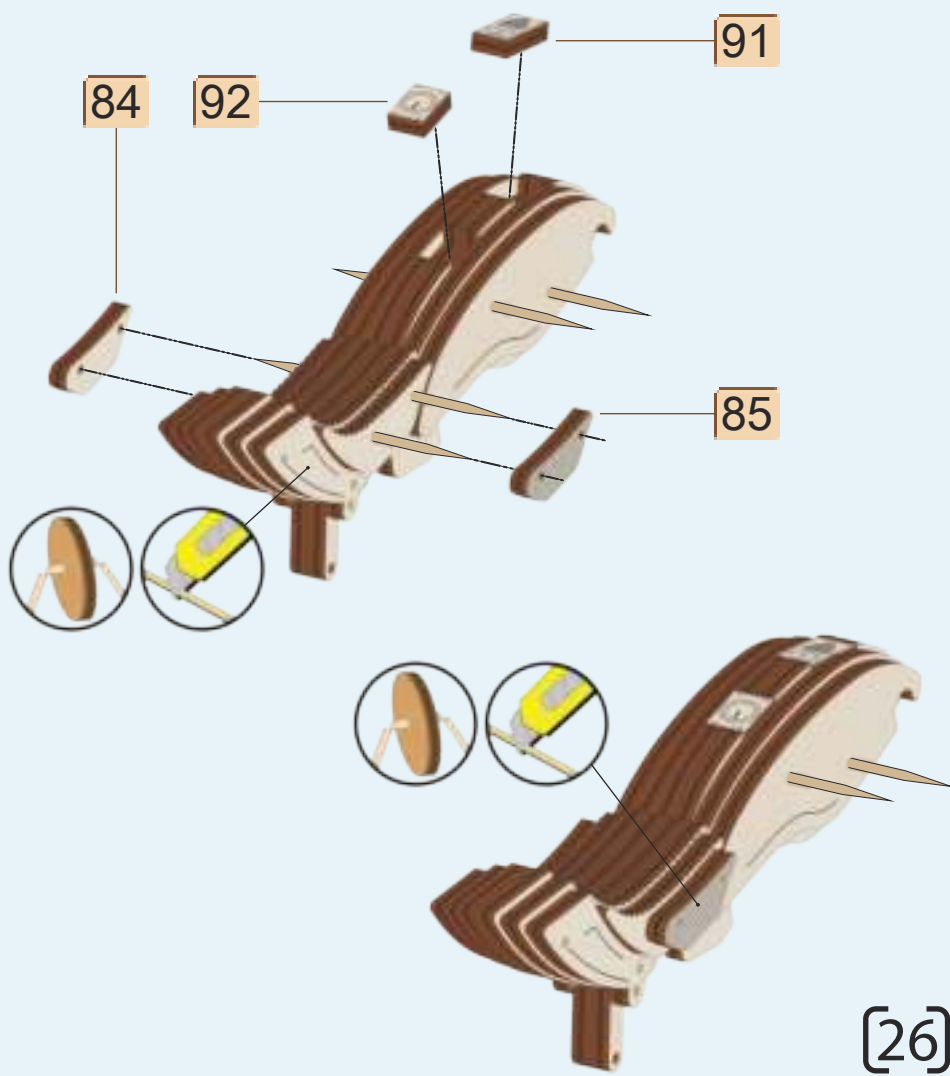

84

92

91

85

[26]

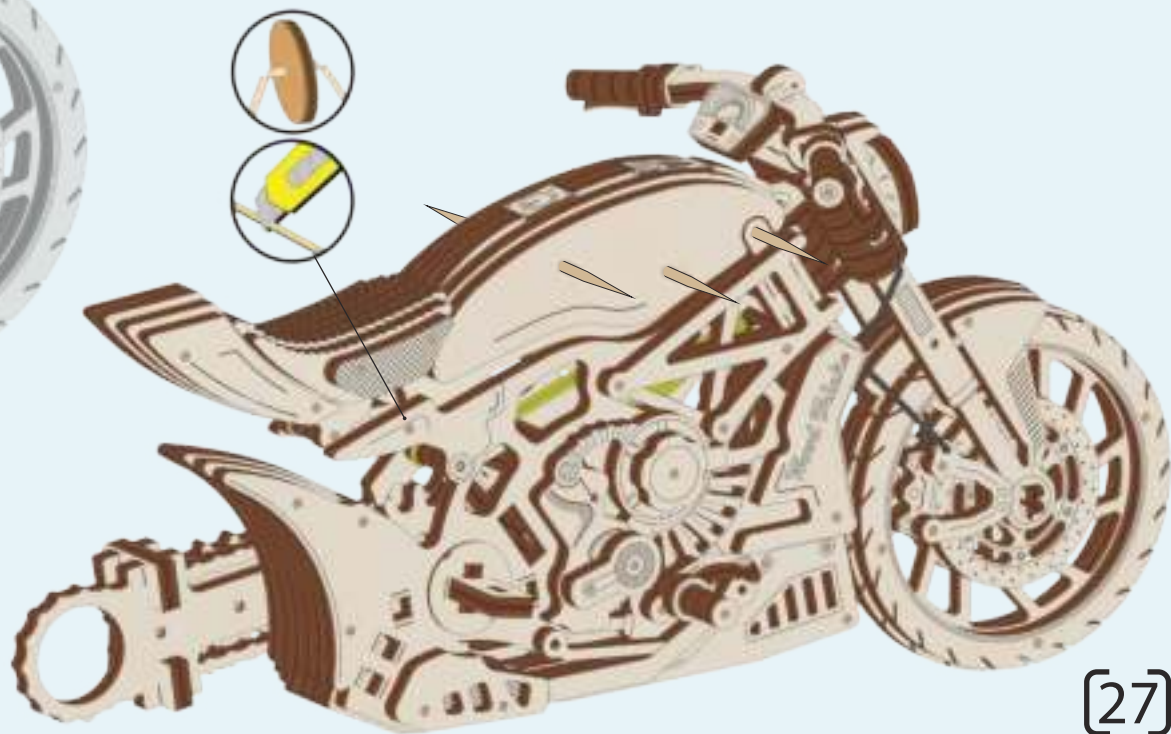
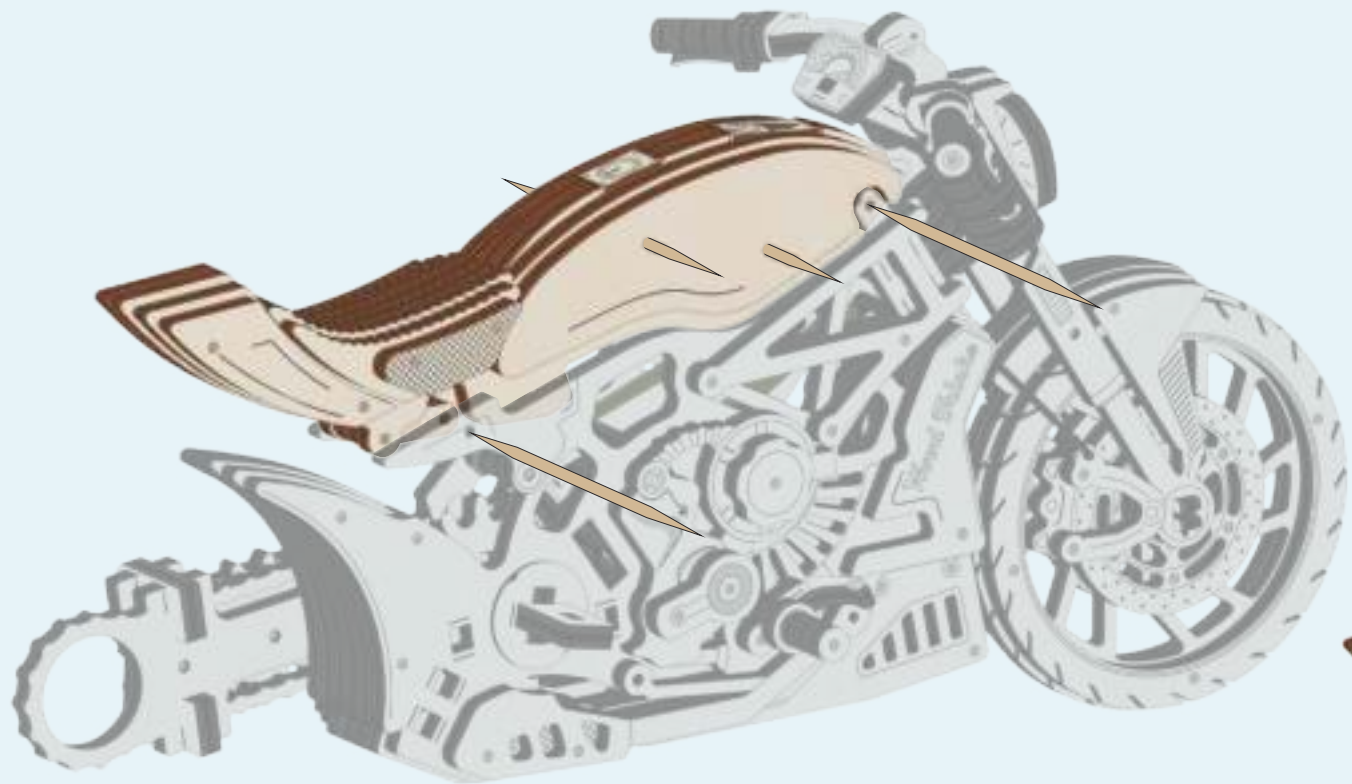

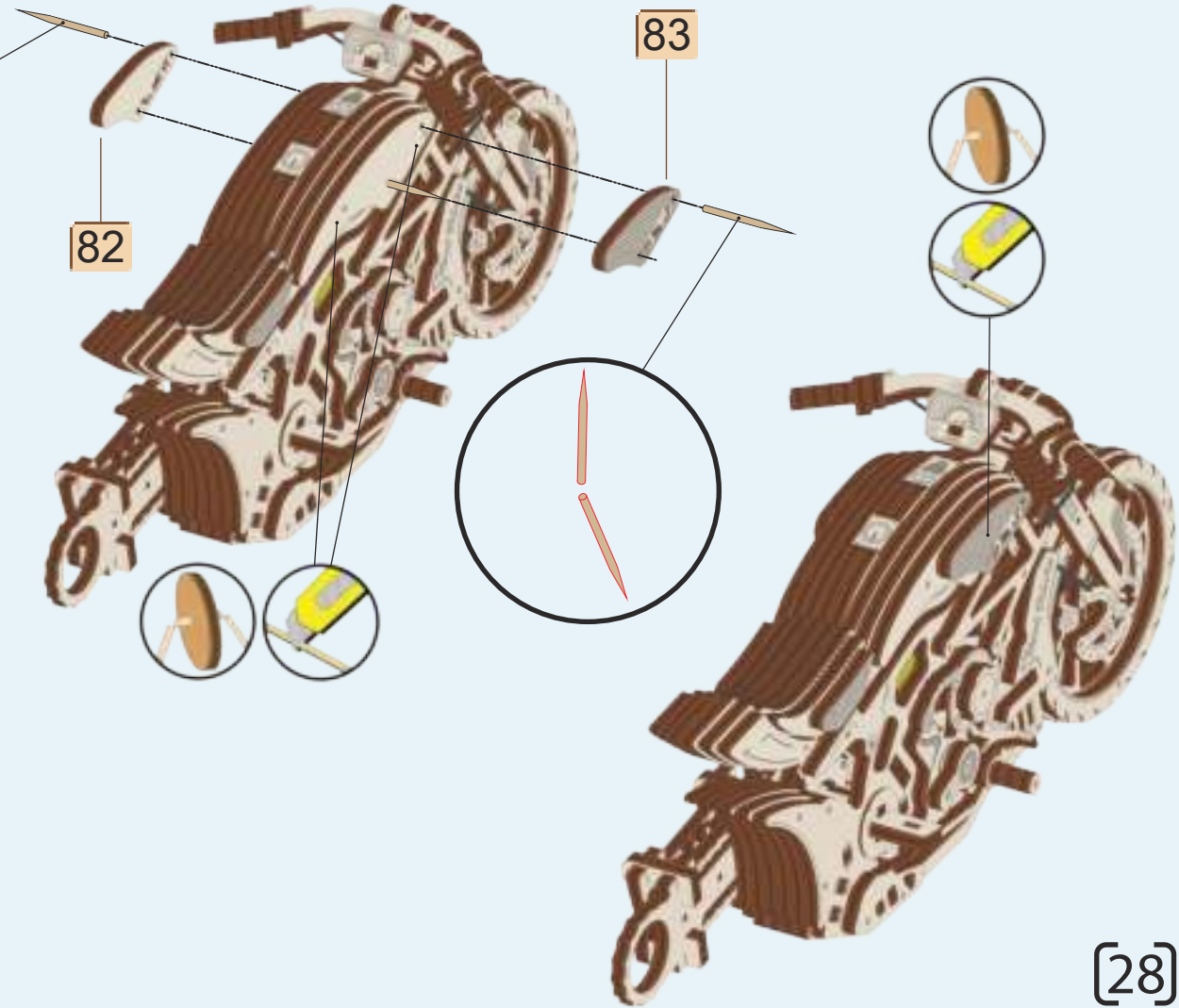
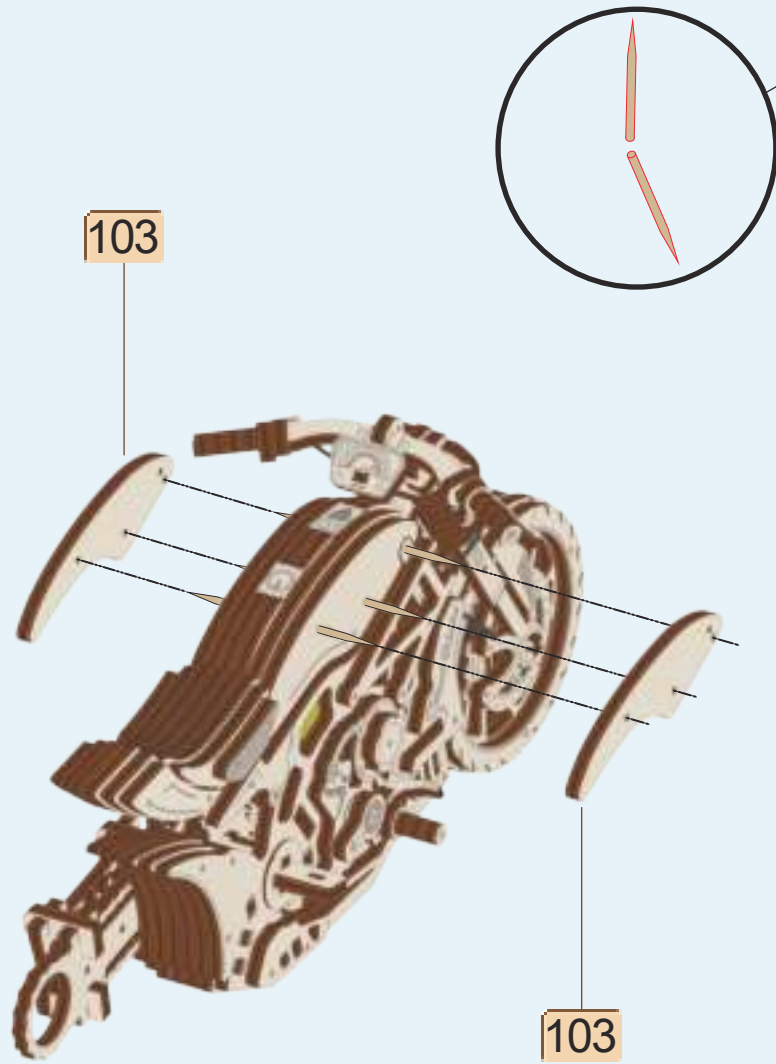

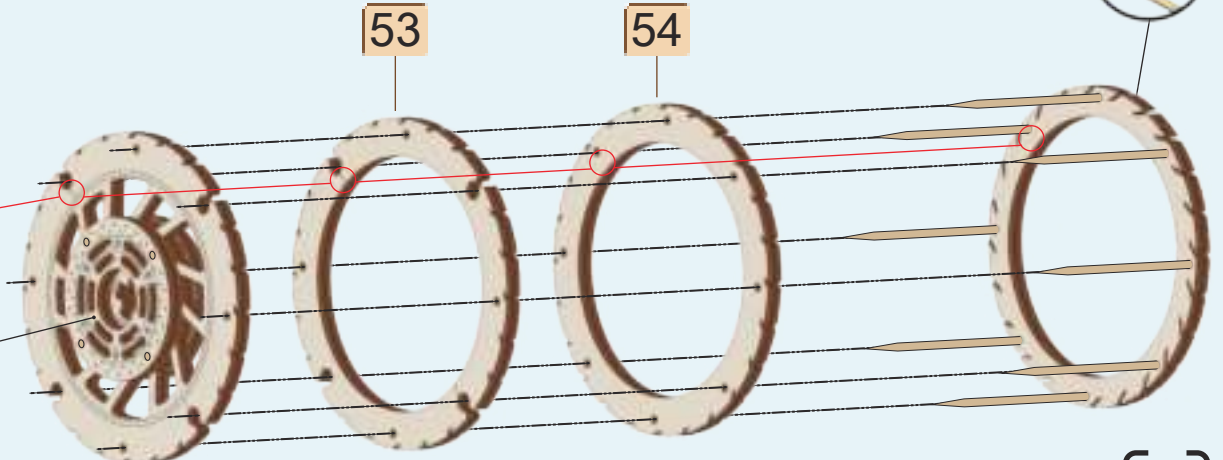
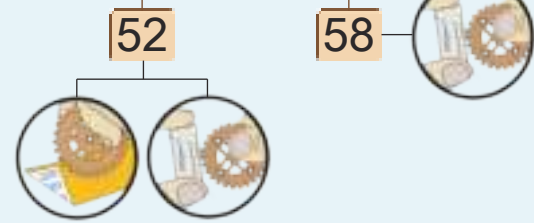
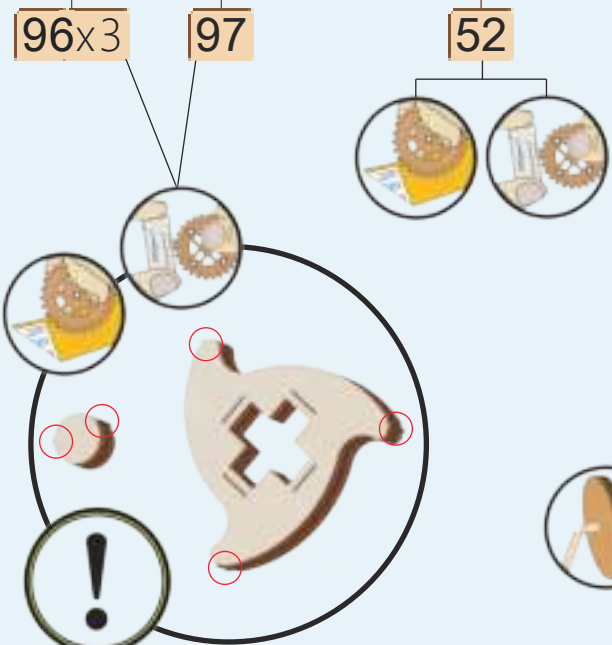
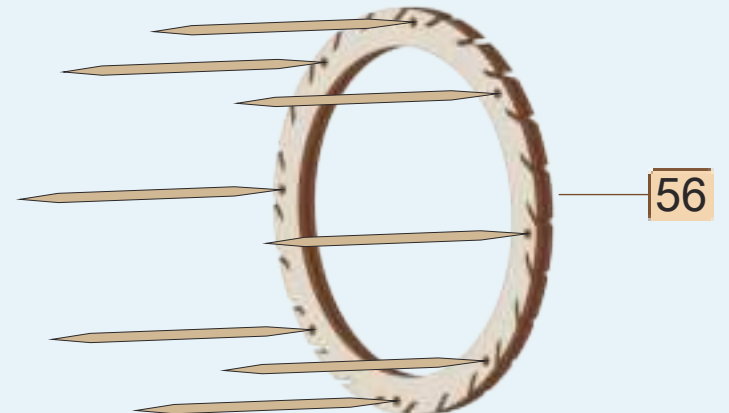
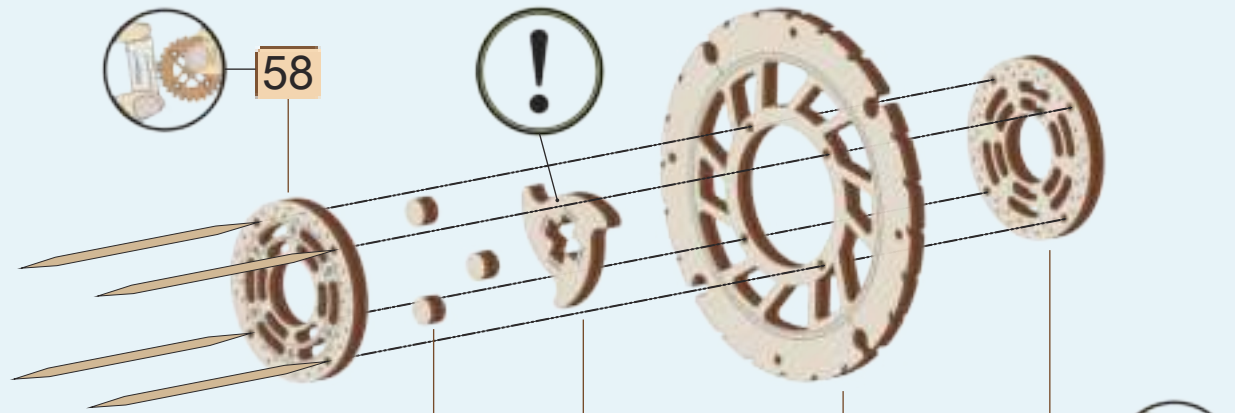

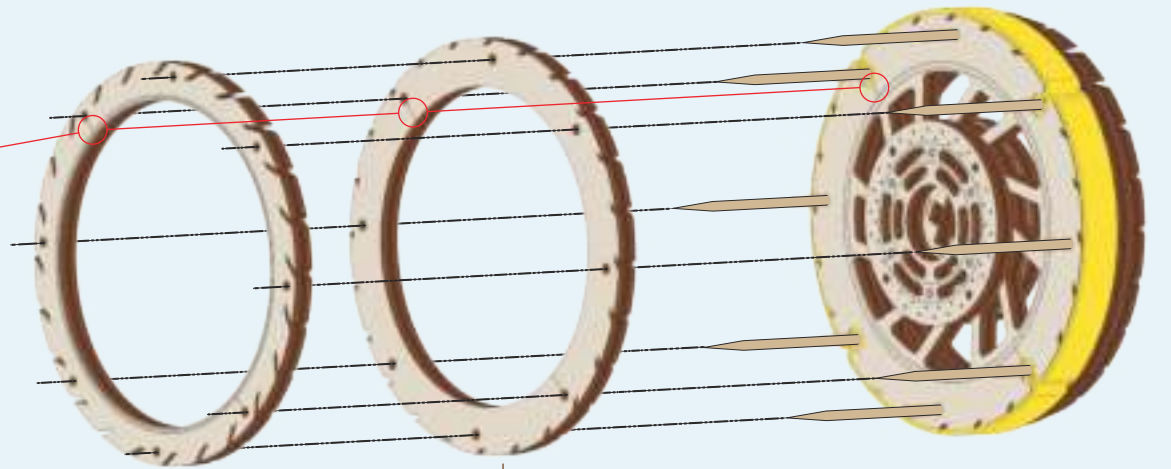
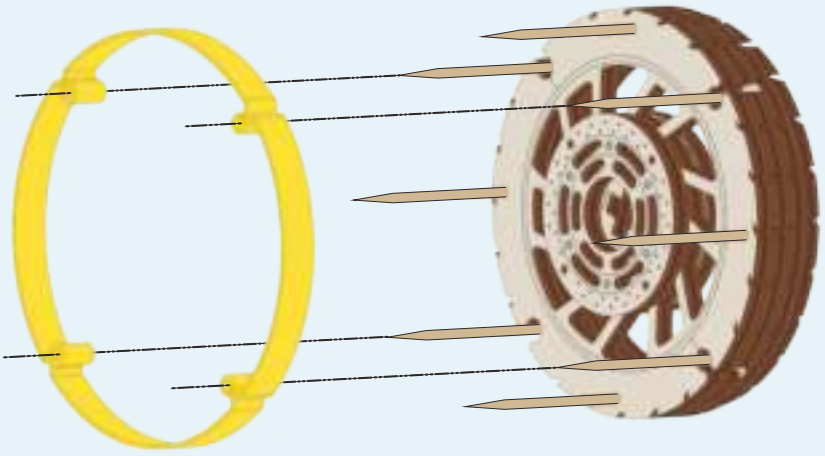

57

55

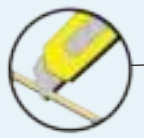

3

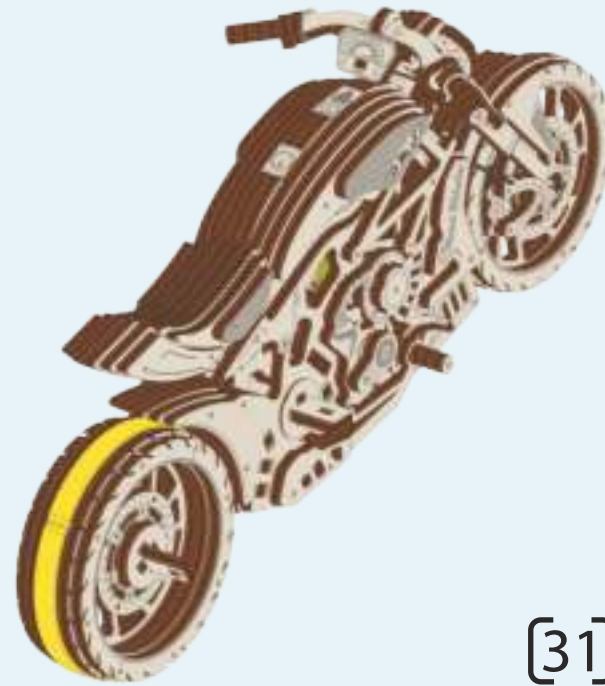
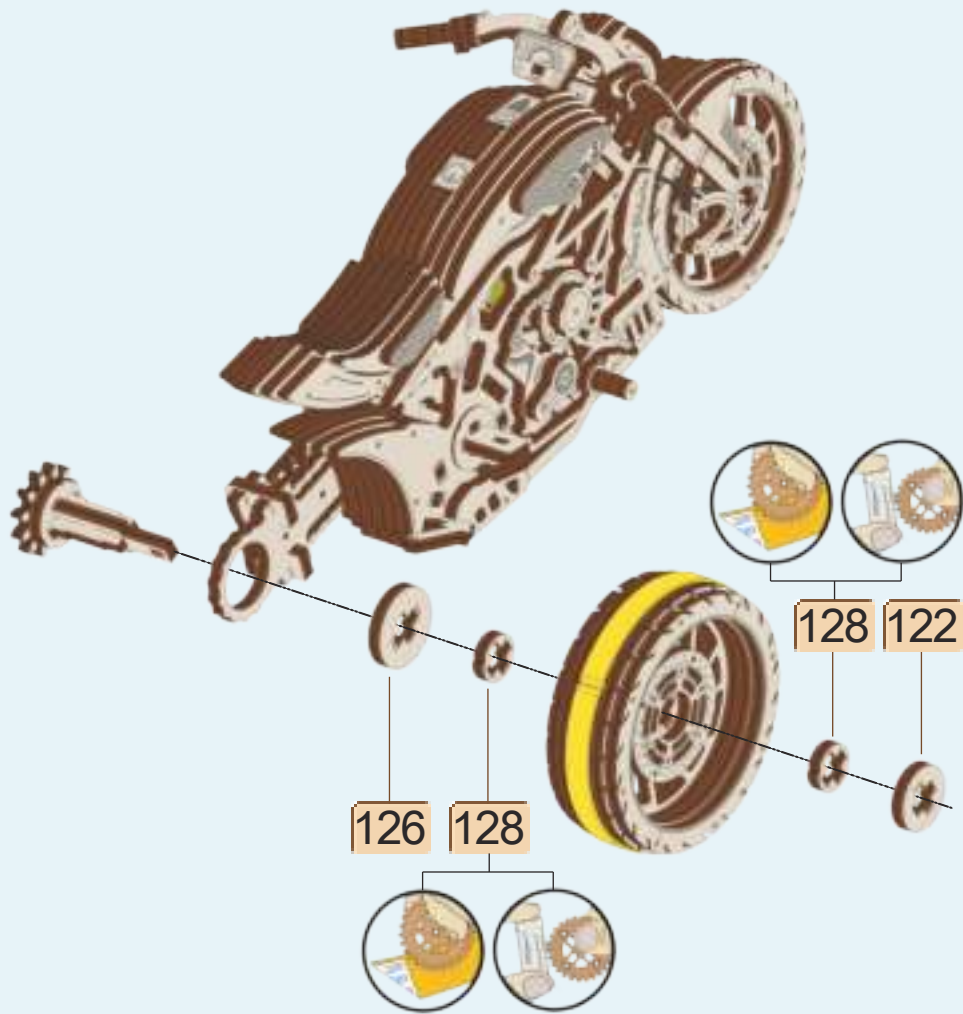
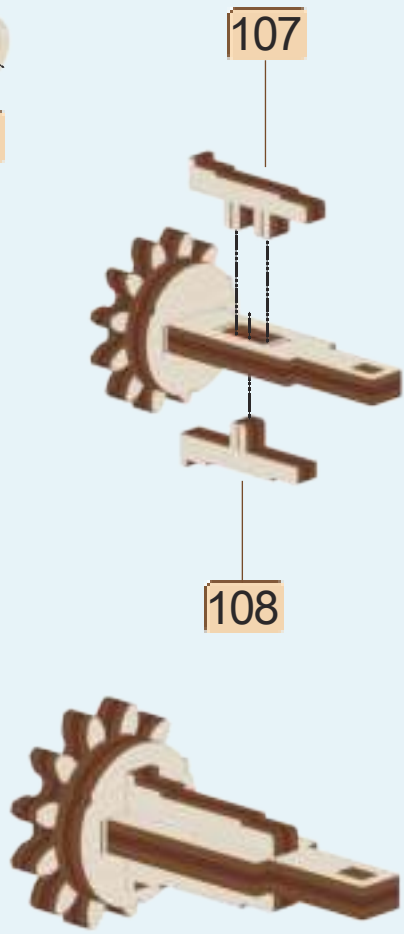
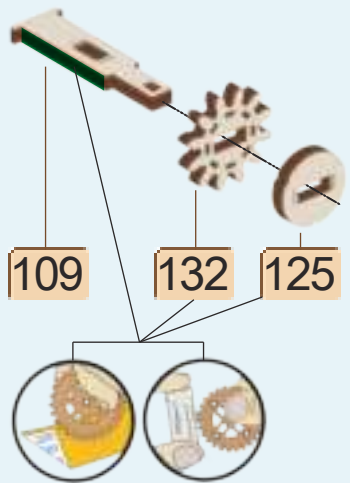

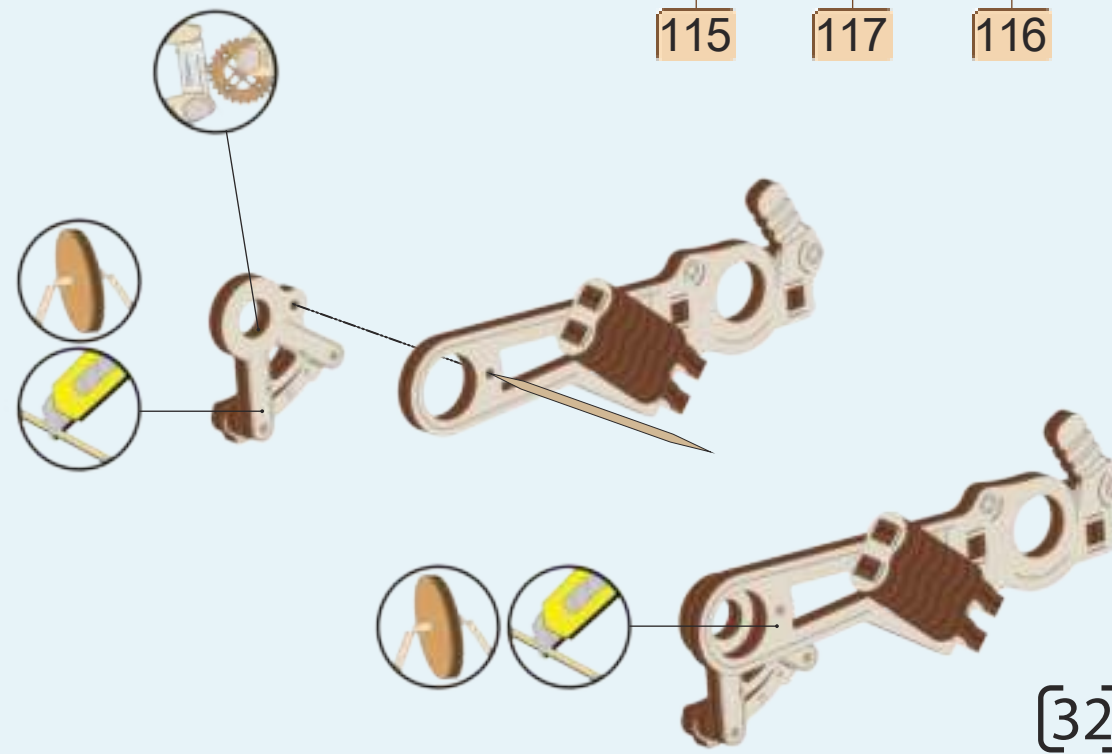
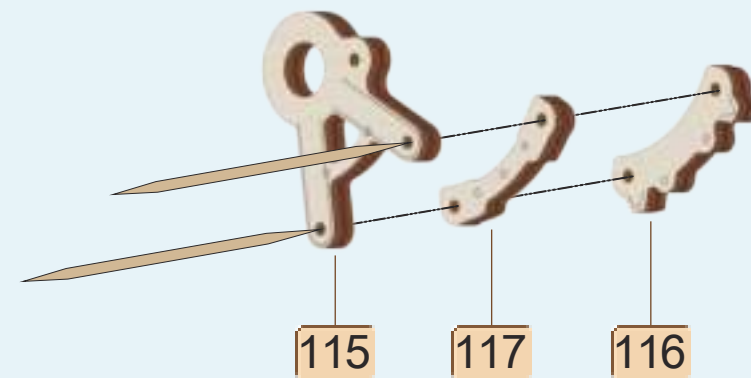
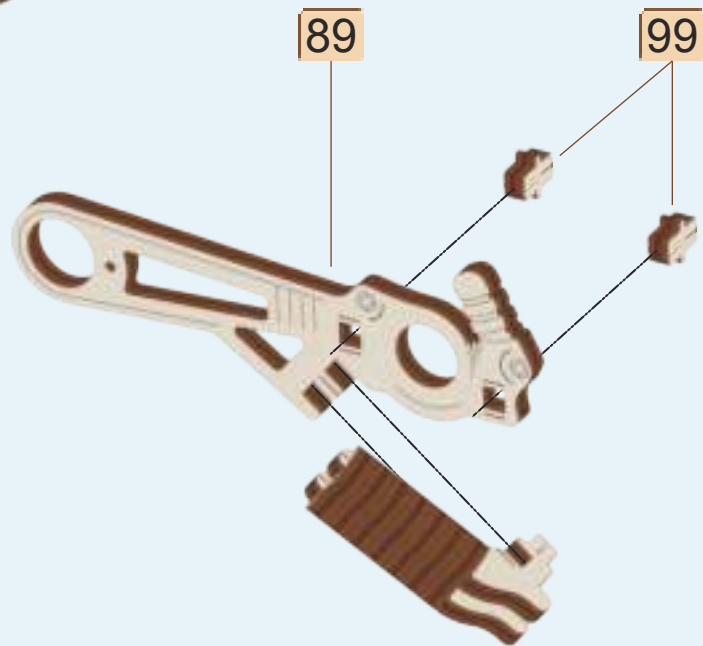
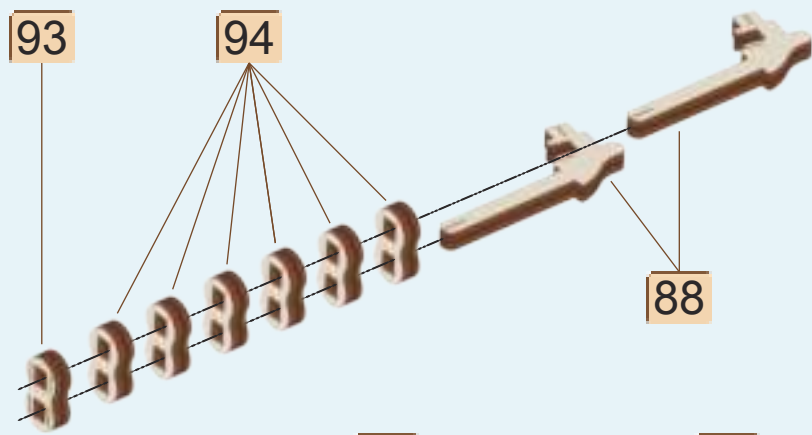

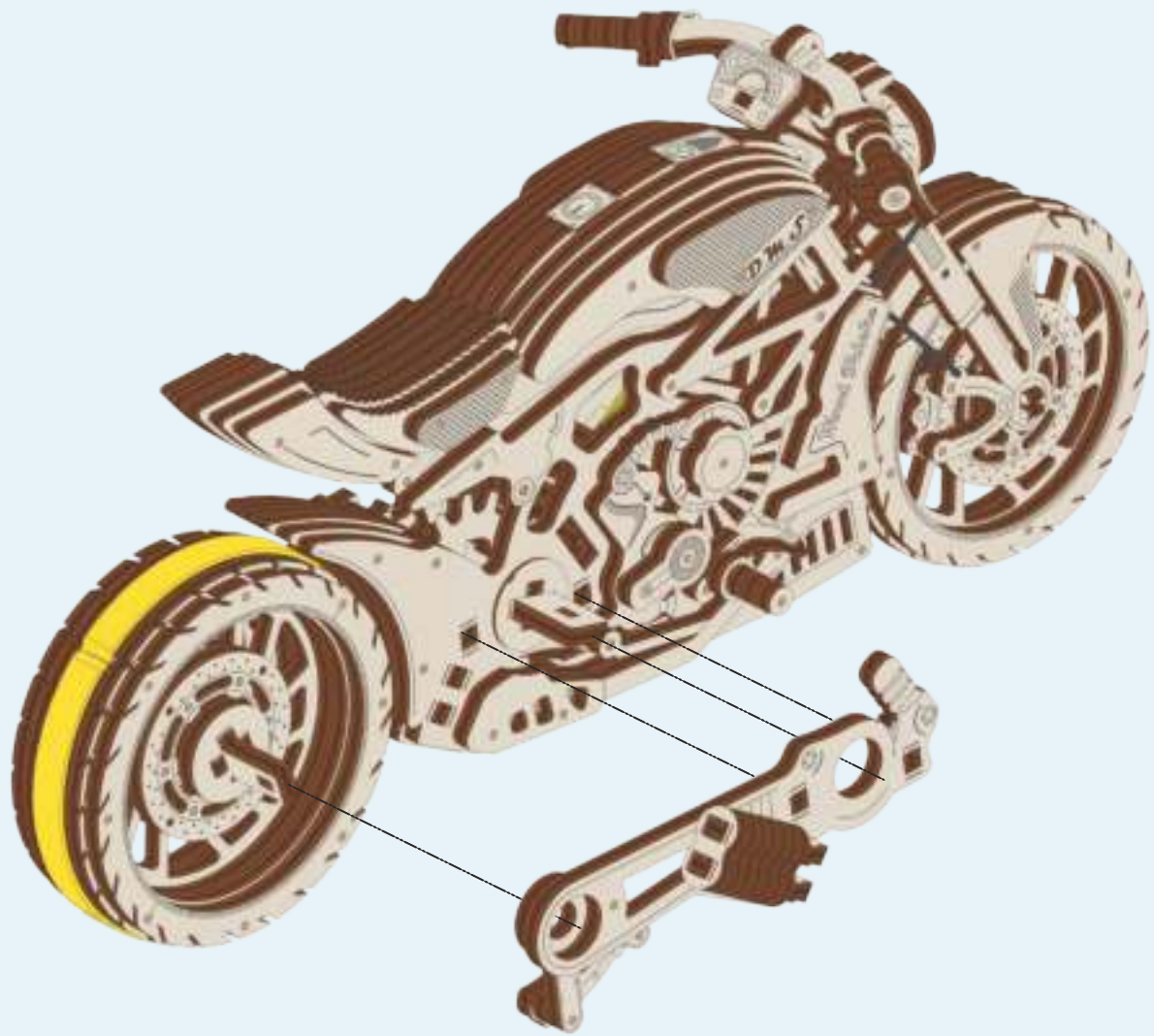

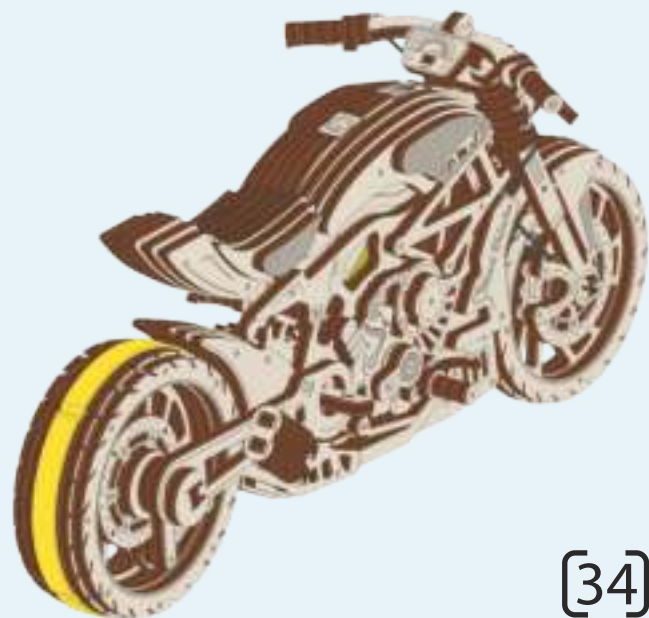
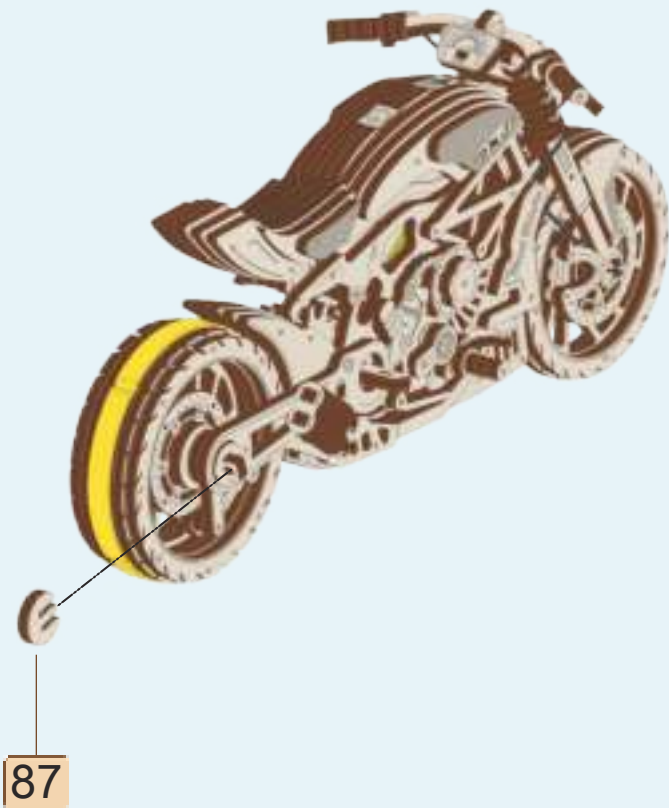
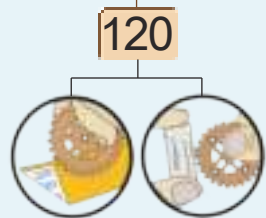



1



119

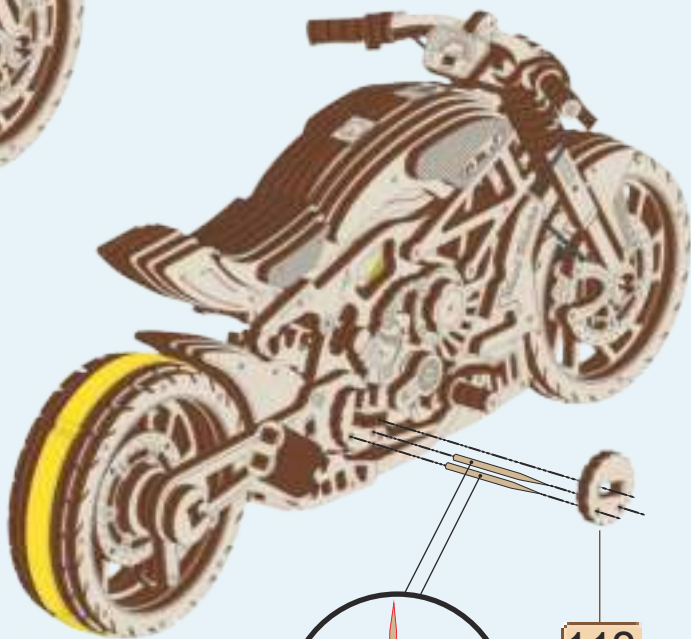

118



[35]

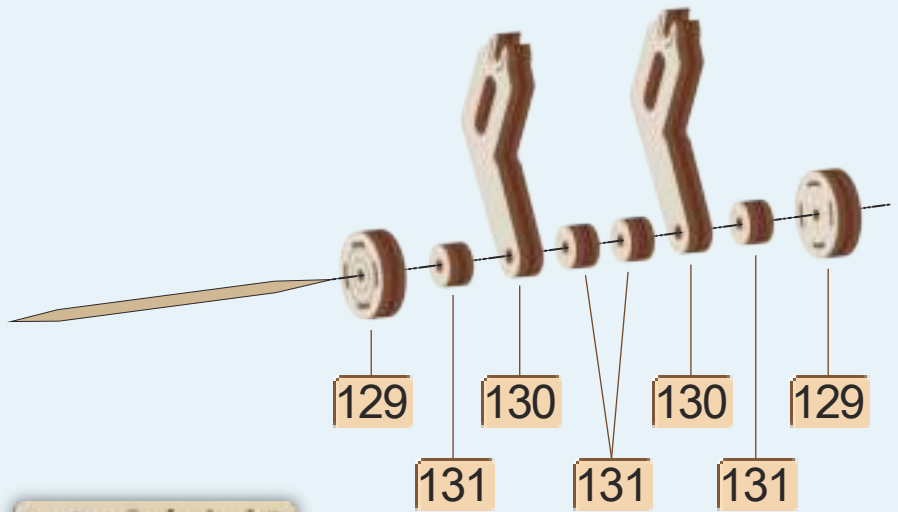

1

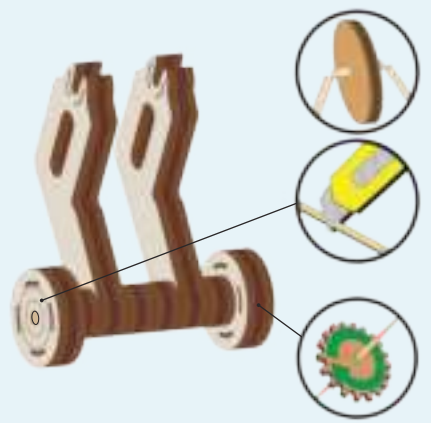

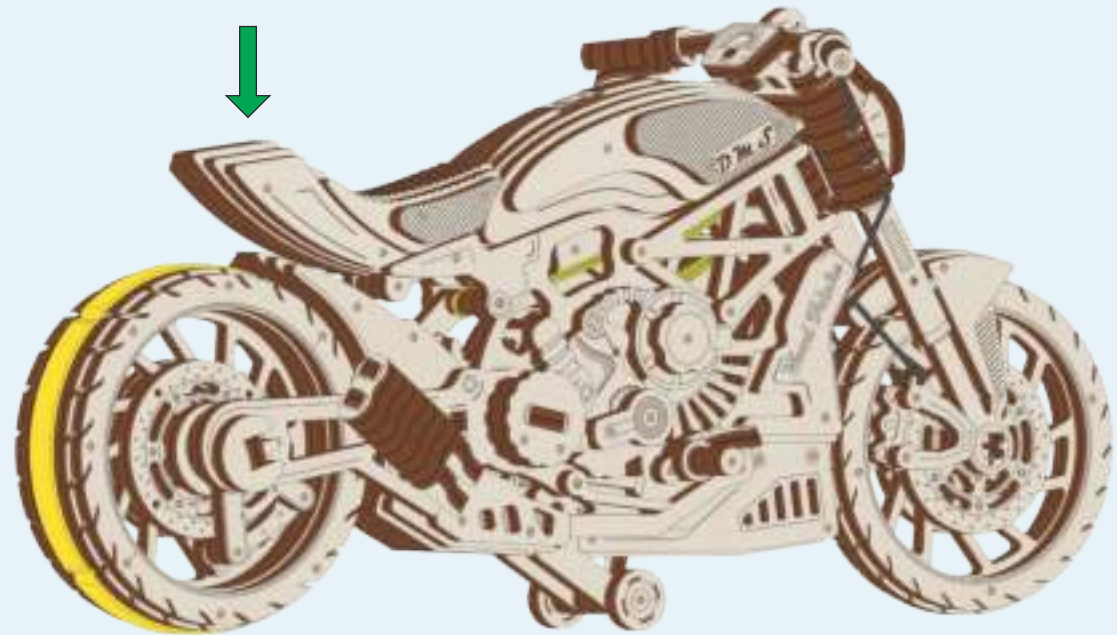
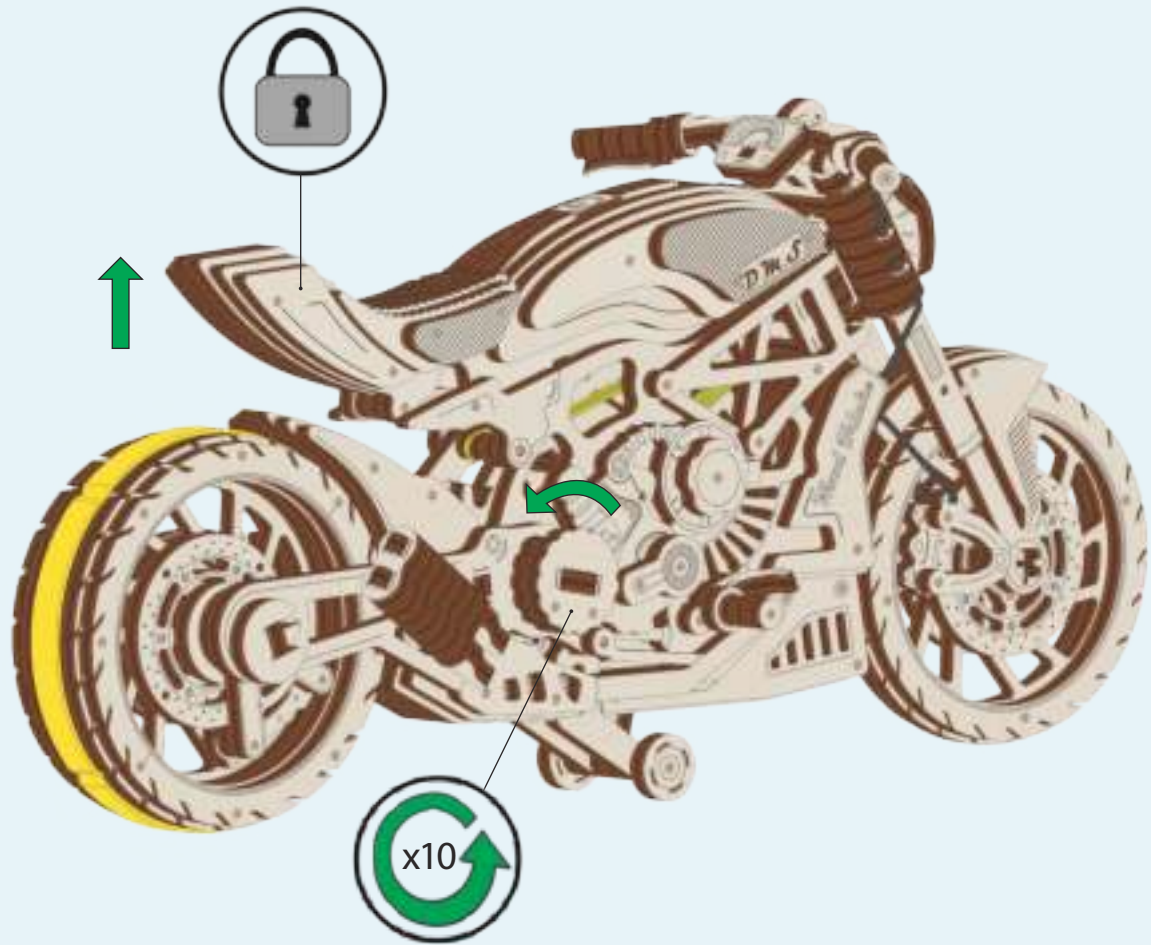

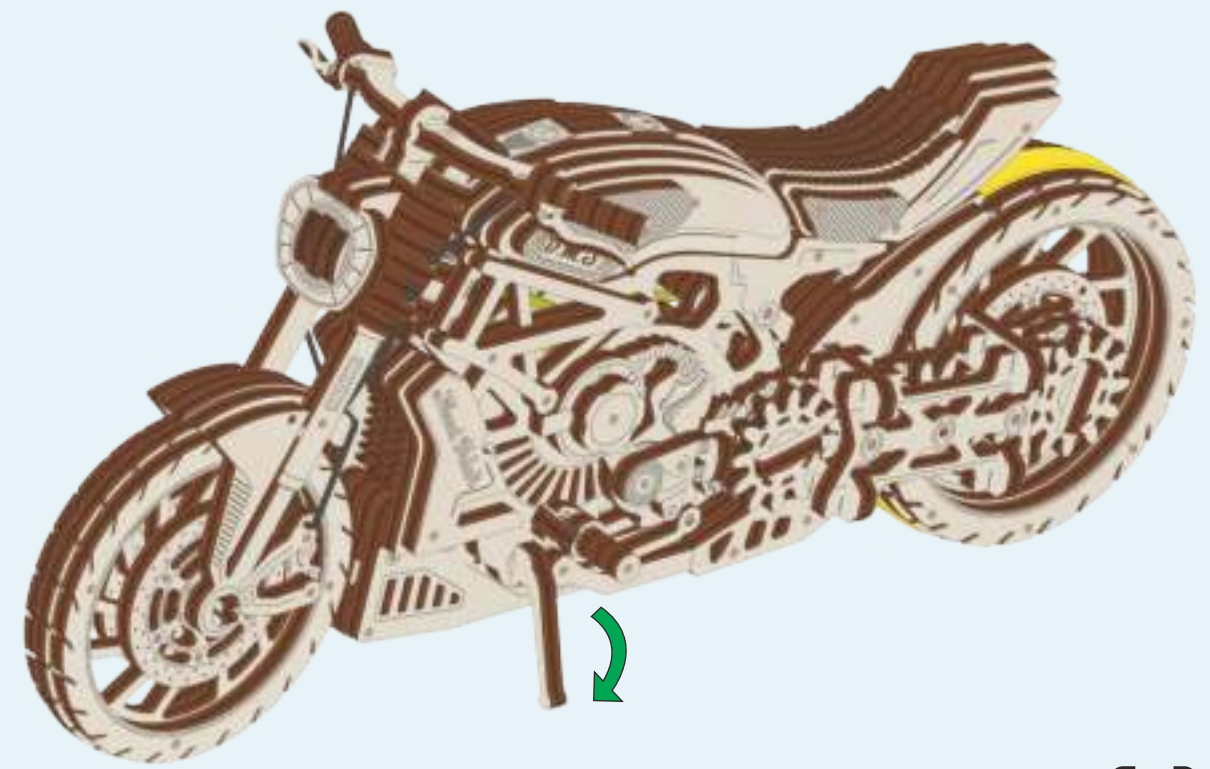
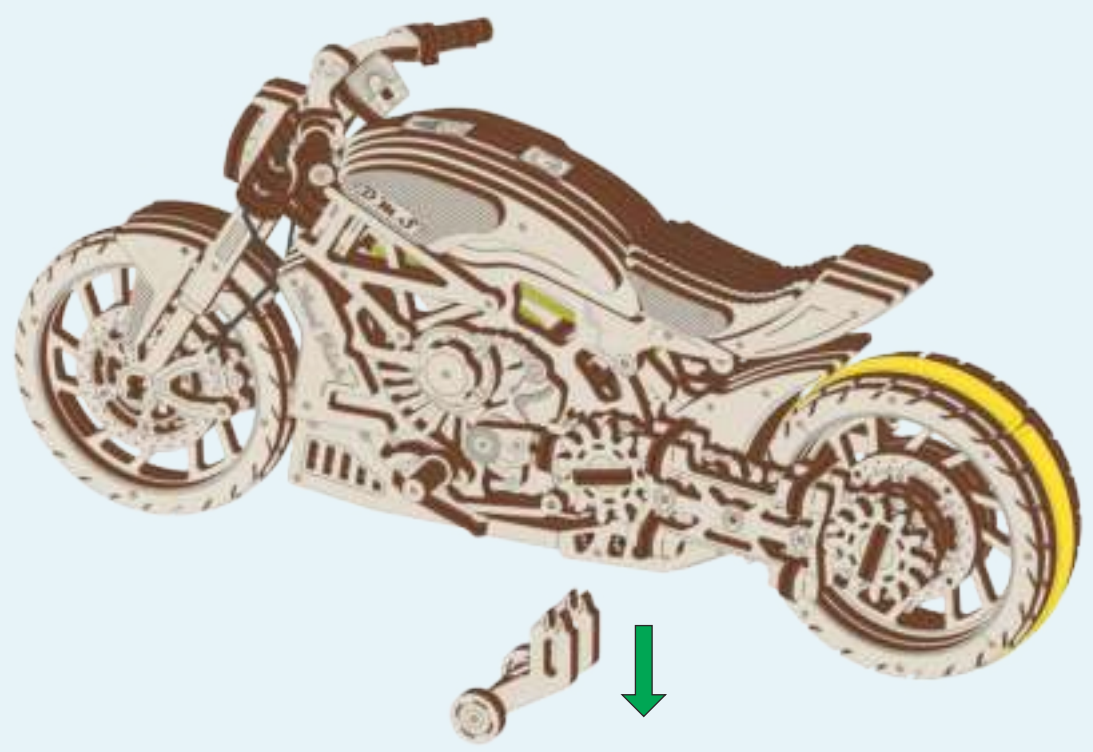

VRRROOOM VRRROOOM...

The rumbling of the engine, the speed that you can feel with your whole body, and the rapidly changing scenery in front of your eyes... The romance of motorcycle rides will never disappear. The two-wheeled mode of transport has many varieties, and there are millions of motorcycle fans and drivers worldwide. Therefore, we at Wood Trick decided to please all motorcyclists and create our prefabricated model, Motorcycle DMS.



THE FIRST MOTORCYCLE

The first motorcycle with a combustion engine was created in Germany in 1885. It was developed by engineers Gottlieb Daimler and Wilhelm Maybach. It could accelerate up to 12 kilometers per hour, and the patent for the device was registered even earlier than the patent for cars with internal combustion engines.

1894

The year motorcycles first began to be mass-produced. This model could already accelerate up to 45 kilometers per hour. The total produced in three years was about 2,000 motorcycles.

MOTORCYCLES AND WARS

During World War I, the motorcycle came to be seen as an essential means of transportation in combat situations. After it ended, this mode of transportation was greatly improved, and by the beginning of World War II, motorcycles became much more similar to today's models. They could cover long distances and reach a high speed.

Follow us on
[YouTube /woodtrick](#)
[Instagram @woodtrick](#)
www.woodtrick.com

WOOD TRICK

CHECK OUT OTHER SERIES



SPECIAL FORCES SERIES

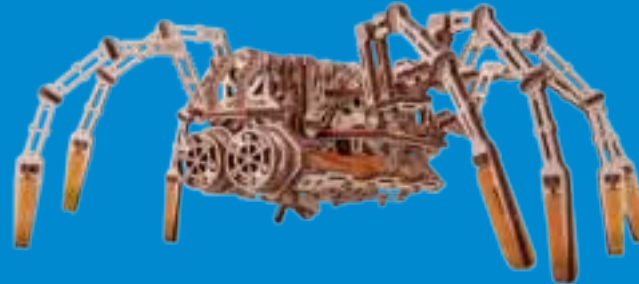

MECHANISMS SERIES

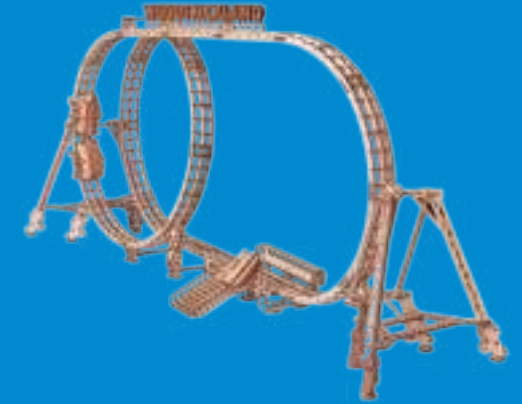

ELECTRIC SERIES

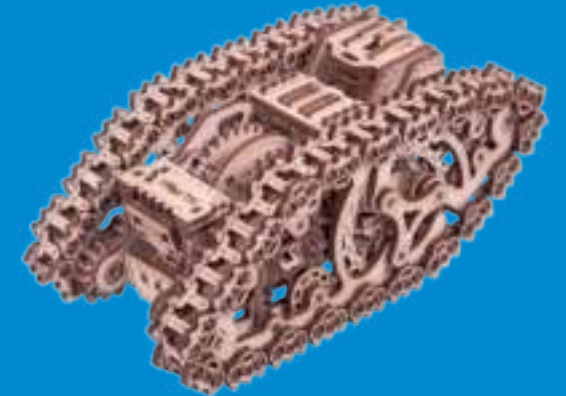

VINTAGE MACHINERY SERIES