

WOOD TRICK

MODERN
MACHINERY
SERIES

ENGINEERING
J0000000004



MECHANICAL MODELS & KITS

RESCUE FIRETRUCK



5 LEVEL

636
PIECES

WDTK091



EN Do not set fire to it! **UK** Не підпалювати! **DE** Nicht anzünden! **FR** Ne pas allumer! **IT** Non dare fuoco! **ES** No prender fuego! **PL** nie podpalaj! **JP** 火をつけないでください!



EN Caution! Sharp parts! **UK** Обережно! Гострі деталі! **DE** Vorsichtig! Scharfe Details! **FR** Attention Détails tranchants! **IT** Attenzione! Dettagli nitidi! **ES** Cuidado! Piezas cortantes! **PL** Uwaga! Ostre szczegóły! **JP** 気をつけて! 細部までシャープ!

EN Recommendation: if you have difficulty in connecting parts, treat toothpicks with paraffin. **UK** Рекомендація: якщо виникли складнощі при скріпленні деталей, обробіть зубочистки парафіном. **DE** Empfehlung: Wenn Sie Schwierigkeiten haben, Teile zu verbinden, behandeln Sie Zahnstocher mit Paraffin. **FR** Recommandation: si vous avez des difficultés pièces de fixation, traitez les cure-dents avec de la paraffine. **IT** Raccomandazione: in caso di difficoltà nel fissare le parti, trattare gli stuzzicadenti con paraffina. **ES** Recomendación: si tiene dificultades para fijar piezas, trate mondadientes con parafina. **PL** Zalecenie: jeśli masz trudności z połączeniem części, obsługiwać wykałaczki parafiną. **JP** 推奨事項: 部品を固定するとき問題がある場合は、つまようじをパラフィンで処理してください。

EN The assembling of constructor does not require to use glue. **UK** Конструктор не вимагає застосування клею. **DE** Für die Montage des Konstruktors ist kein Klebstoff erforderlich. **FR** Aucune colle n'est nécessaire pour monter le constructeur. **IT** L'assemblaggio non richiede l'uso di colla. **ES** El montaje constructor no requiere el uso de pegamento. **PL** Montaż konstruktora odbywa się bez kleju. **JP** 物を接着剤を使用する必要がありません。

EN Fragile details! Be careful when removing the constructor from the card! **UK** Крихкі деталі! Під час вилучення конструктора з карти будьте обережні! **DE** Zerbrechliche Details! Seien Sie vorsichtig, wenn Sie den Konstruktor von der Karte entfernen! **FR** Détails fragiles! Faites attention en retirant les éléments de la construction de la carte! **IT** Dettagli fragili! Gli elementi vanno estratti dalla scheda con cautela! **ES** Detalles frágiles! Sea prudente al sacar elementos de mecano del tarjeta! **PL** Kruche szczegóły! Przedmioty należy wyjmować z karty ostrożnie! **JP** 壊れやすい詳細物! マップからコンストラクター要素を抽出するときには注意してください。

EN All elements that interlock must be sanded with sandpaper and greased with paraffin. **UK** Всі елементи, що входять у зачеплення необхідно зачистити наждачним папером і змастити парафіном. **DE** Alle eingreifenden Teile müssen mit Sandpapier gereinigt und mit Paraffin eingefettet werden. **FR** Il faut nettoyer tous les éléments de l'accrochage à l'aide du papier-meri et les traiter avec de la paraffine. **IT** Tutti gli elementi agganciati devono essere puliti con carta vetrata e ingrassati con paraffina. **ES** Todos los elementos que se enganchan deben limpiarse con papel de lija y engrasarse con parafina. **PL** Wszystkie zaczeplone elementy należy oczyścić papierem ściernym i nasmarować parafiną. **JP** すべての係合要素はサンドペーパーで清掃し、パラフィンで潤滑する必要があります。

EN Design kit can be tightly connected in some places, so that the assembled model has solidity and reliability. We recommend using pliers and box cutter for a more convenient design kit assembly. **UK** Конструктор може в деяких місцях туго з'єднатися, для того, щоб зібрана модель мала міцність та надійність. Для більш зручної збірки конструктора, рекомендуємо використовувати плоскогубці та канцелярський ніж. **DE** Der Konstruktor kann an einigen Stellen keine gute Verbindung herstellen, so daß das zusammengebaute Modell eine ausreichende Festigkeit und Zuverlässigkeit aufweist. Für eine bequemere Montage des Konstruktors empfehlen wir die Verwendung einer Zange und eines Schreibwarenmessers. **FR** Le jeu de construction peut être étroitement connecté à certains endroits, pour que le modèle assemblé soit solide et fiable. Pour un assemblage plus pratique de jeu de construction, nous vous recommandons d'utiliser une pince et un couteau à papeterie. **IT** Le jeu de construction peut être étroitement connecté à certains endroits, pour que le modèle assemblé soit solide et fiable. Pour un assemblage plus pratique de jeu de construction, nous vous recommandons d'utiliser une pince et un couteau à papeterie. **ES** Le jeu de construction peut être étroitement connecté à certains endroits, pour que le modèle assemblé soit solide et fiable. Pour un assemblage plus pratique de jeu de construction, nous vous recommandons d'utiliser une pince et un couteau à papeterie. **PL** Le jeu de construction peut être étroitement connecté à certains endroits, pour que le modèle assemblé soit solide et fiable. Pour un assemblage plus pratique de jeu de construction, nous vous recommandons d'utiliser une pince et un couteau à papeterie. **JP** このものは所々でしっかりと接続できるため、組み立てられたモデルの強度と信頼性が高くなります。設計者がより便利に組み立てるために、ペンチと事務用ナイフを使用することをお勧めします。



EN Warning! For the correct operation of this model, it is necessary to clean carefully and to lubricate all rubbing parts with paraffin during assembly. All mechanisms must rotate freely. **UK** Увага! Для коректної роботи даної моделі, необхідно при збірці ретельно зачищати, змащувати парафіном усі деталі, які труться. Усі механізми повинні вільно обертатися. **DE** Hinweis! Für einen korrekten Betrieb dieses Modells ist bei dem Zusammenbau erforderlich, alle Reibteile sorgfältig auszusmieren und mit Paraffin zu schmieren. Alle Bauteile sollen sich frei drehen. **FR** Attention ! Pour le bon fonctionnement de ce modèle, il est nécessaire lors du montage de nettoyer et lubrifier soigneusement toutes les pièces à friction avec de la paraffine. Tous les mécanismes doivent tourner librement. **IT** Attenzione! Per il corretto funzionamento di questo modello, durante il montaggio, è necessario pulire e lubrificare accuratamente tutte le parti di sfregamento con paraffina. Tutti i meccanismi devono ruotare liberamente. **ES** ¡Atención! Para el funcionamiento adecuado de este modelo a la hora de ensamblaje se recomienda alisar y lubricar cuidadosamente con parafina todos los detalles frotantes. Todos los mecanismos deben girar libremente. **PL** Uwaga! Aby ten model działał prawidłowo, podczas montażu wszystkie detale trące muszą być dokładnie oczyszczone i nasmarowane parafiną. Wszystkie mechanizmy muszą się swobodnie obracać. **JP** 注意! このモデルを正しく動作させるには、組み立て中に擦れるすべての部品を慎重に洗浄し、パラフィンで潤滑する必要があります。すべての機構は自由に回転する必要があります。

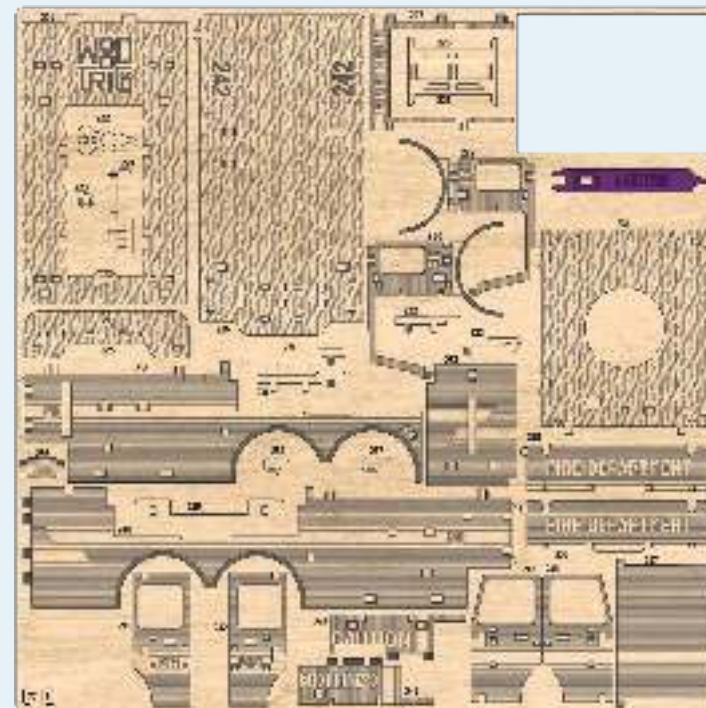
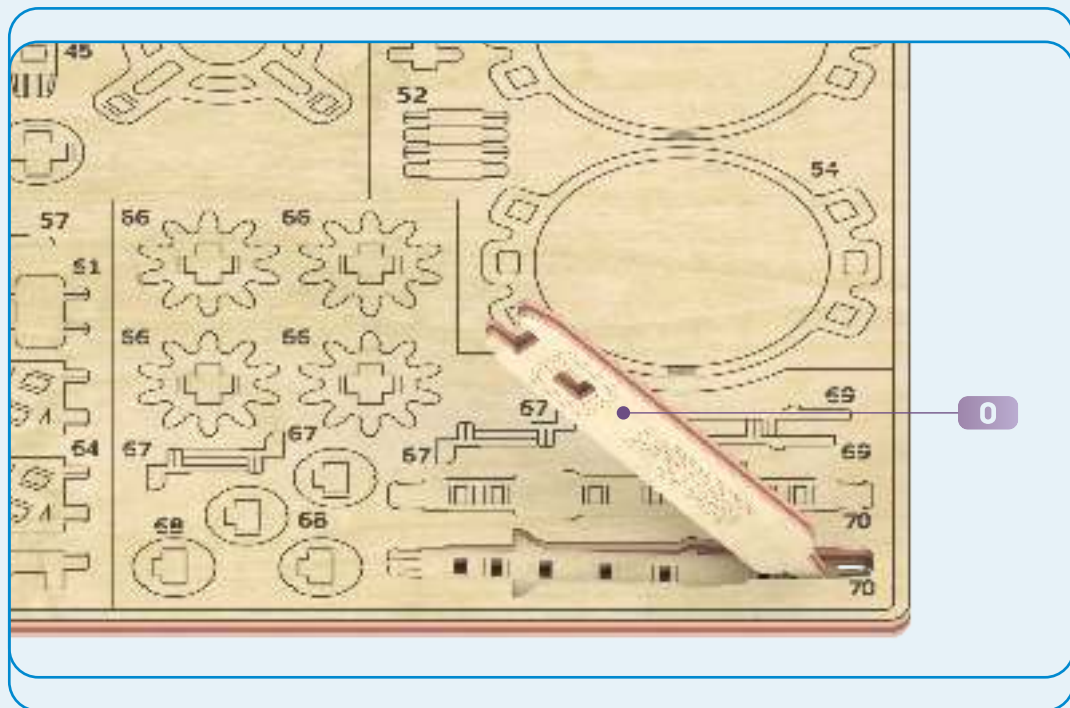

EN Auxiliary tool for assembling or measuring distances. **UK** Допоміжний інструмент для збірки або вимірювання відстаней. **DE** Hilfswerkzeug zum Montieren oder Messen von Abständen. **FR** Outil auxiliaire pour assembler ou mesurer des distances. **IT** Strumento ausiliario per l'assemblaggio o la misurazione delle distanze. **ES** Herramienta auxiliar para ensamblar o medir distancias. **PL** Narzędzie pomocnicze do montażu lub pomiaru odległości. **JP** 組立や距離測定用の補助工具です。

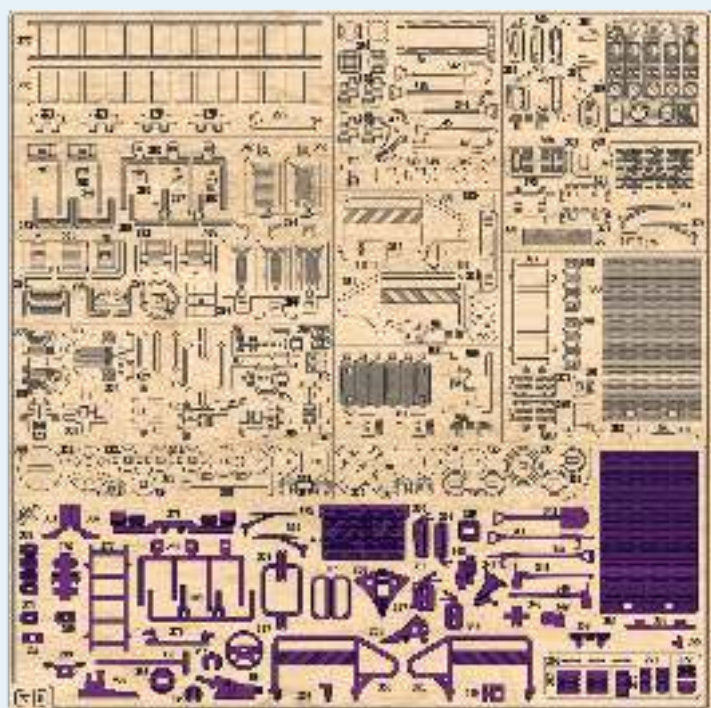
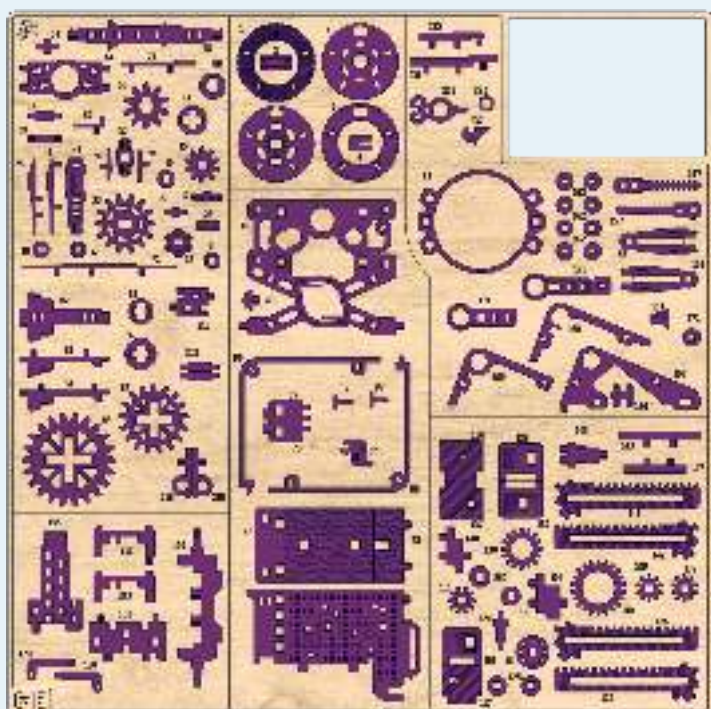

EN Spare parts. **UK** Запасні деталі. **DE** Ersatzteile. **FR** Pièces de rechange. **IT** Pezzi di ricambio. **ES** Repuestos. **PL** Części zamienne. **JP** 予備部品。

EN Symbolic notations. **UK** Умовні позначення. **DE** Erläuterungen. **FR** Légende. **IT** Notazioni simboliche. **ES** Notaciones simbólicas. **PL** Notacje symboliczne. **JP** 従来の呼び名。



EN Remove burrs. **UK** Видалити задирки. **DE** Niednägel entfernen. **FR** Enlever les bavures. **IT** Eliminare le bave. **ES** Quitar rebabas. **PL** Usuń zadziory. **JP** バリを取り除きます。



EN Lubricate with paraffin. **UK** Змастити парафіном. **DE** Mit dem Paraffin schmieren. **FR** Lubrifier à la paraffine. **IT** Lubrificare con paraffina. **ES** Lubricar con parafina. **PL** Nasmaruj parafiną. **JP** パラフィンで潤滑します。

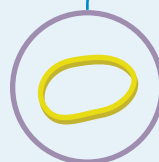

EN Rubber band. **UK** П езинка. **DE** Gummiband. **FR** Elastique. **IT** Gomma. **ES** De goma. **PL** Guma. **JP** ゴム。



EN Note! **UK** Звернути увагу! **DE** Aufgepasst! **FR** Faites attention! **IT** Presta attenzione! **ES** ¡Presta atención! **PL** Uwaga! **JP** 注意!

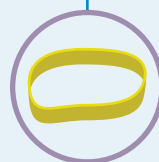

EN Wide rubber band. **UK** Широка резинка. **DE** Breites Gummiband. **FR** Large bande élastique. **IT** Ampio elastico. **ES** Banda de goma ancha. **PL** Szeroka gumka. **JP** 広いゴム。



EN Start the mechanism. **UK** Звести механізм. **DE** Starten Sie den Mechanismus. **FR** Démarrer le mécanisme. **IT** Avvia il meccanismo. **ES** Dar vuelta el mecanismo. **PL** Zapusc mechanizm. **JP** メカニズムを開始します。

3

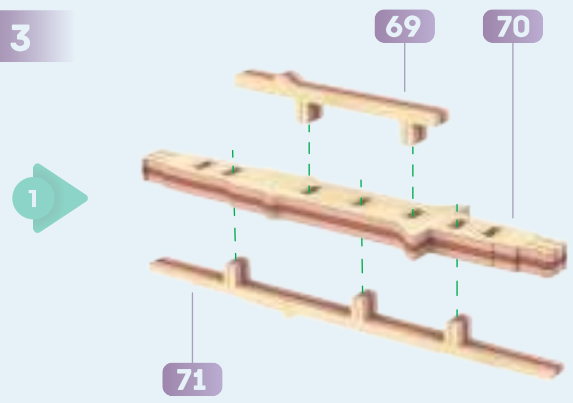

2

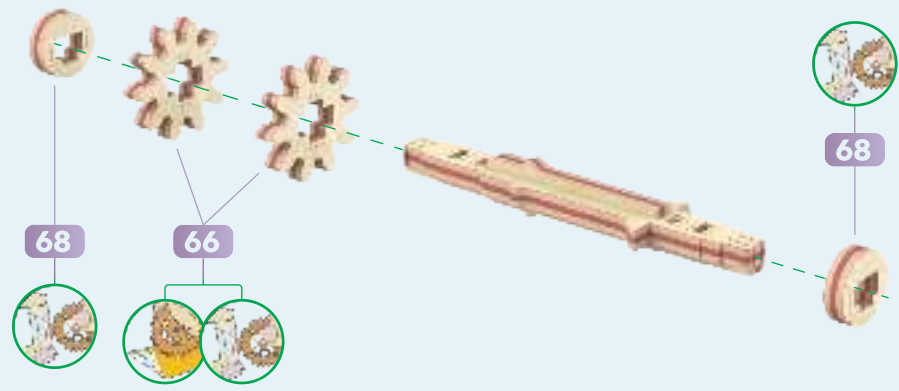

3

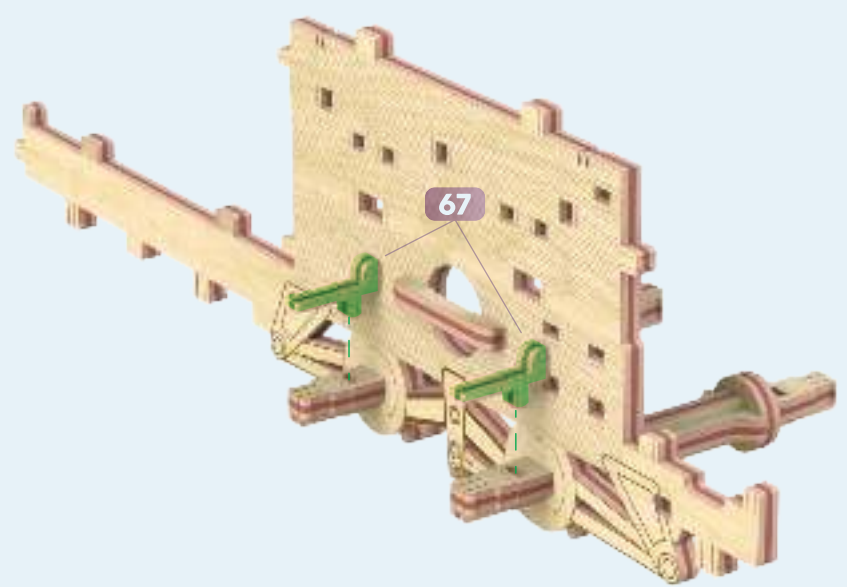
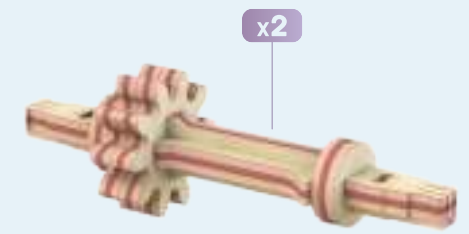

5

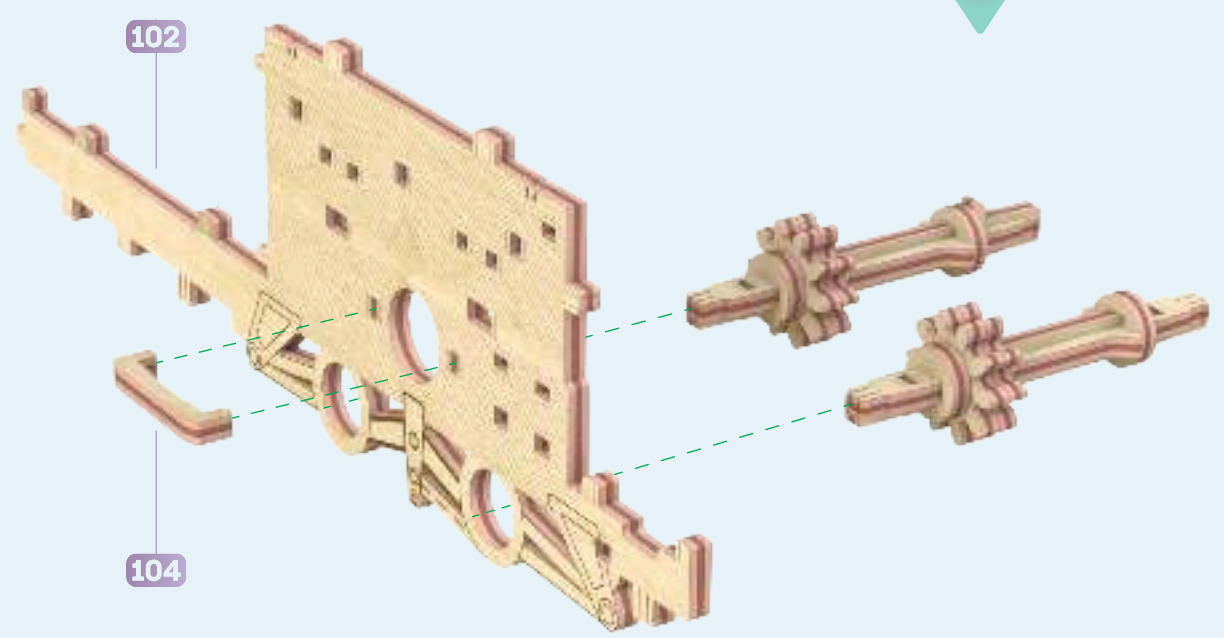

4

6

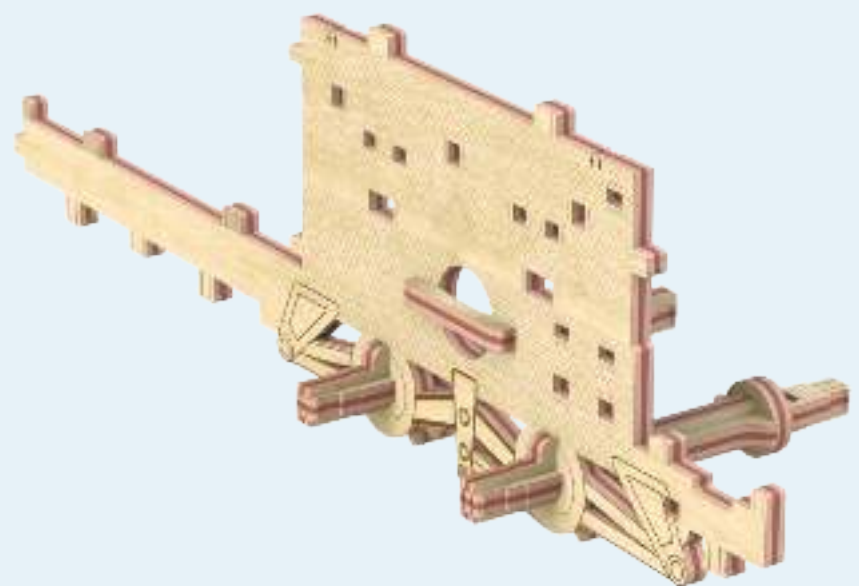

1

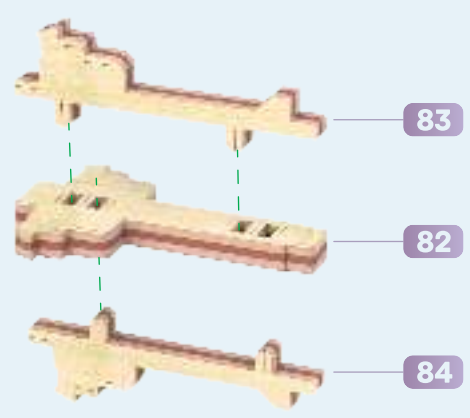

2

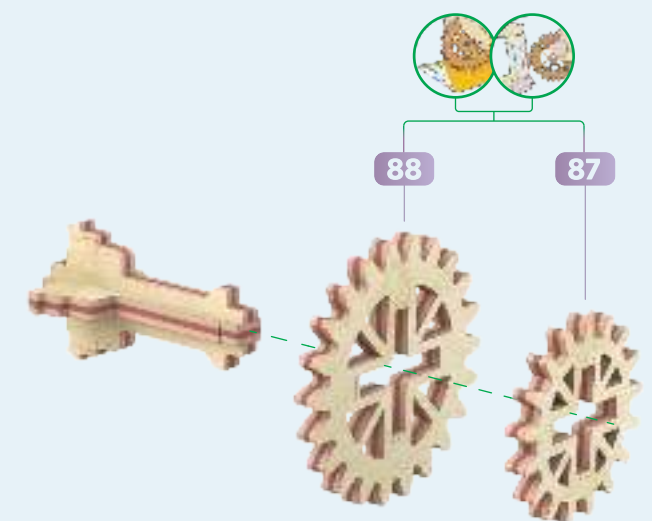

3

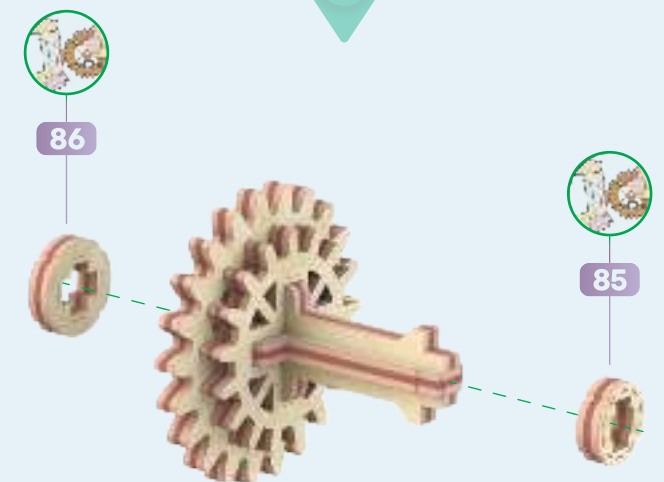

4

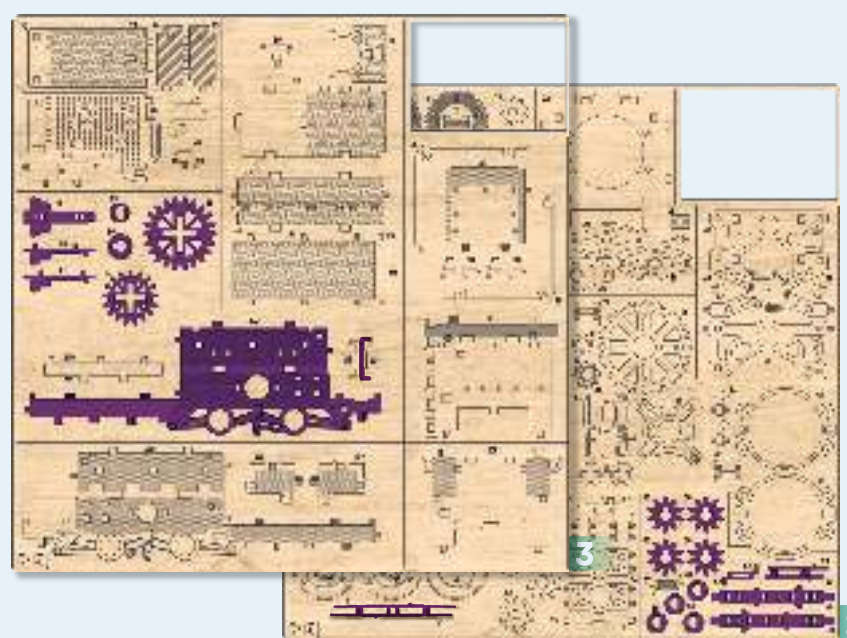
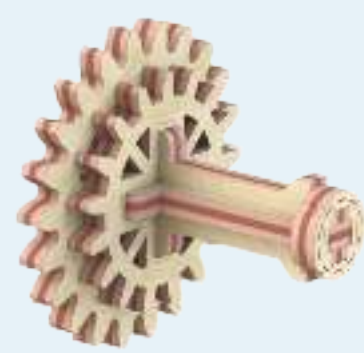

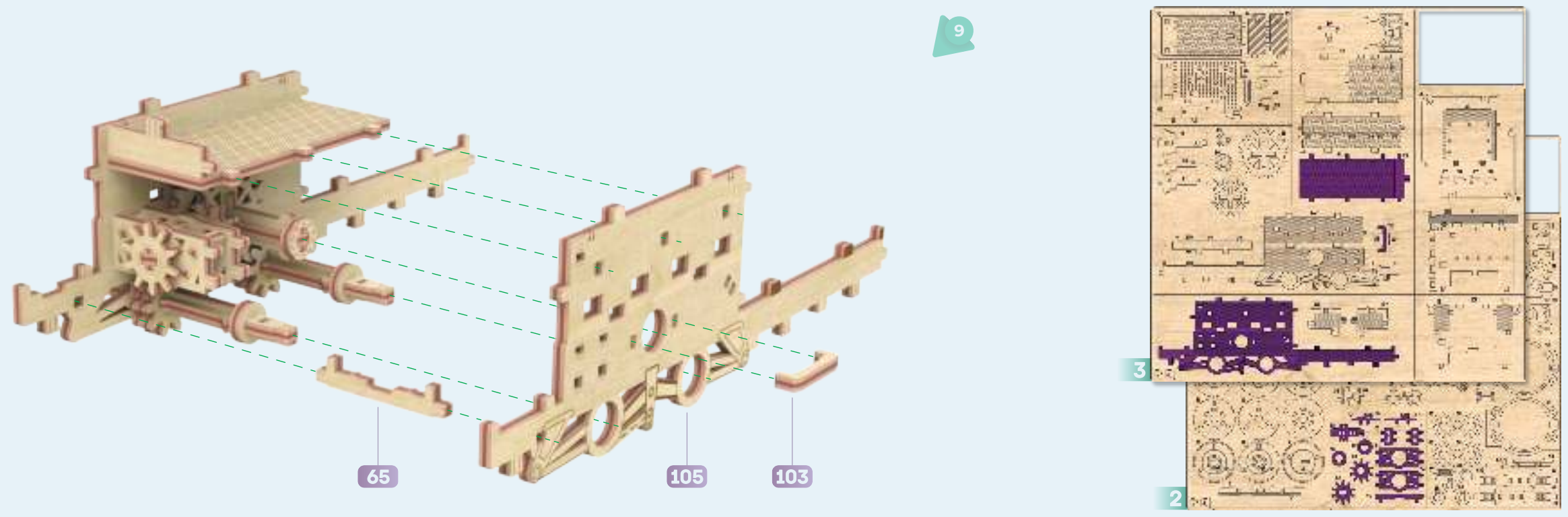
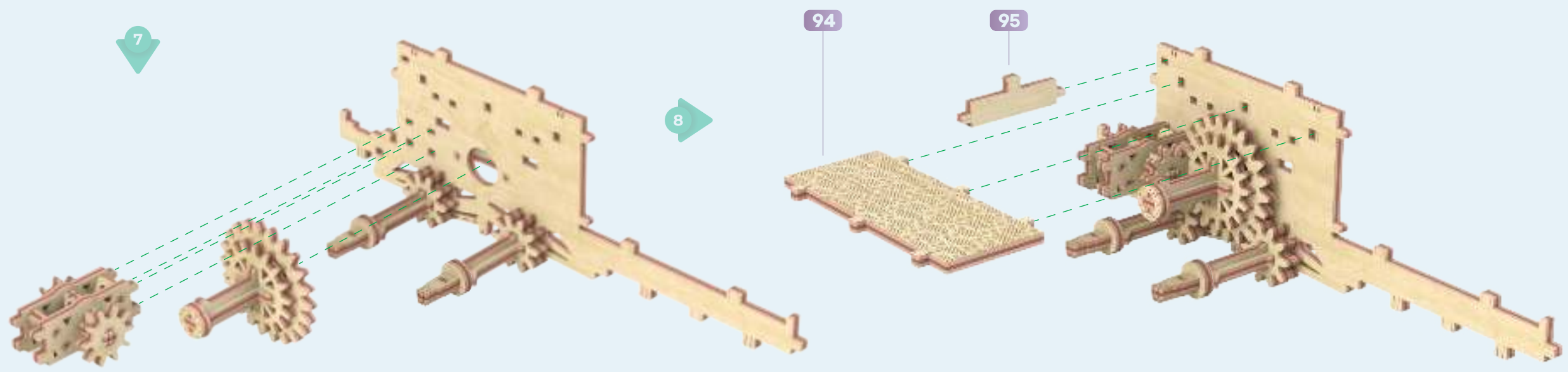
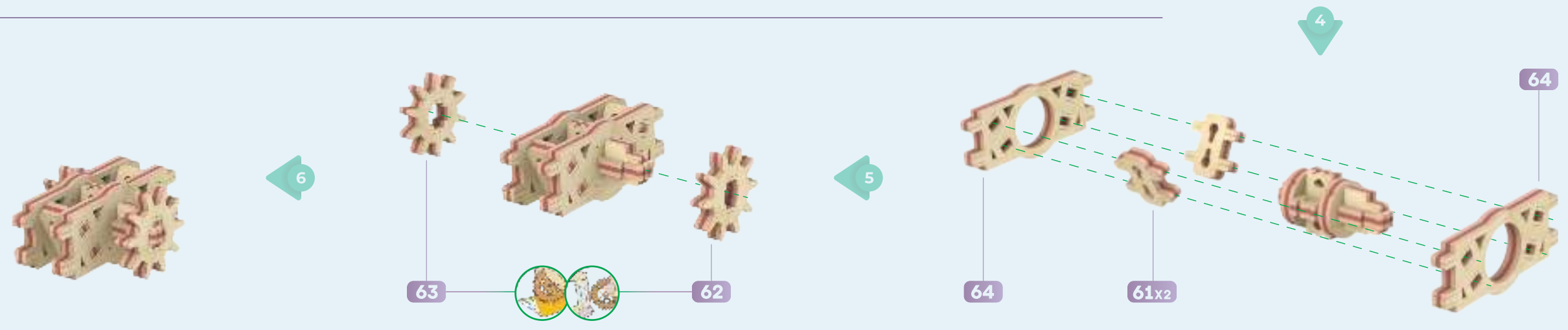
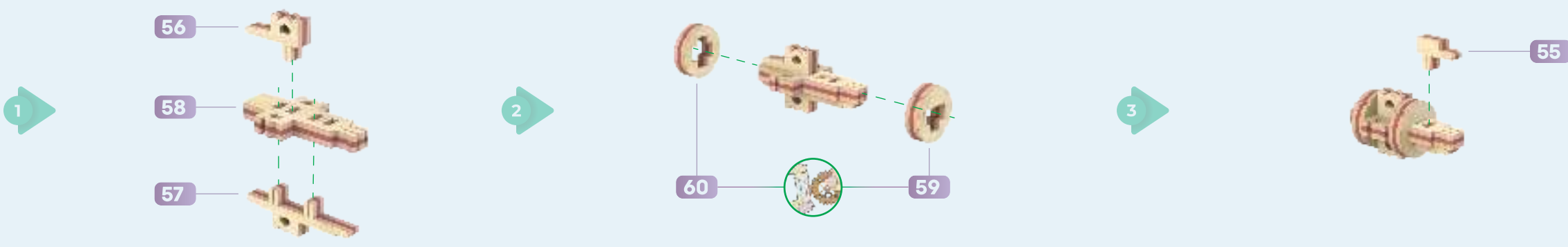

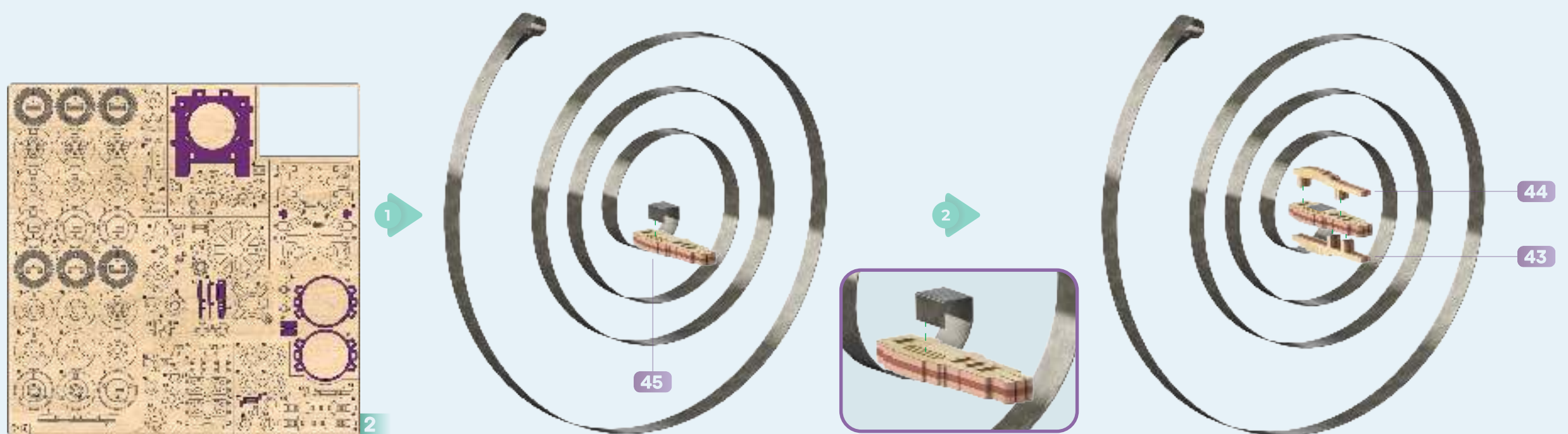
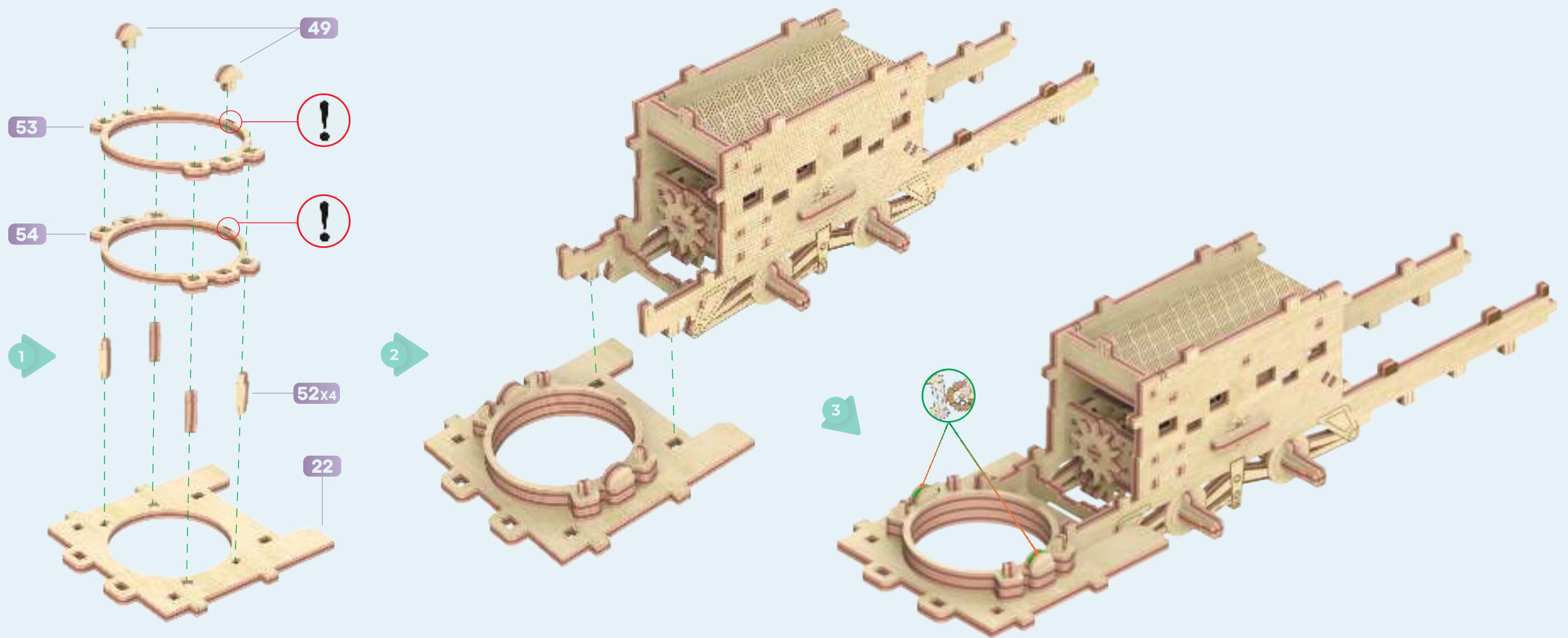
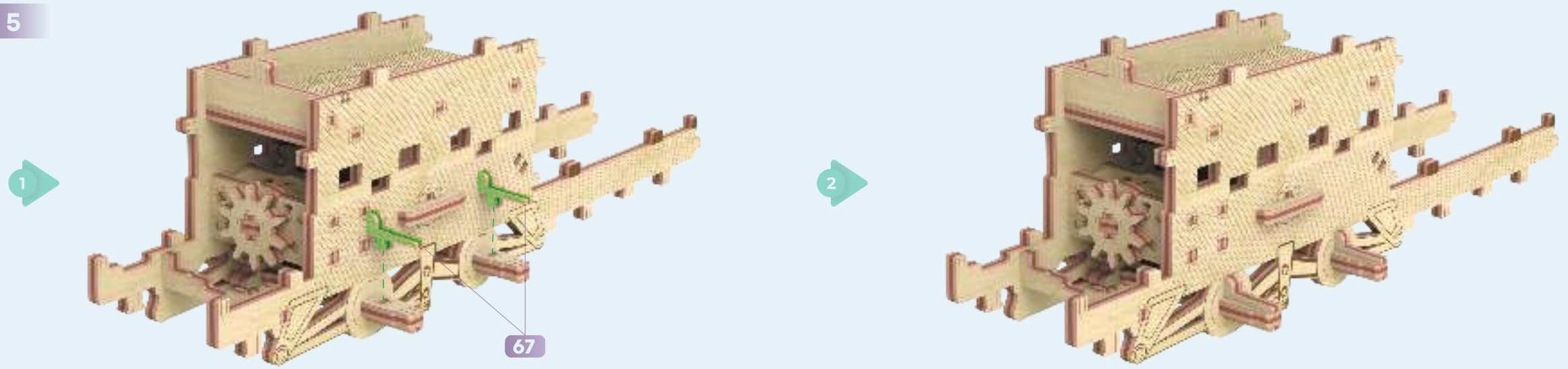

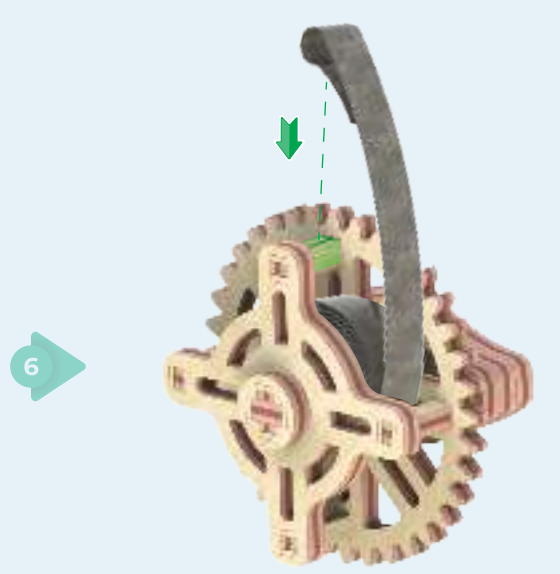
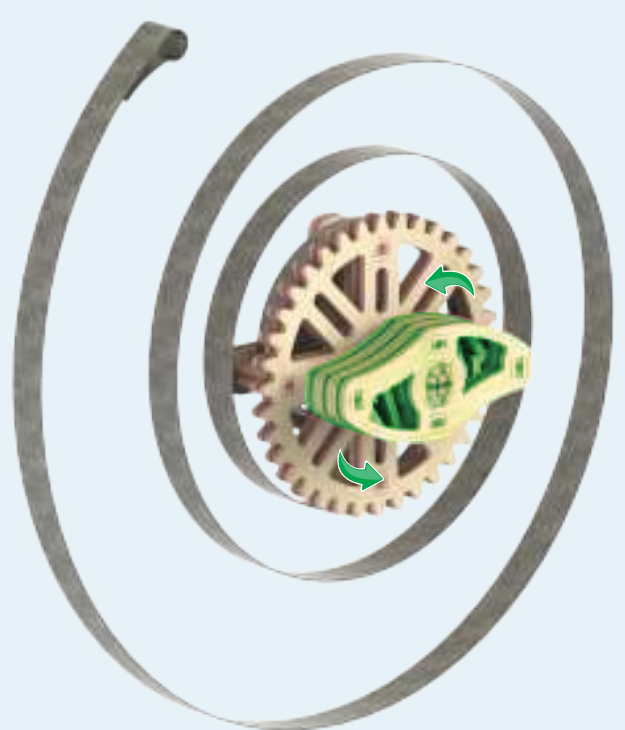
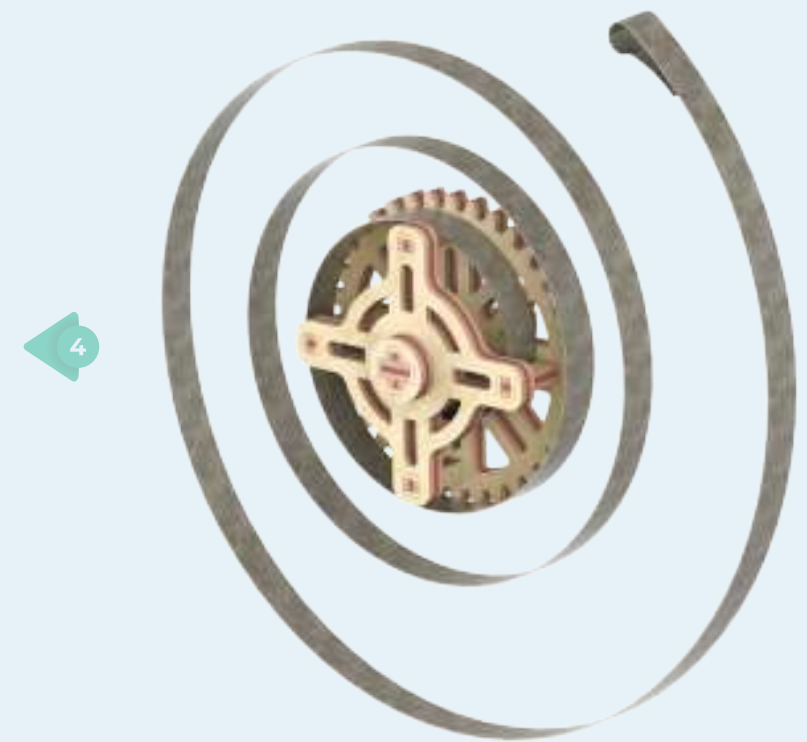
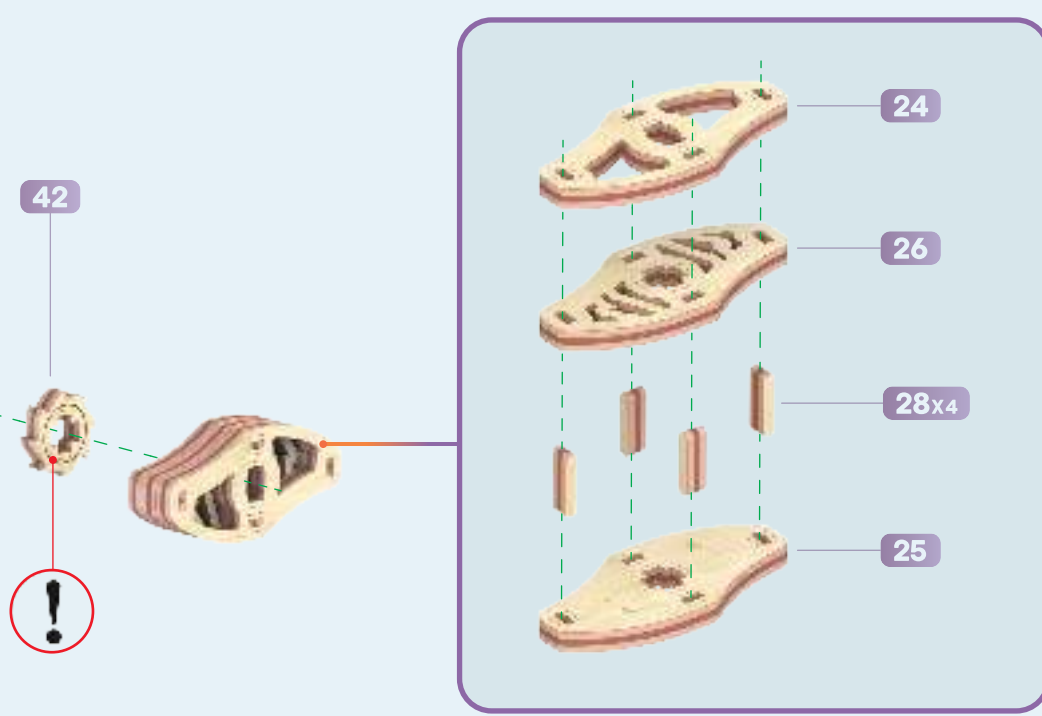
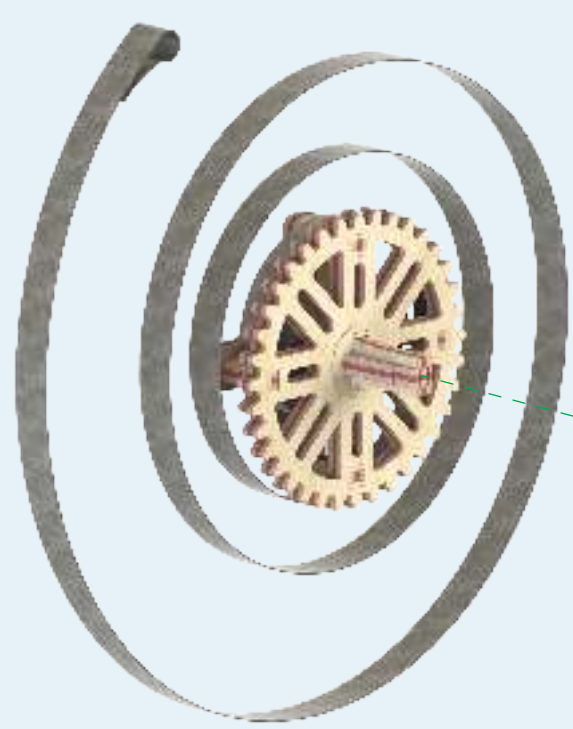
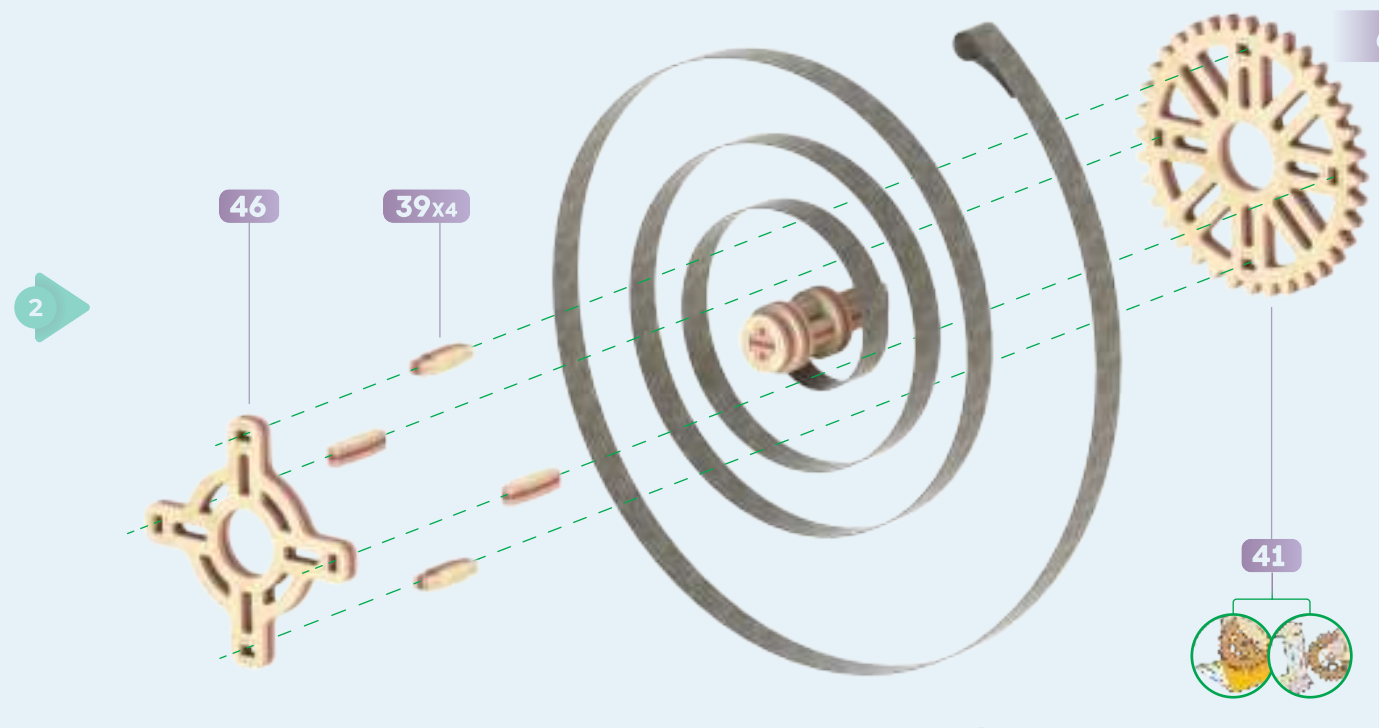
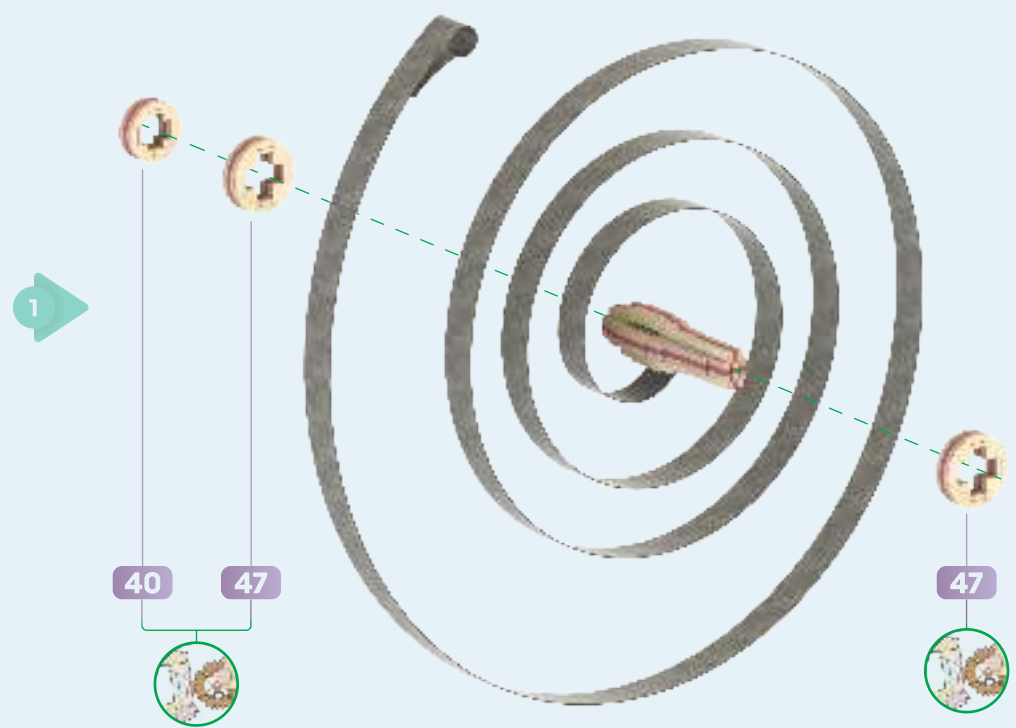

7

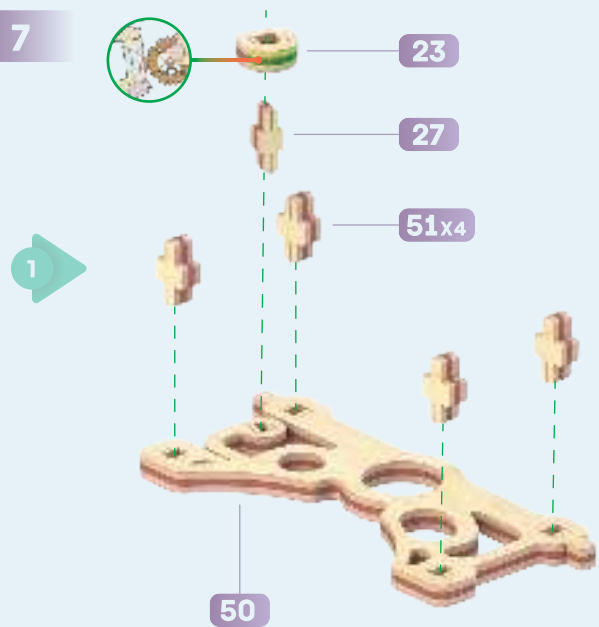

2

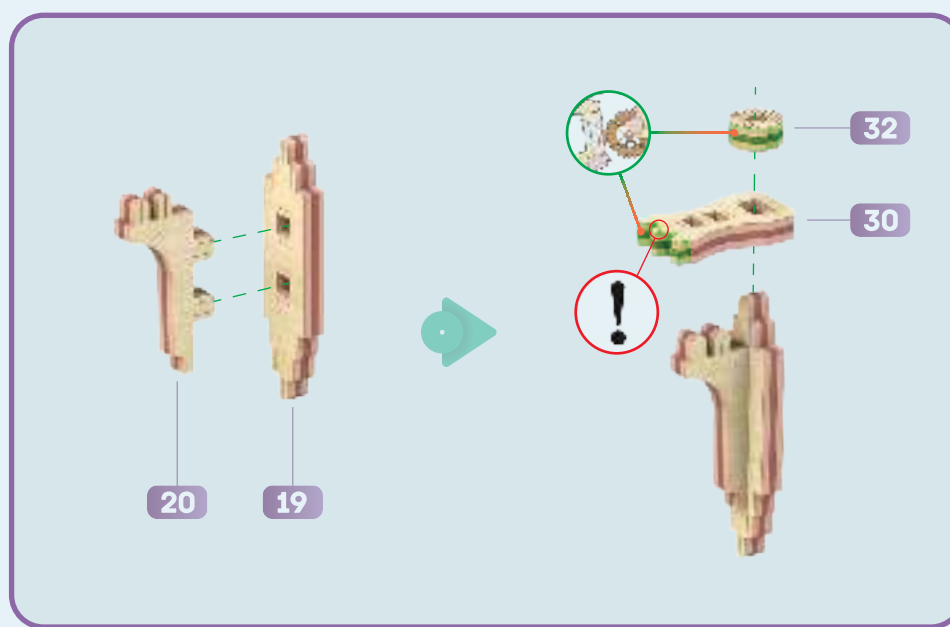

3

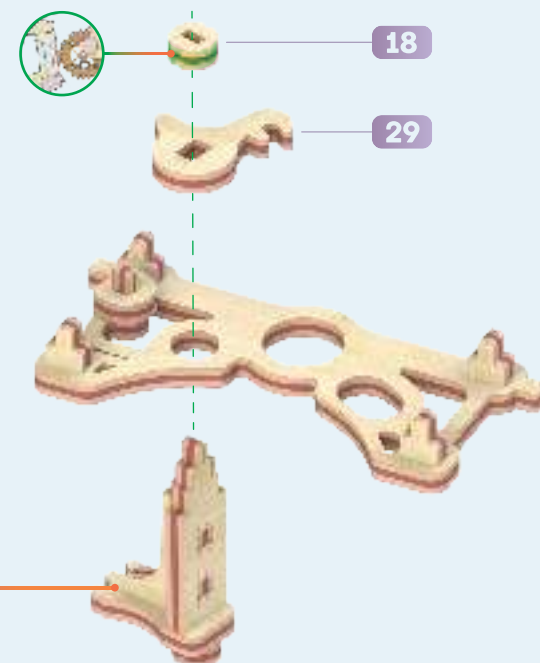

4

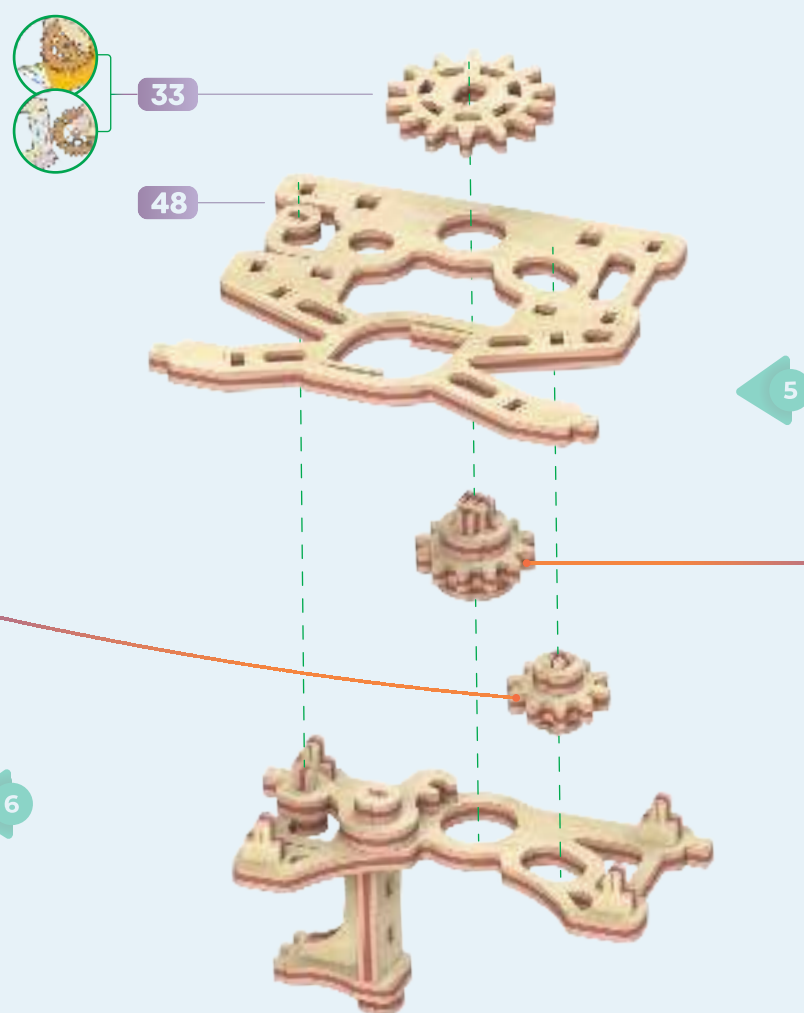
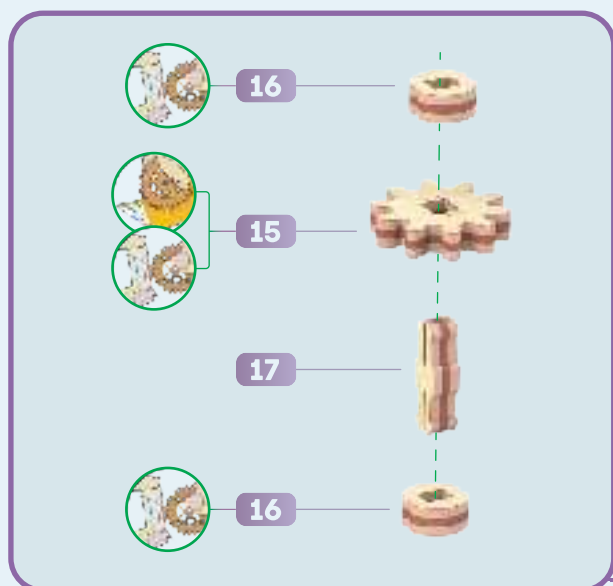

5

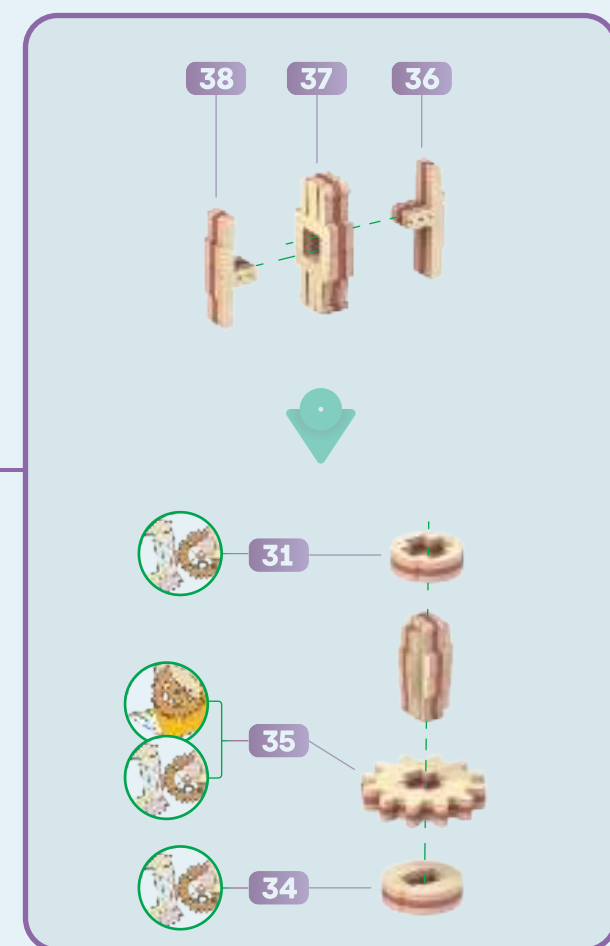

6



6

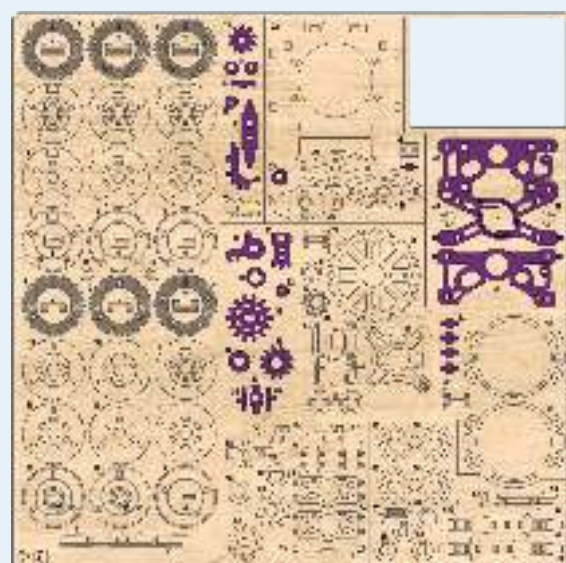

2

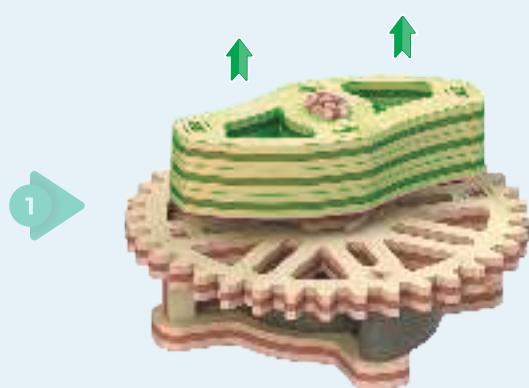

2

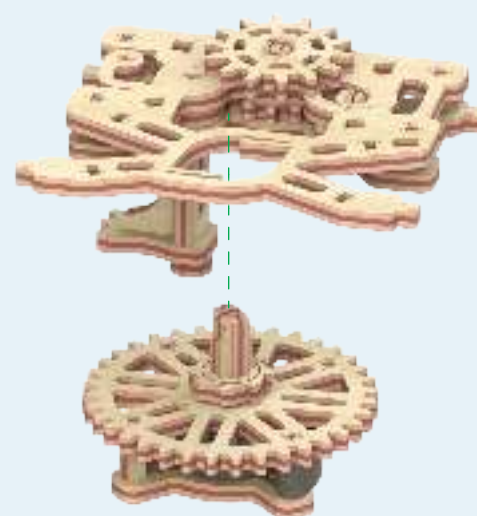

3

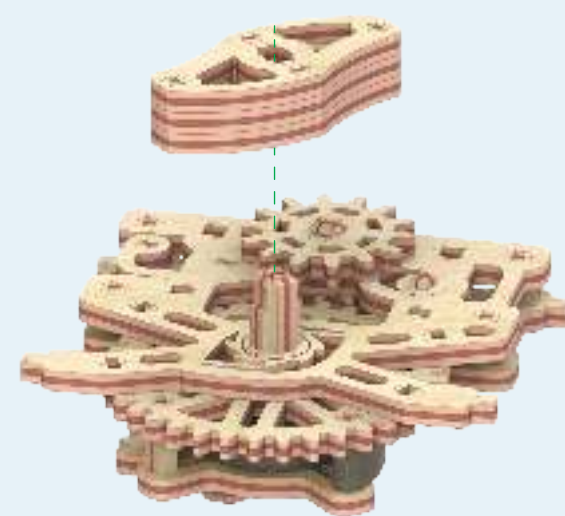

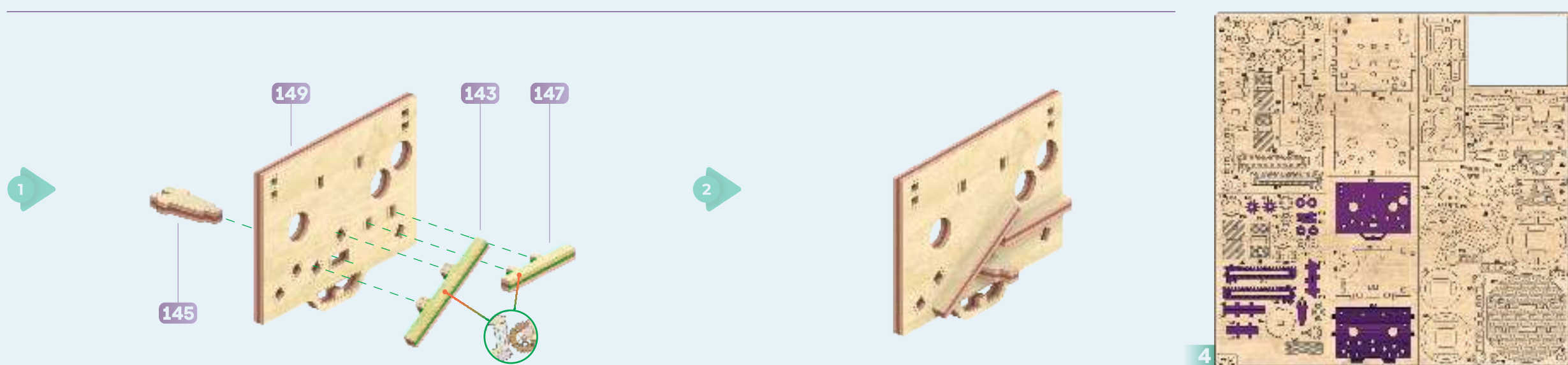
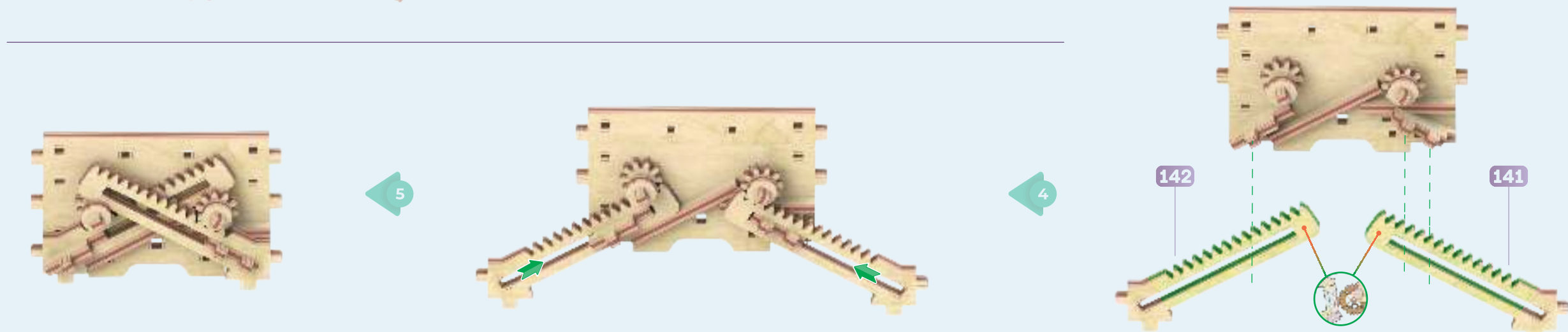
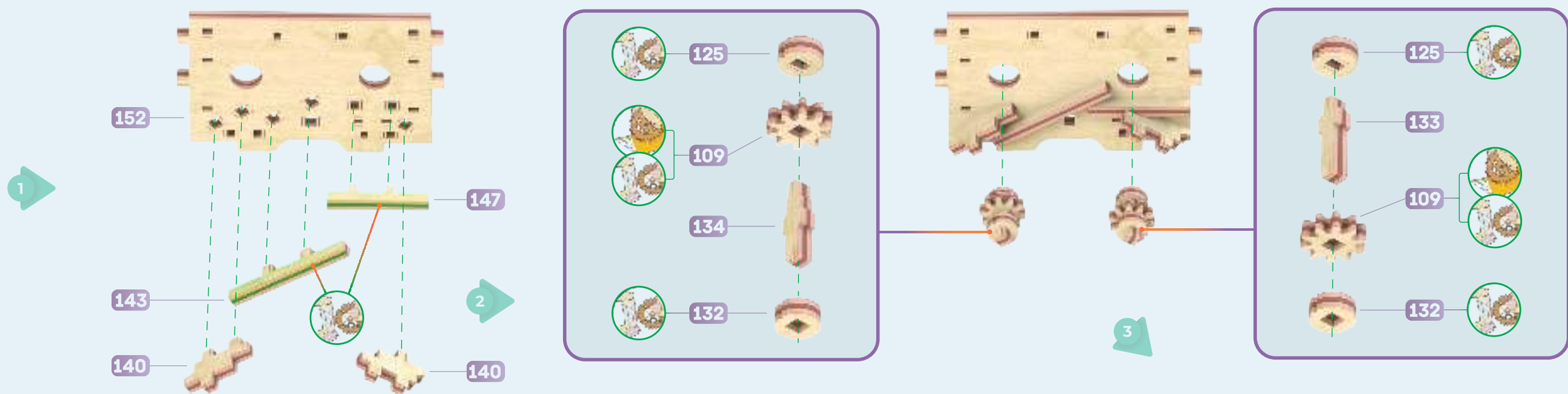
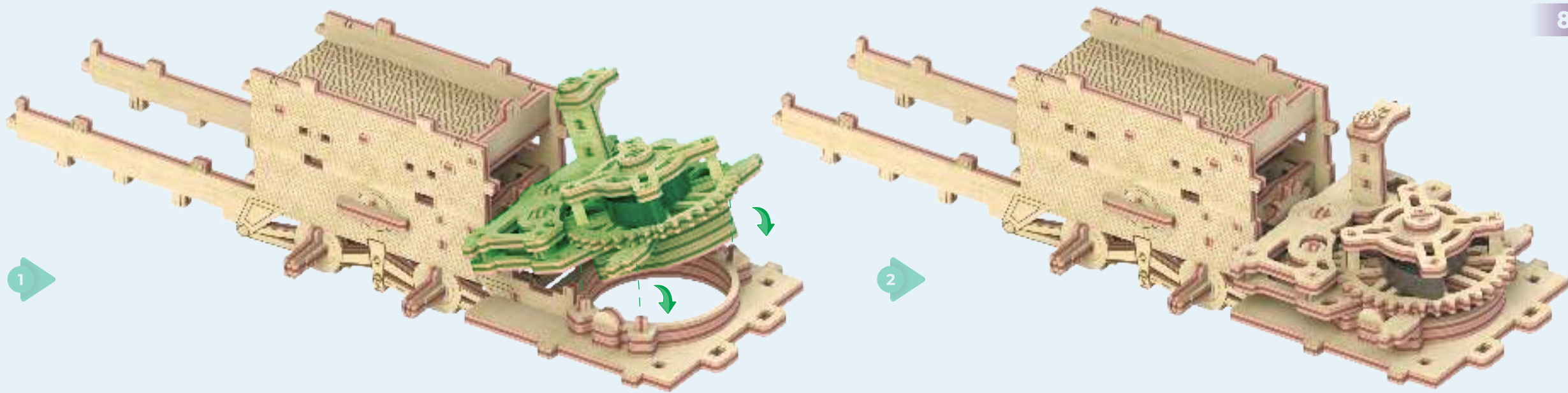

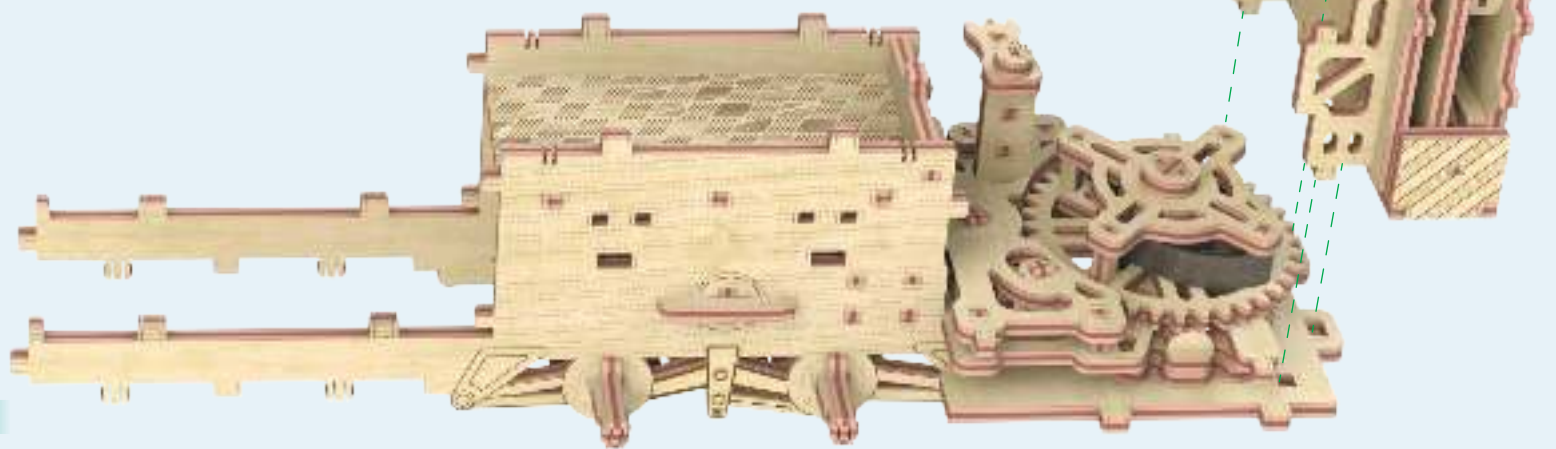
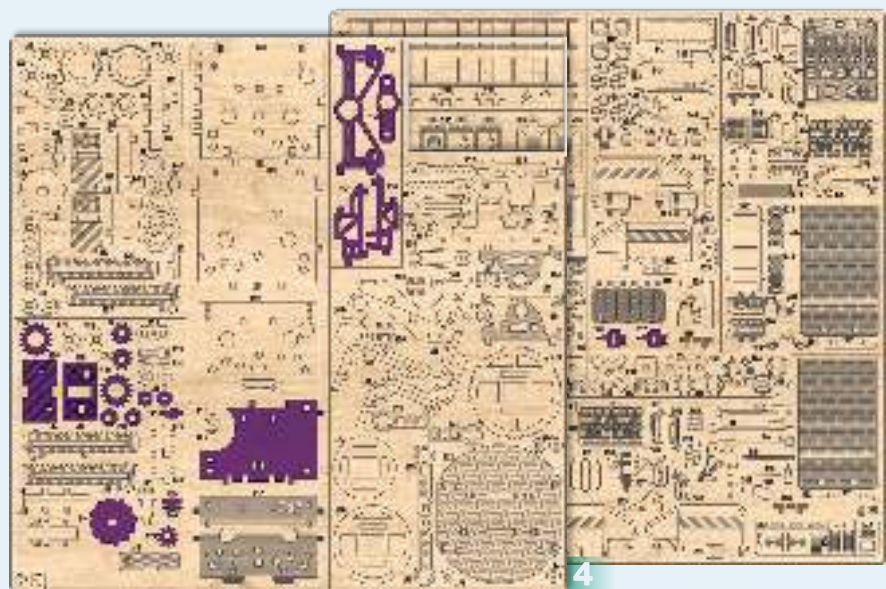
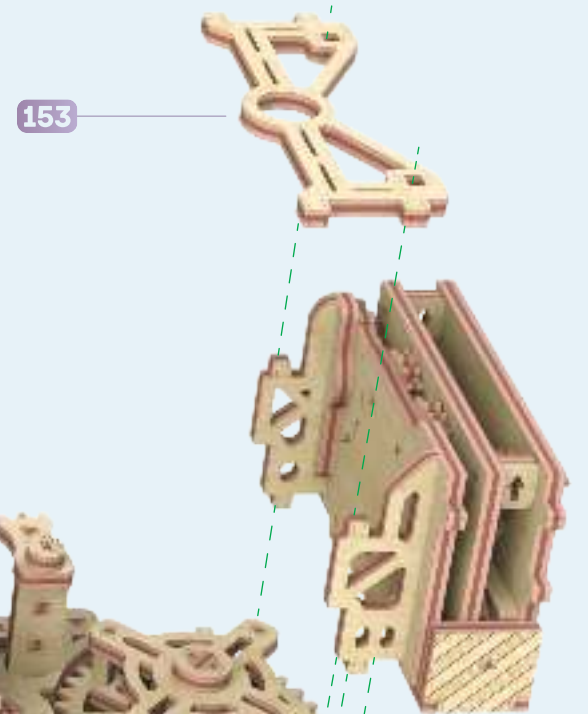
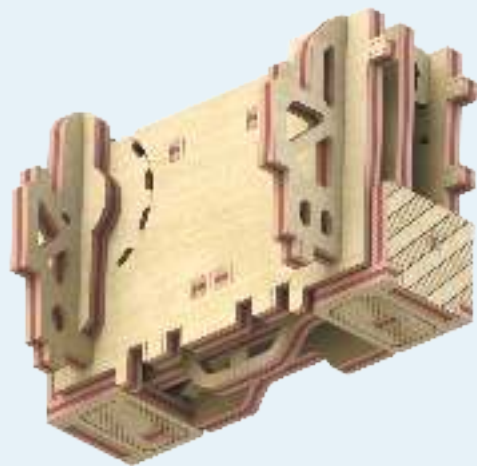
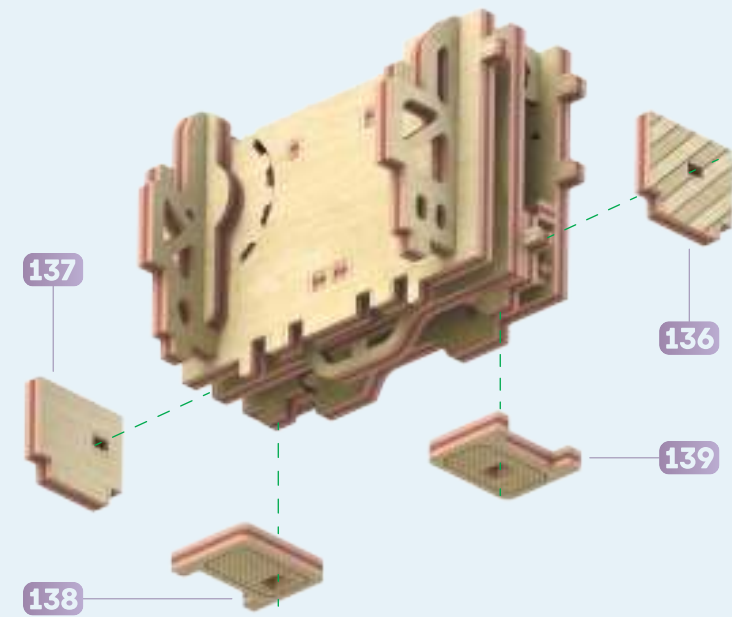
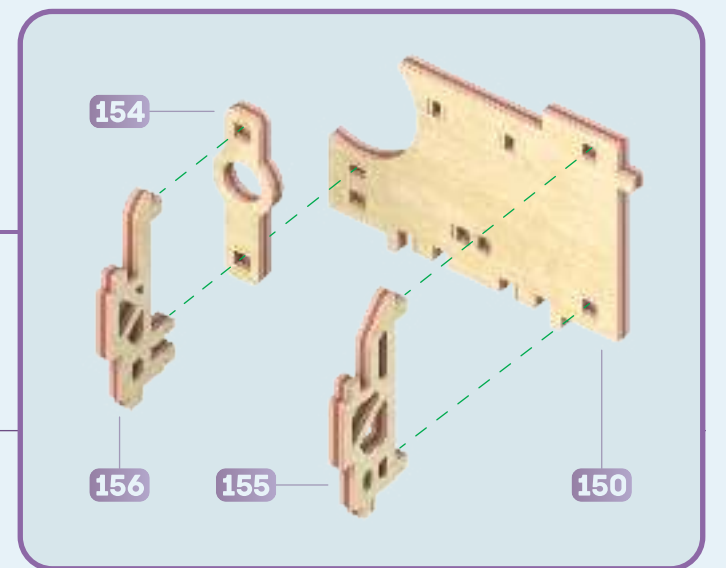
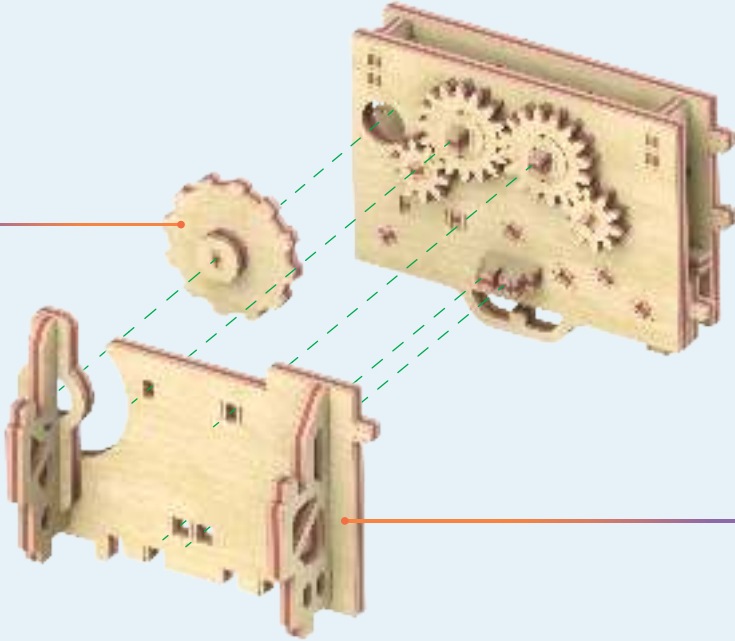
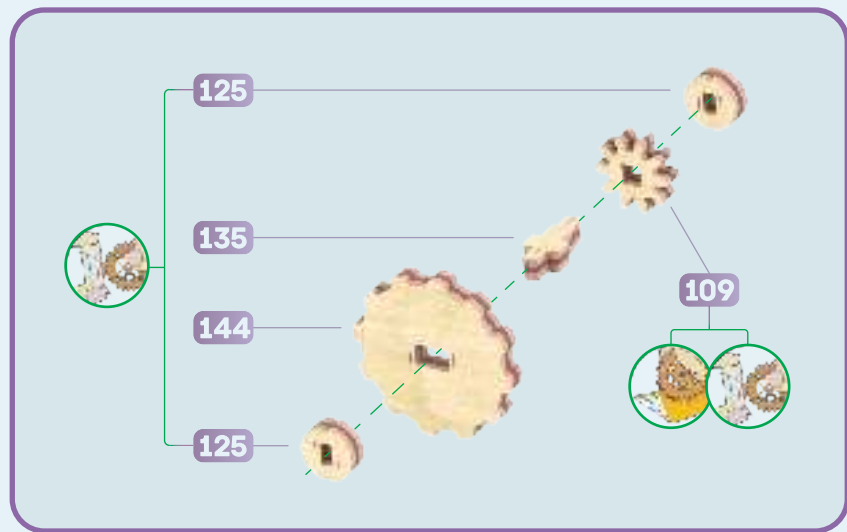
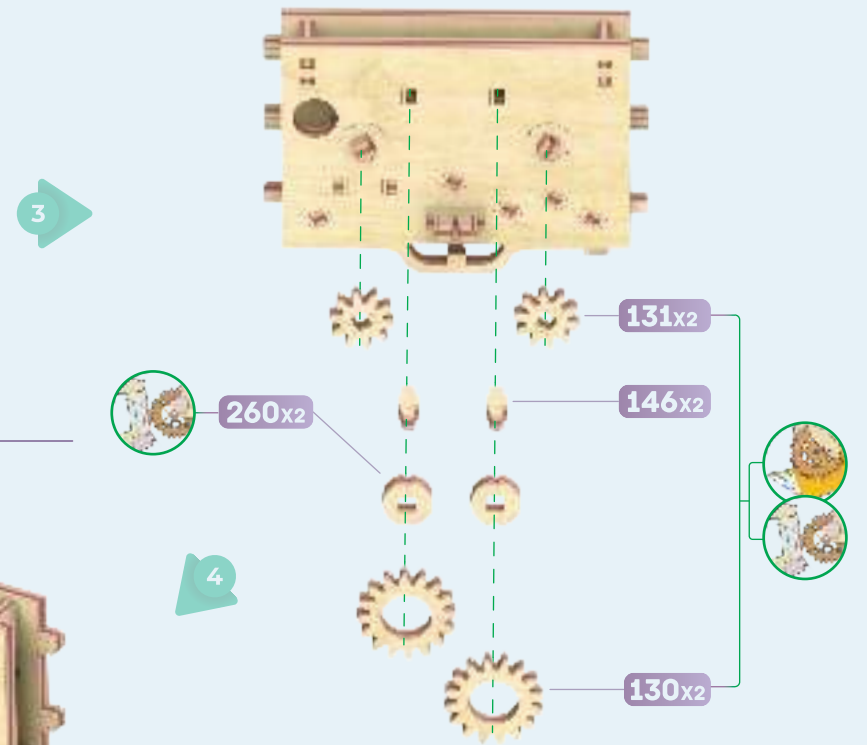
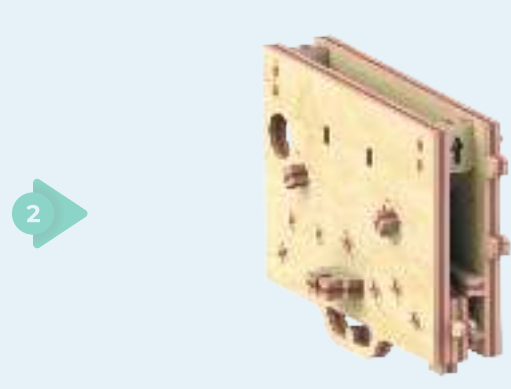
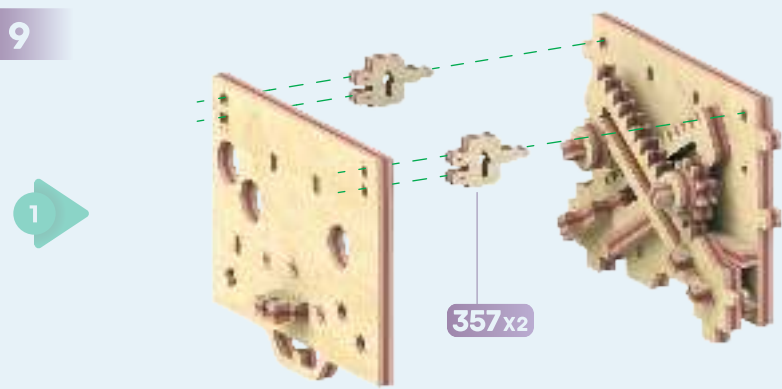

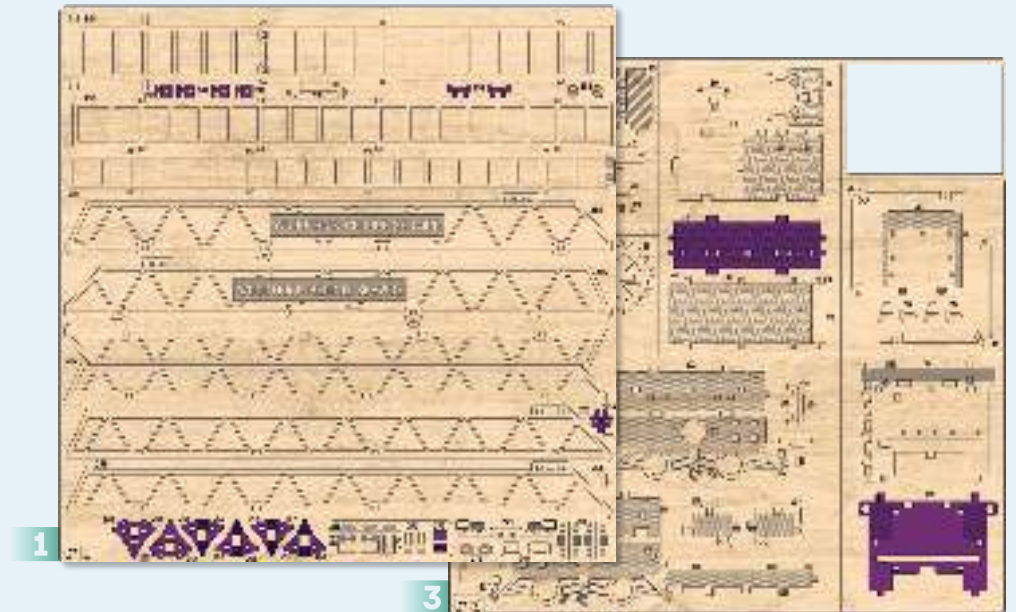
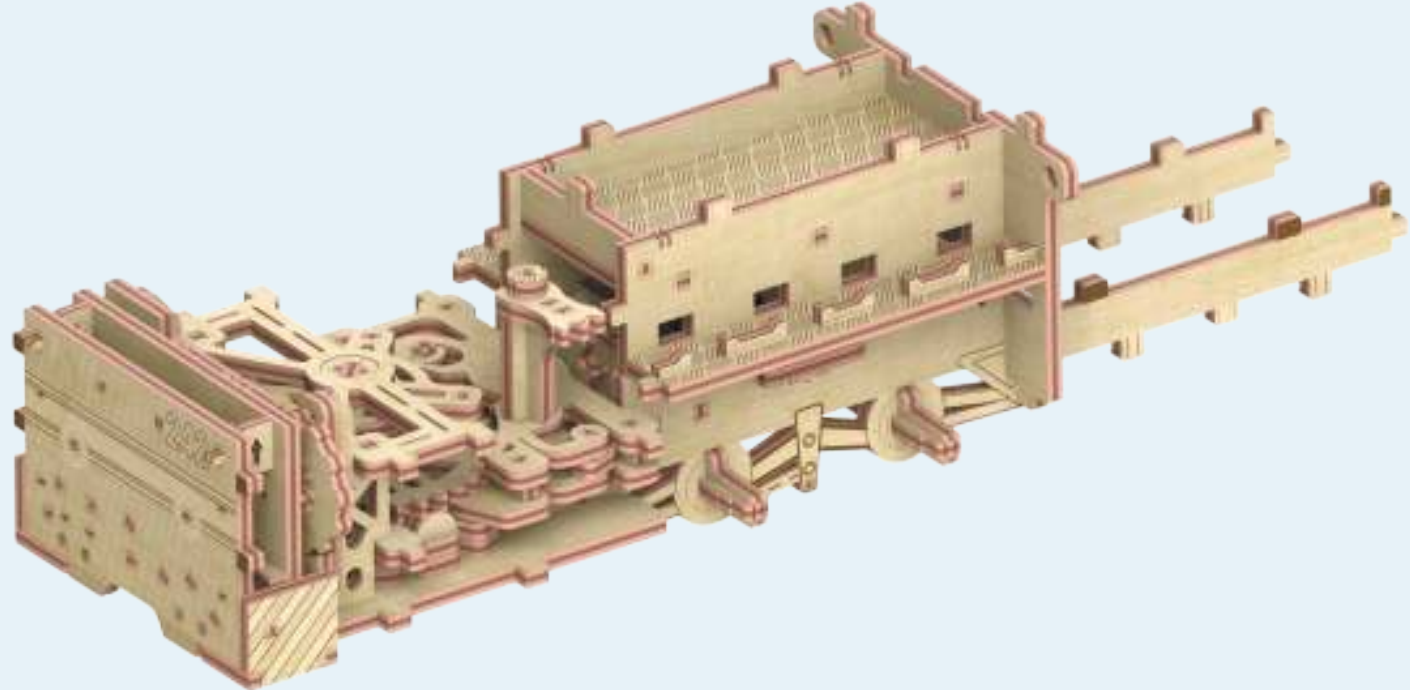
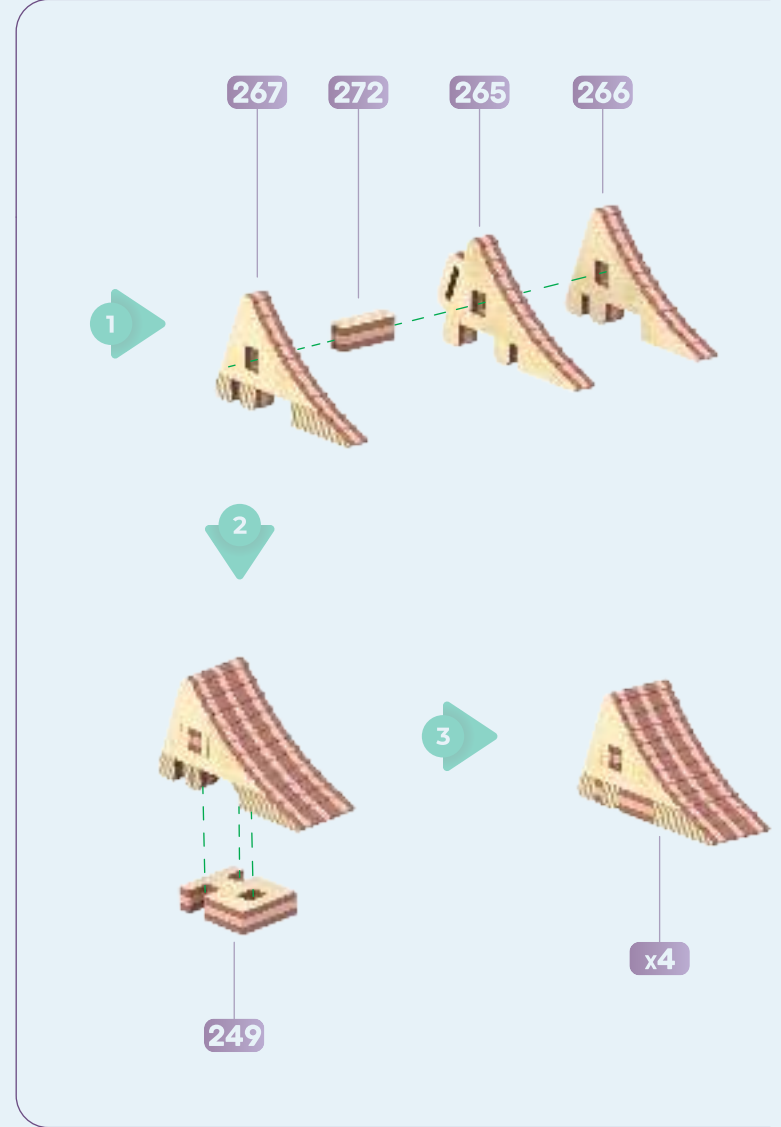
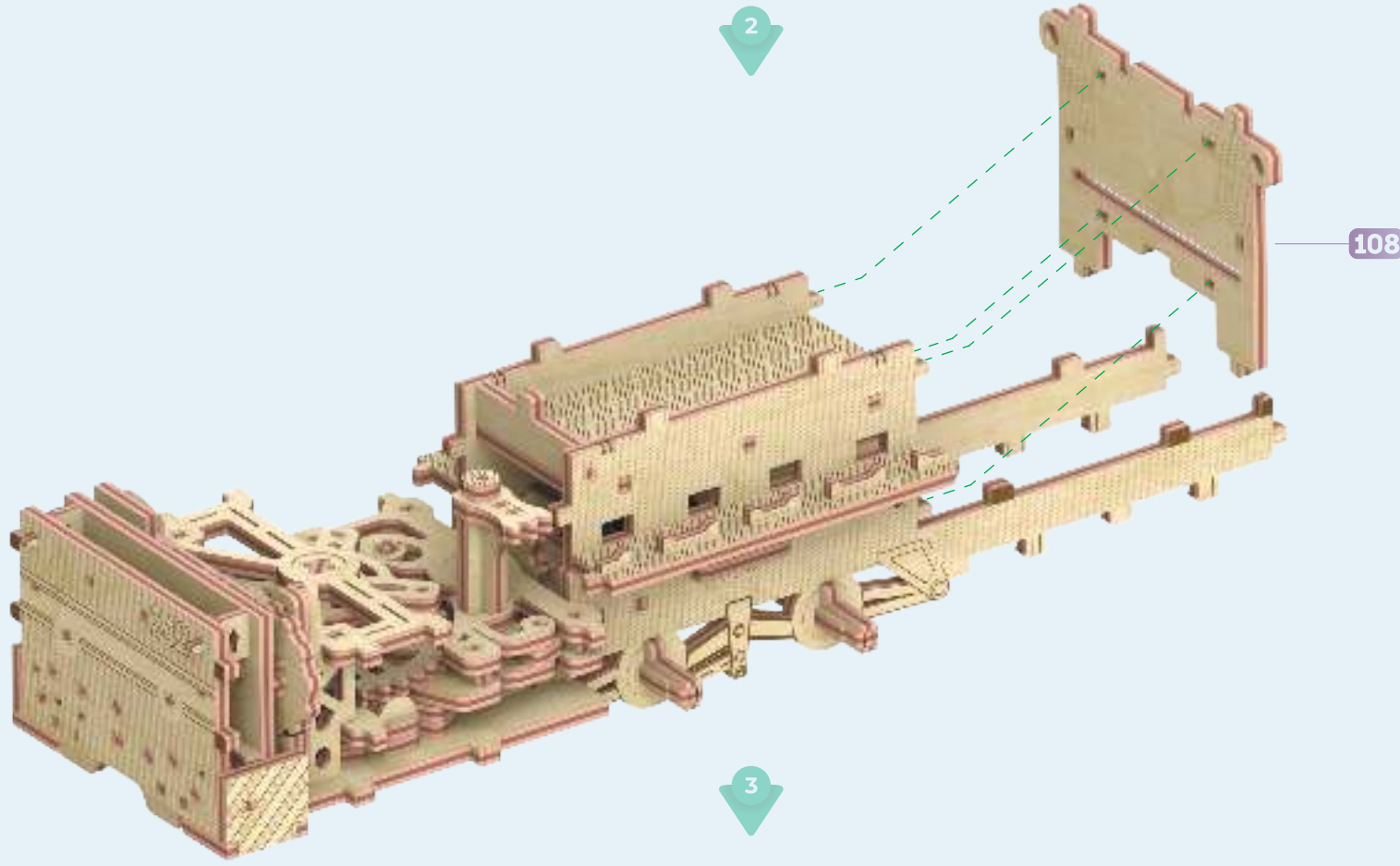
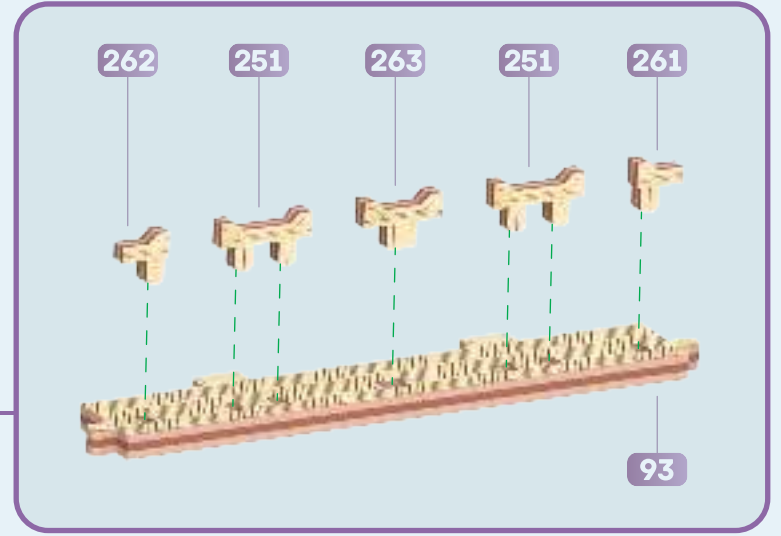
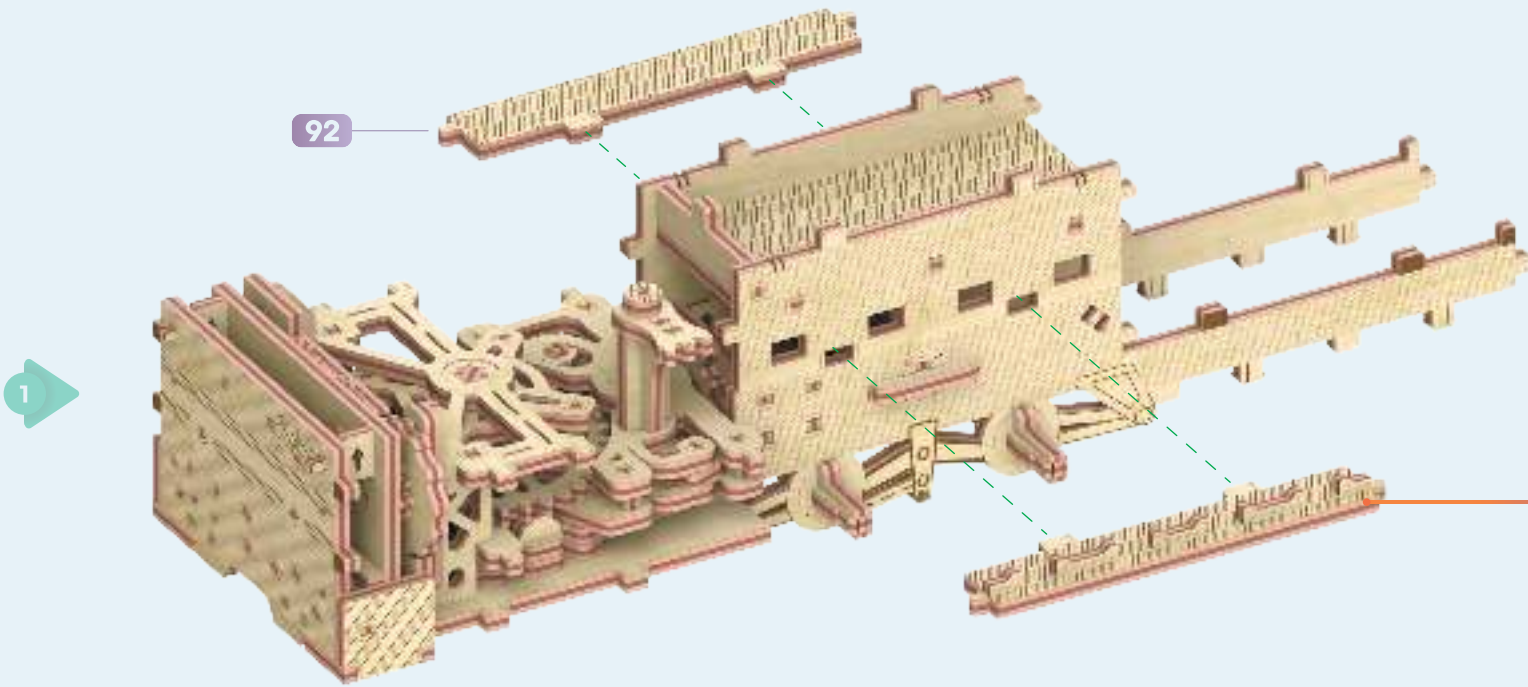

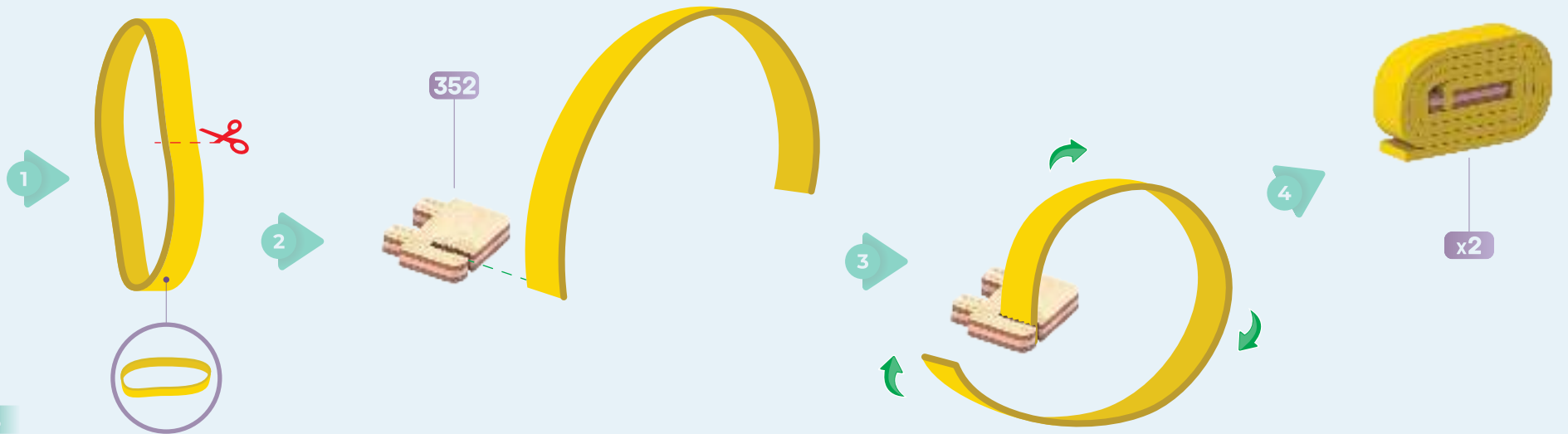
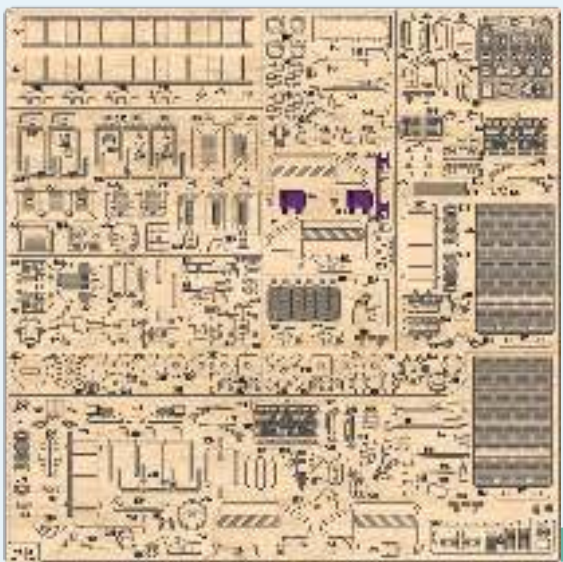
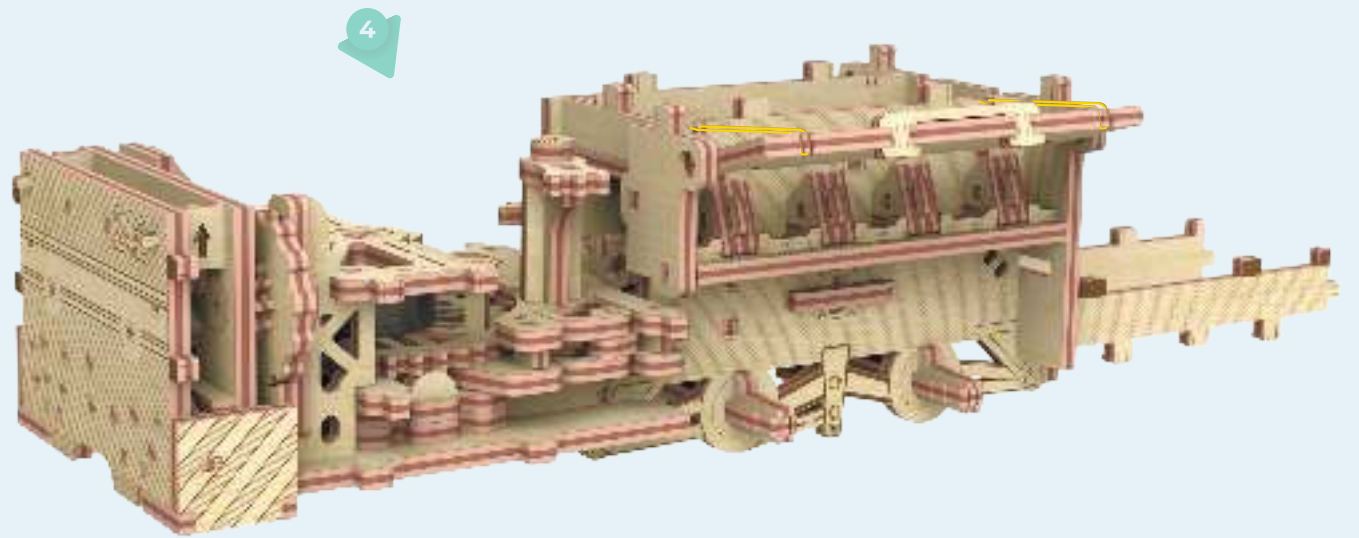
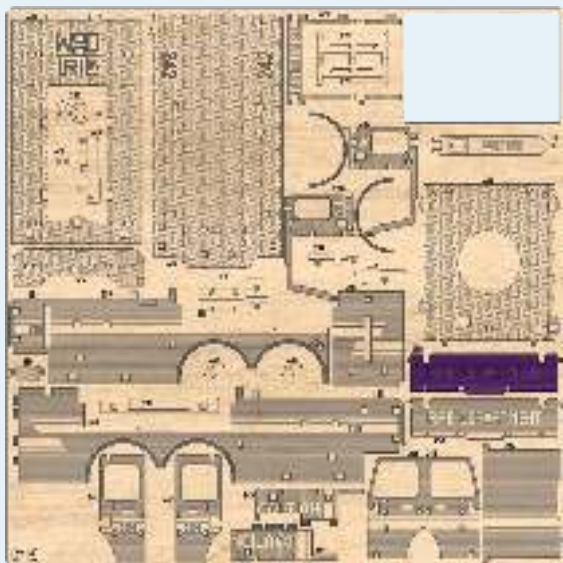
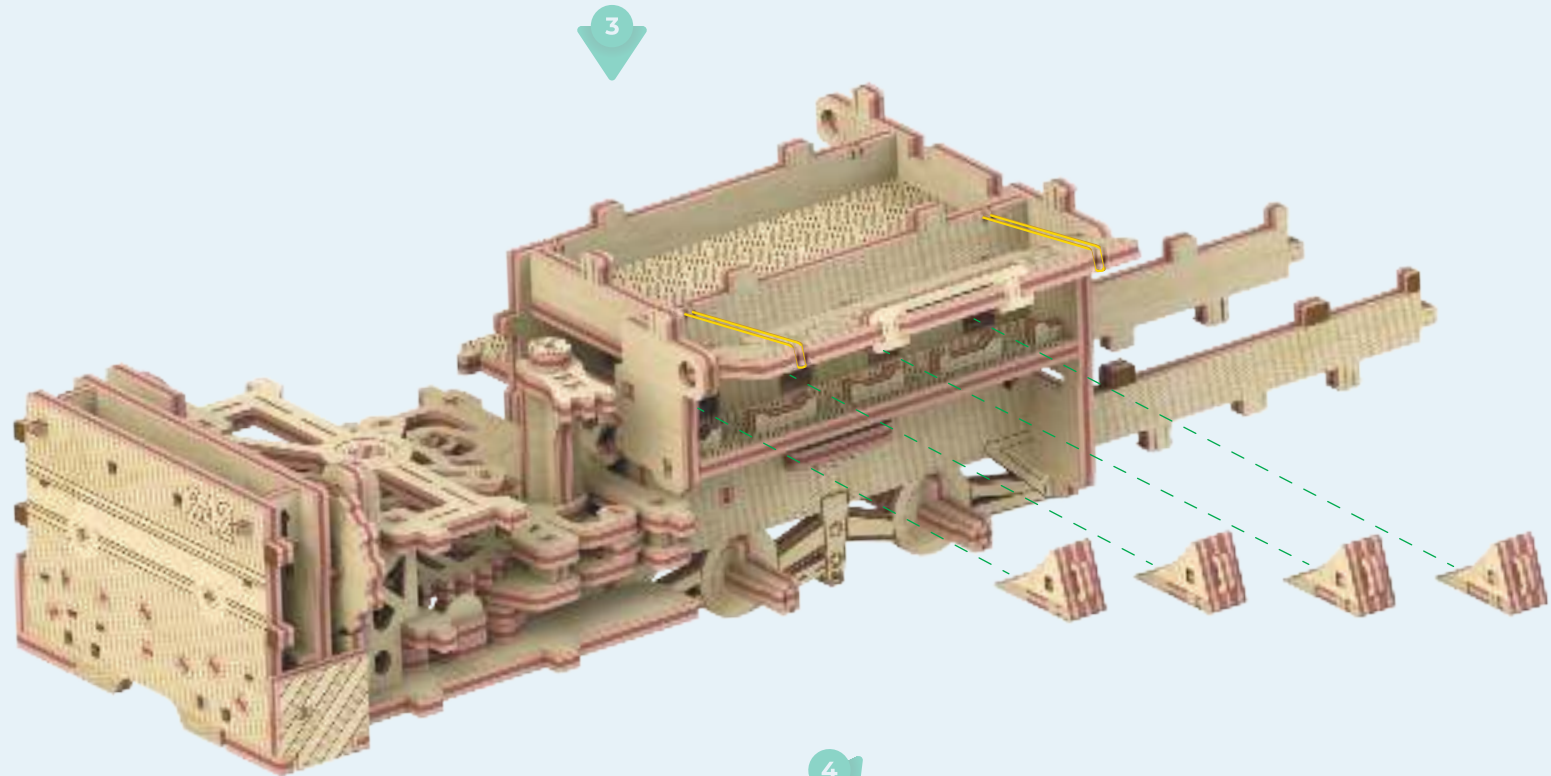
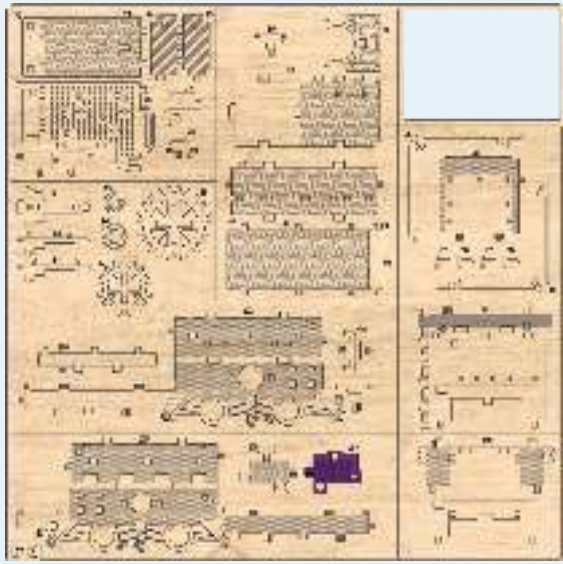
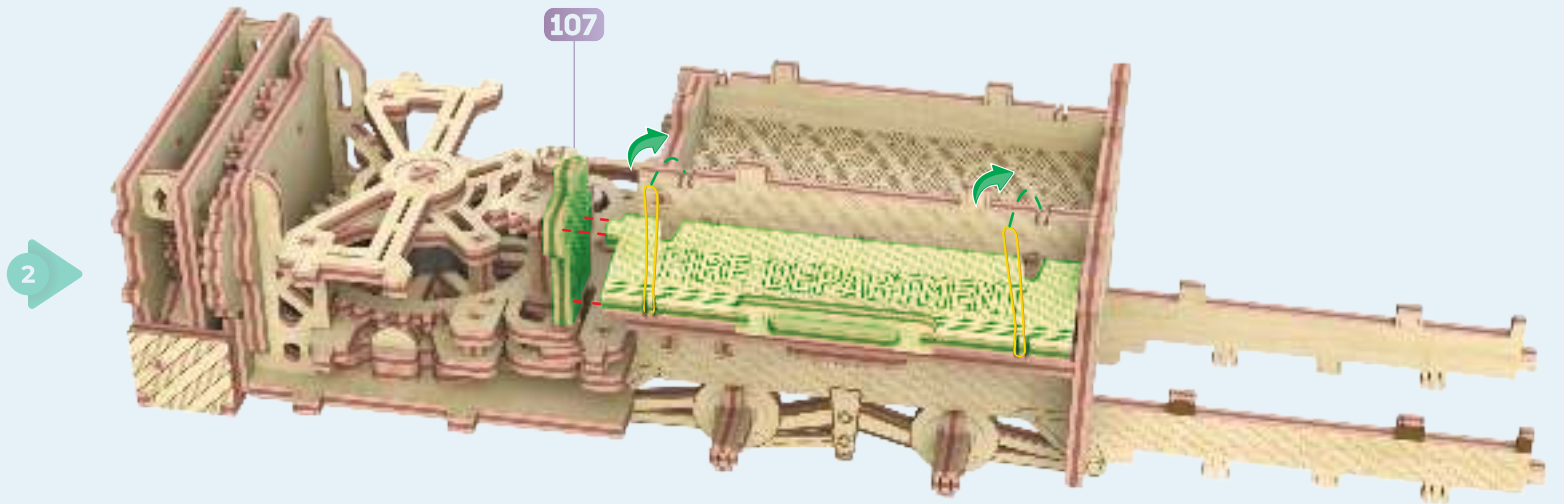
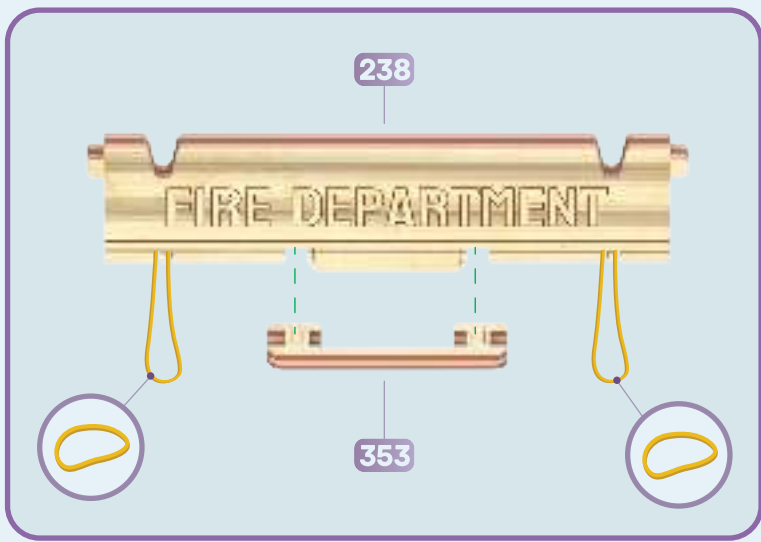

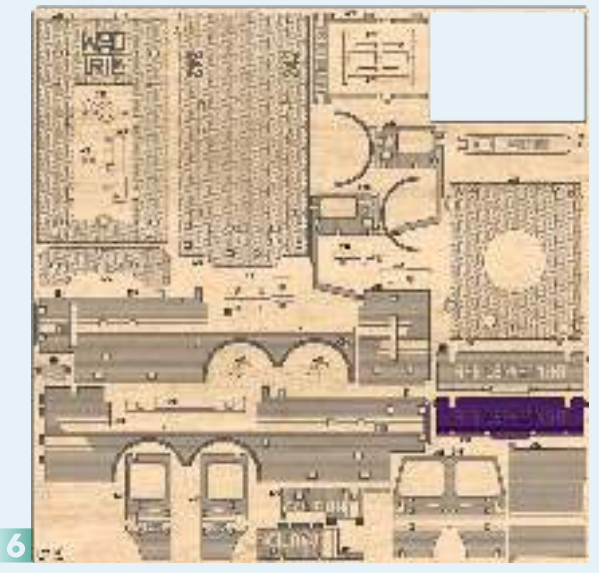
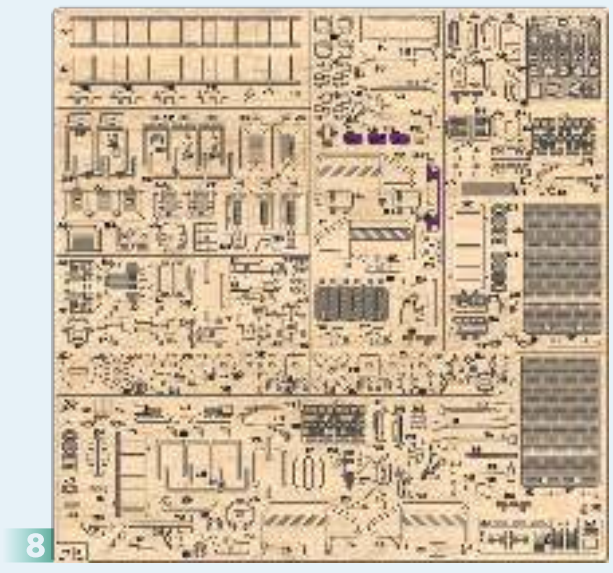
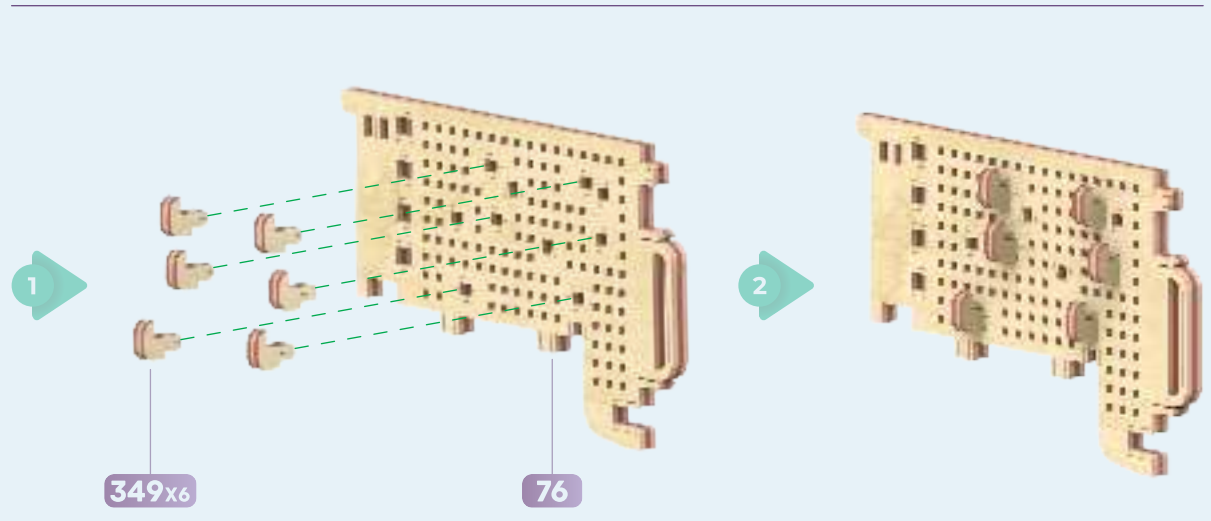
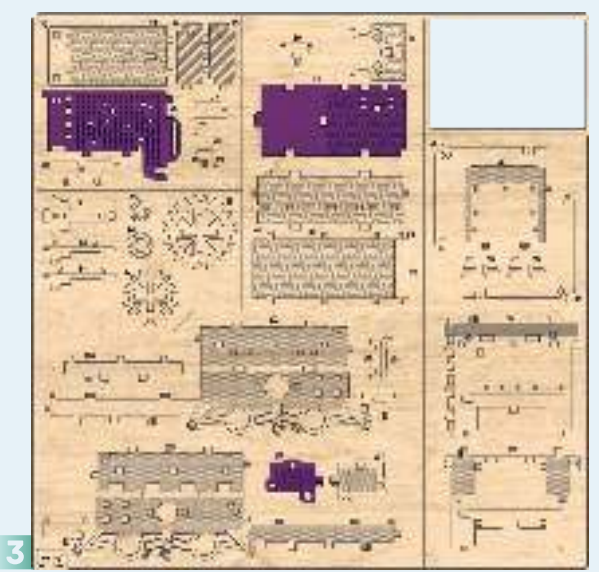
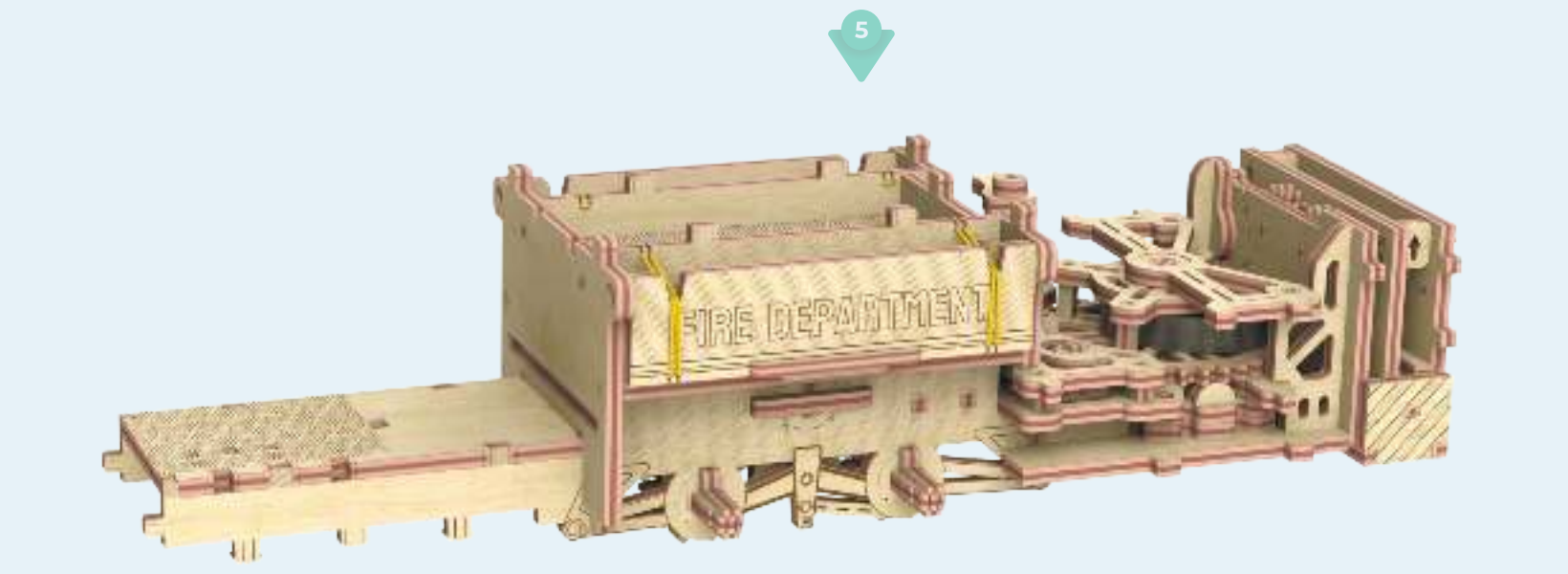
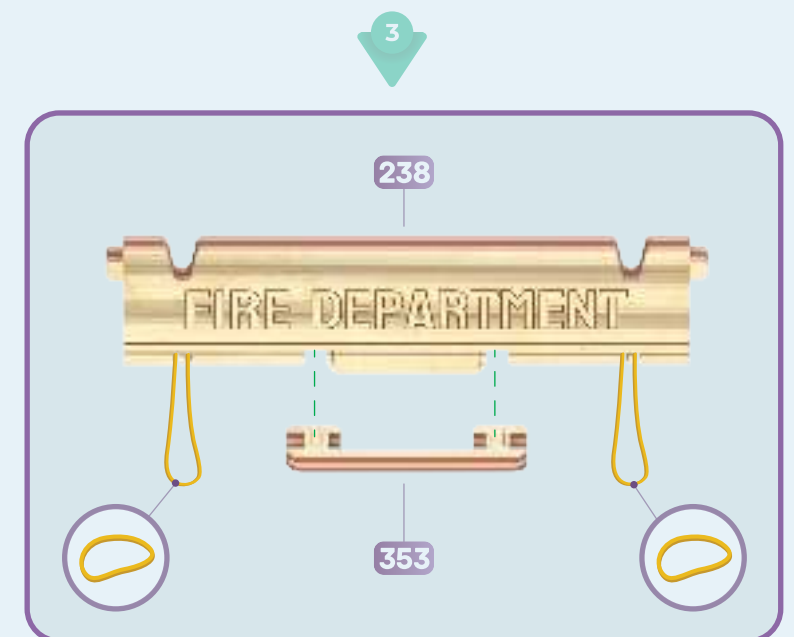
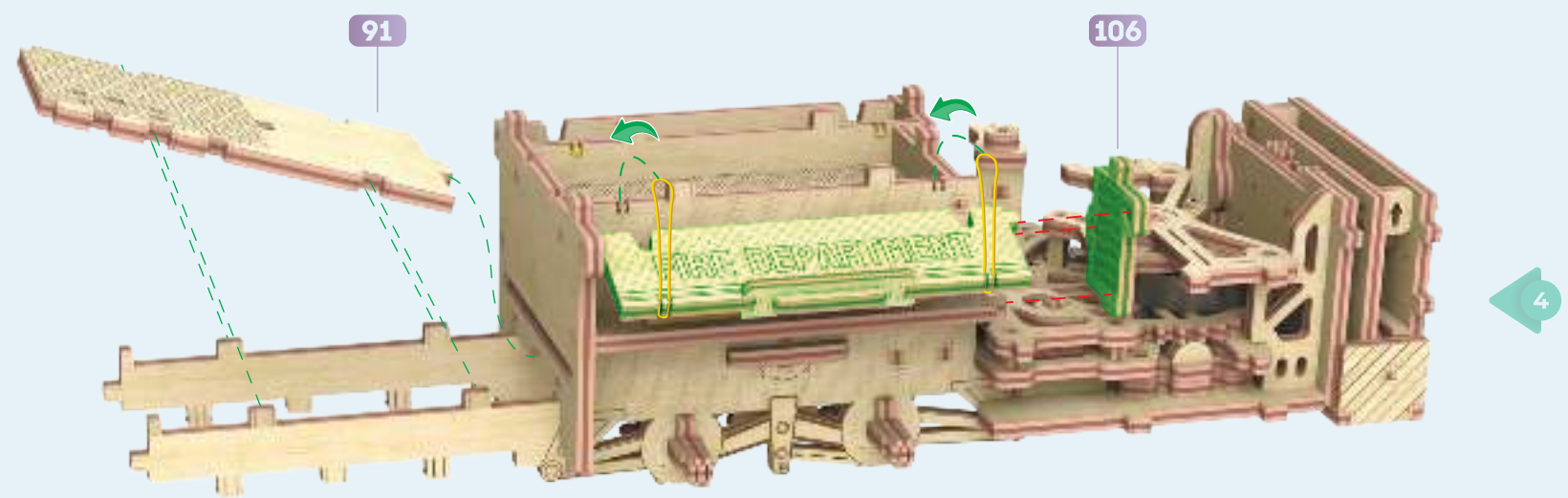
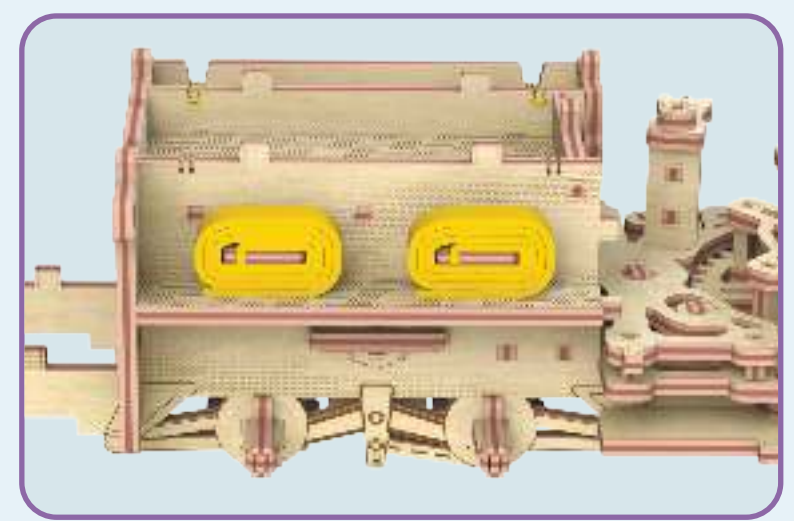
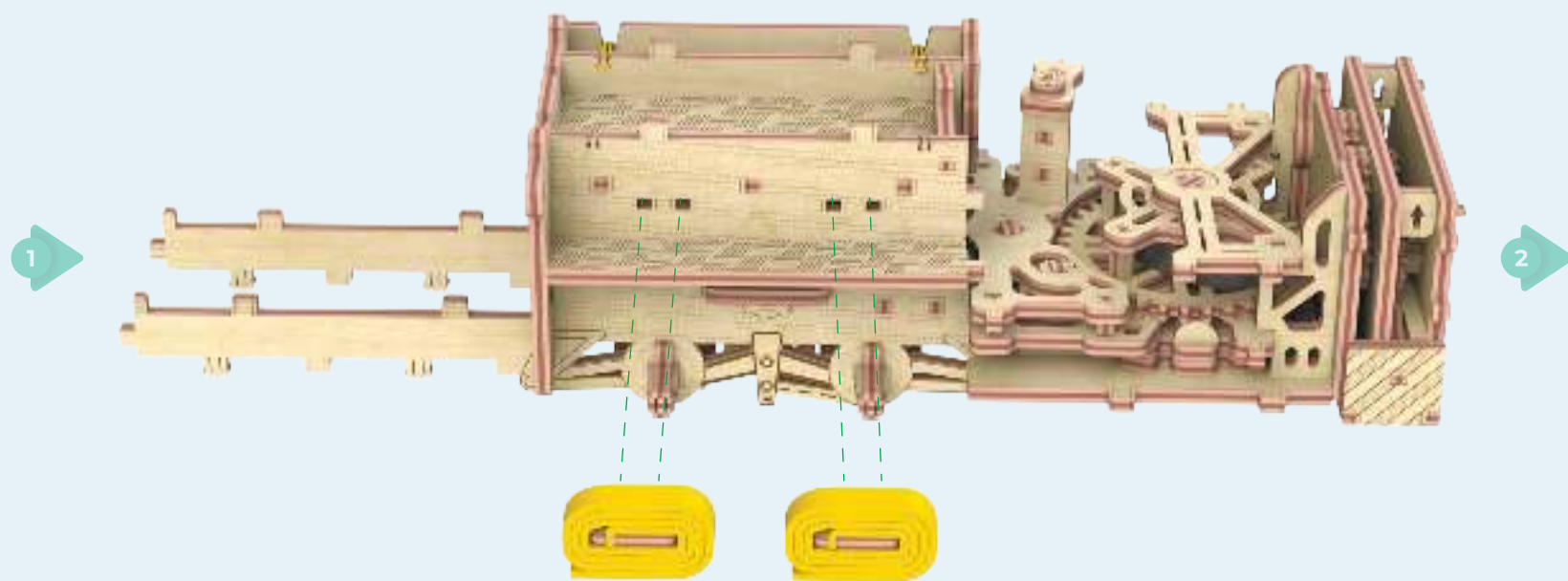

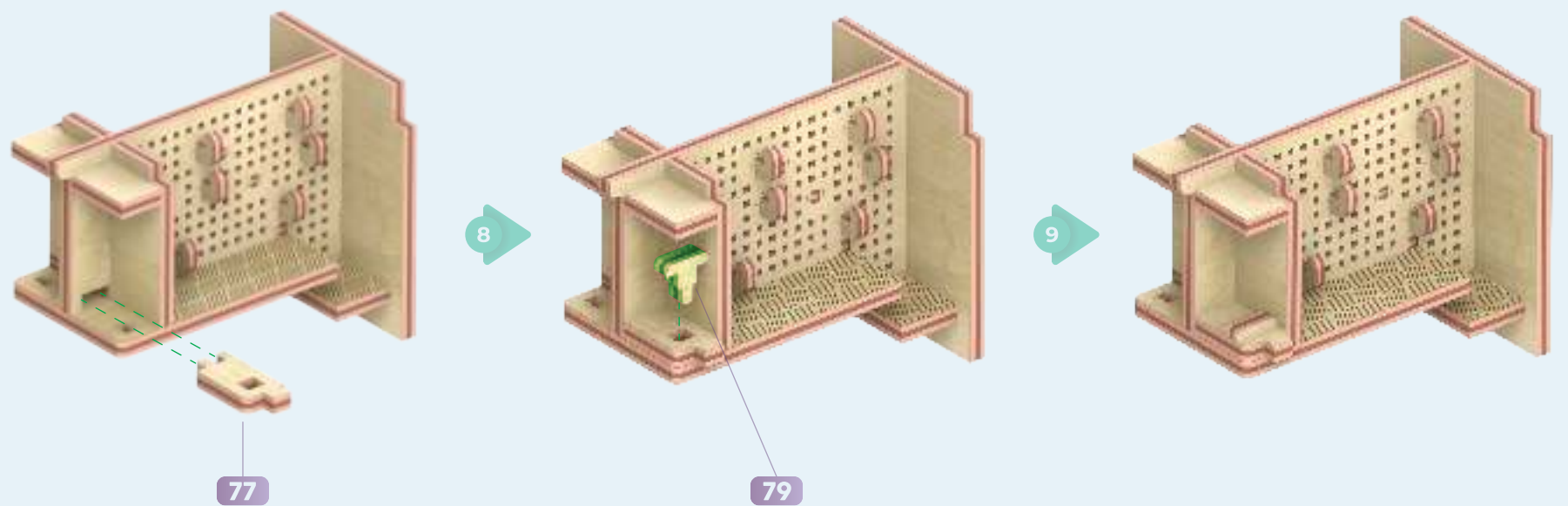
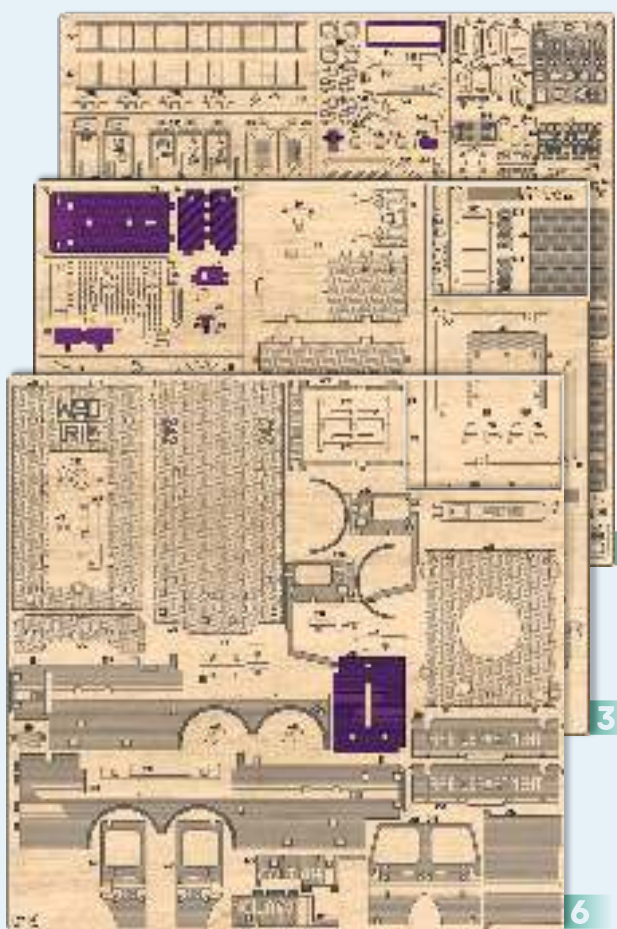
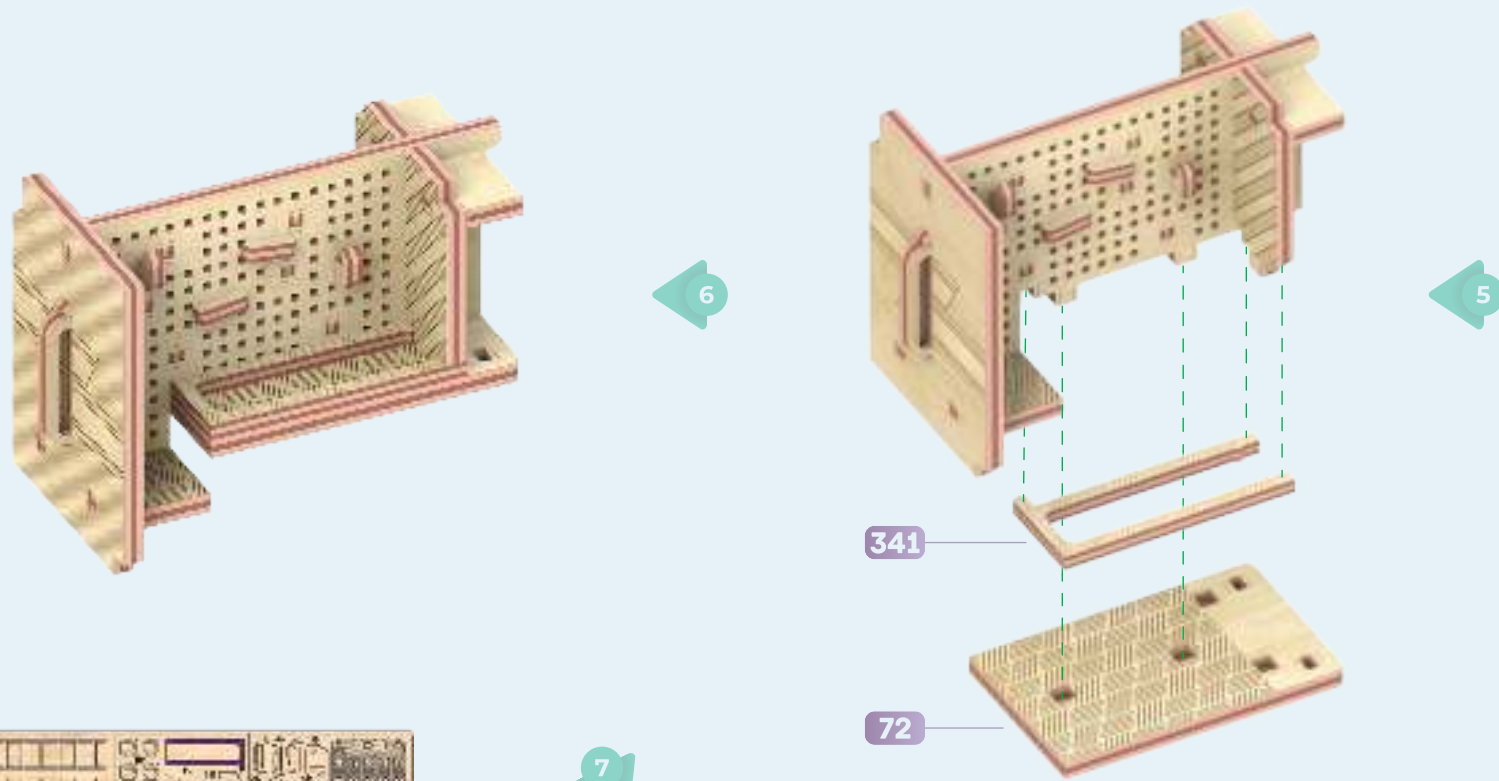
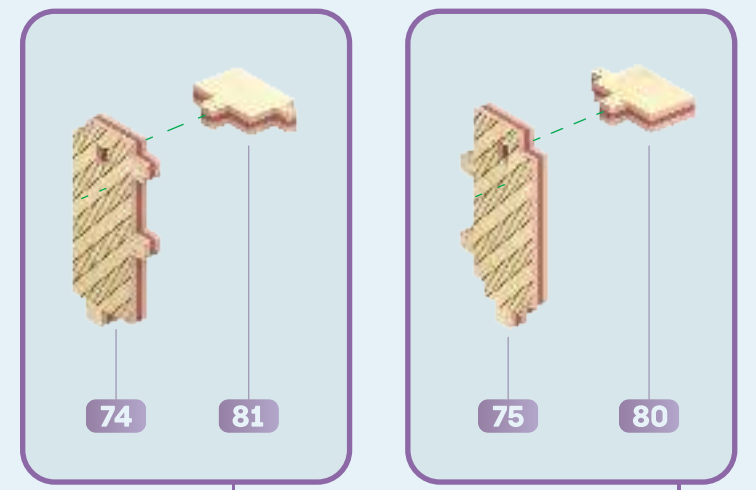
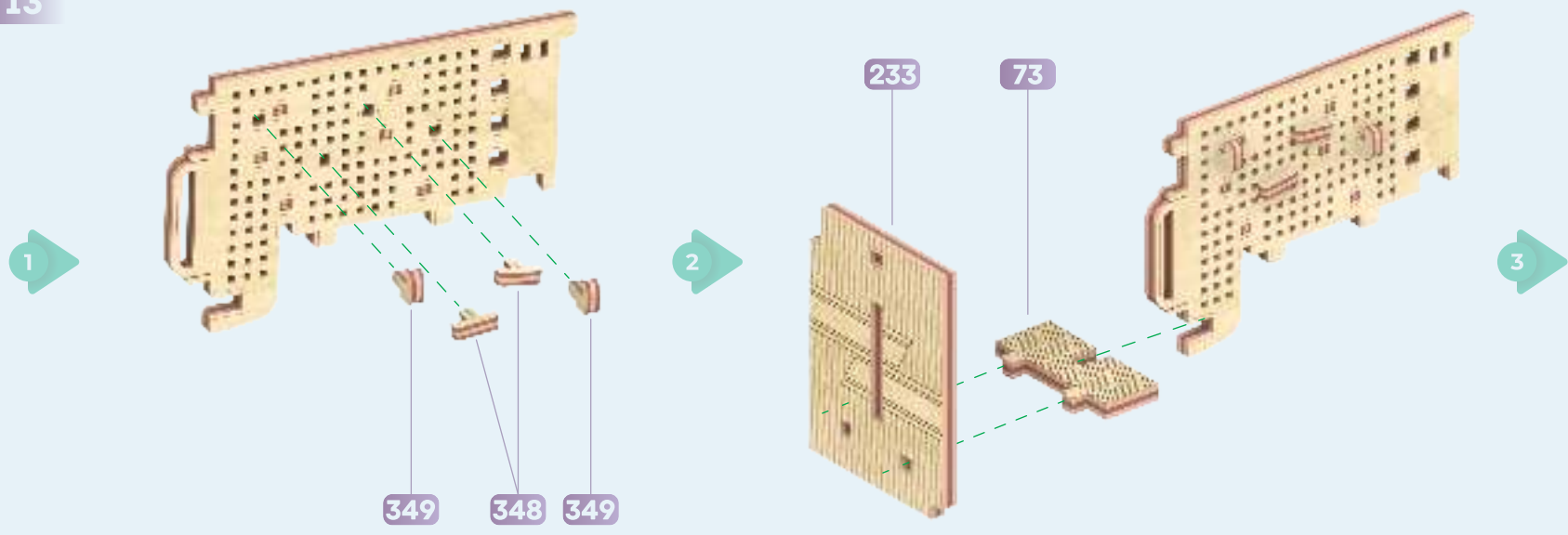

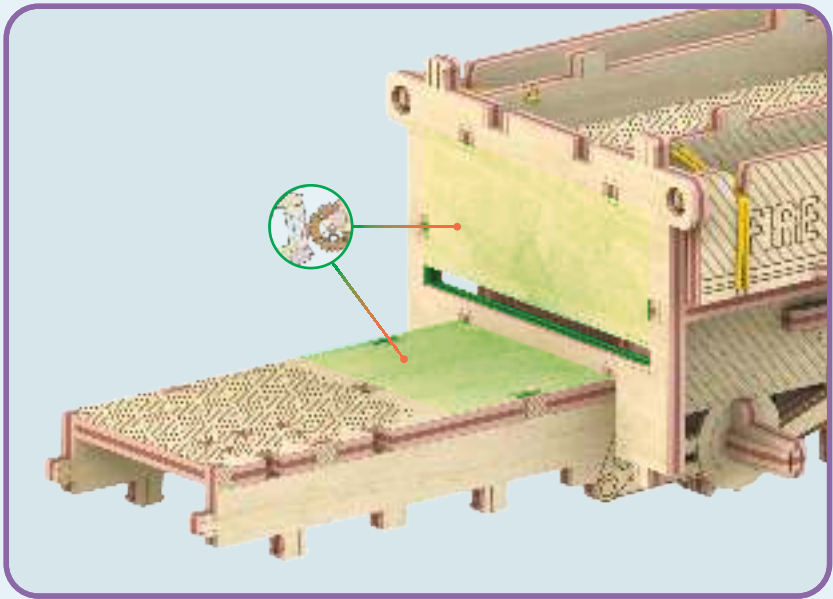

1

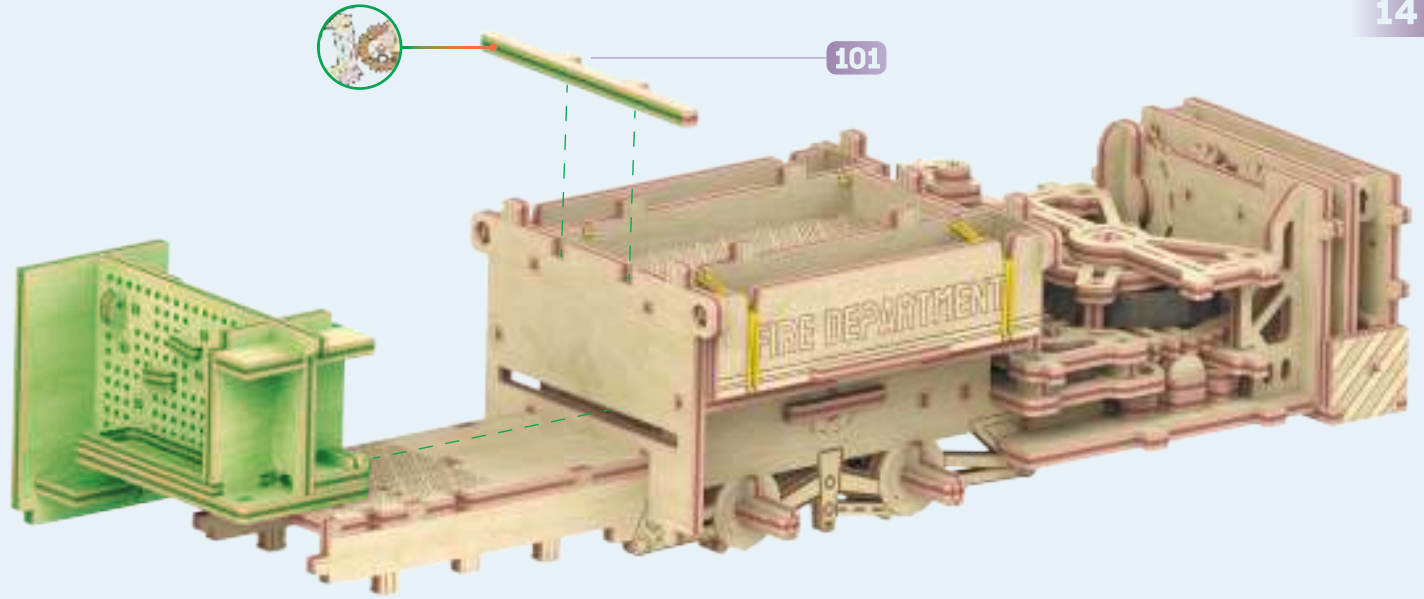

2

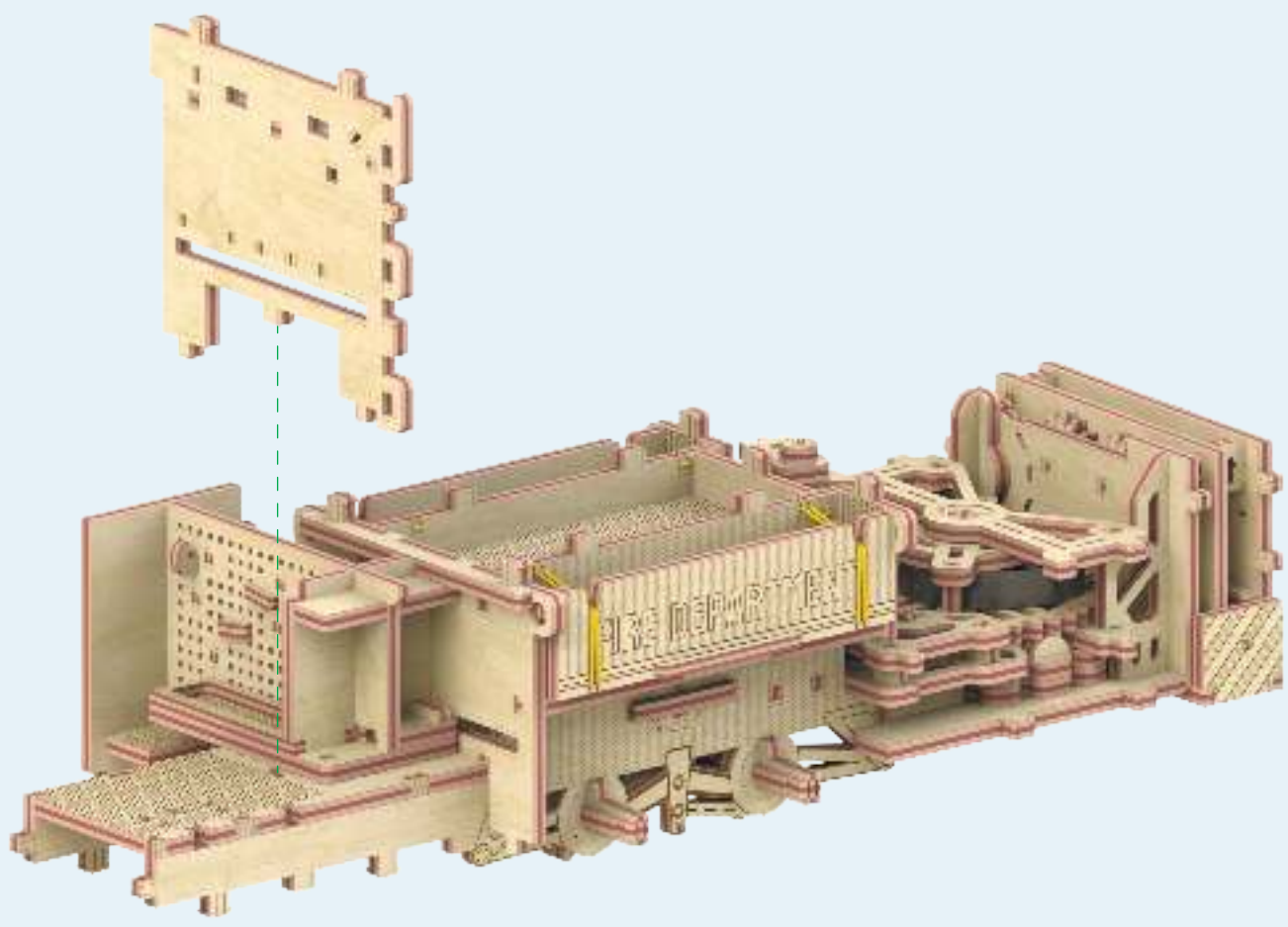

3

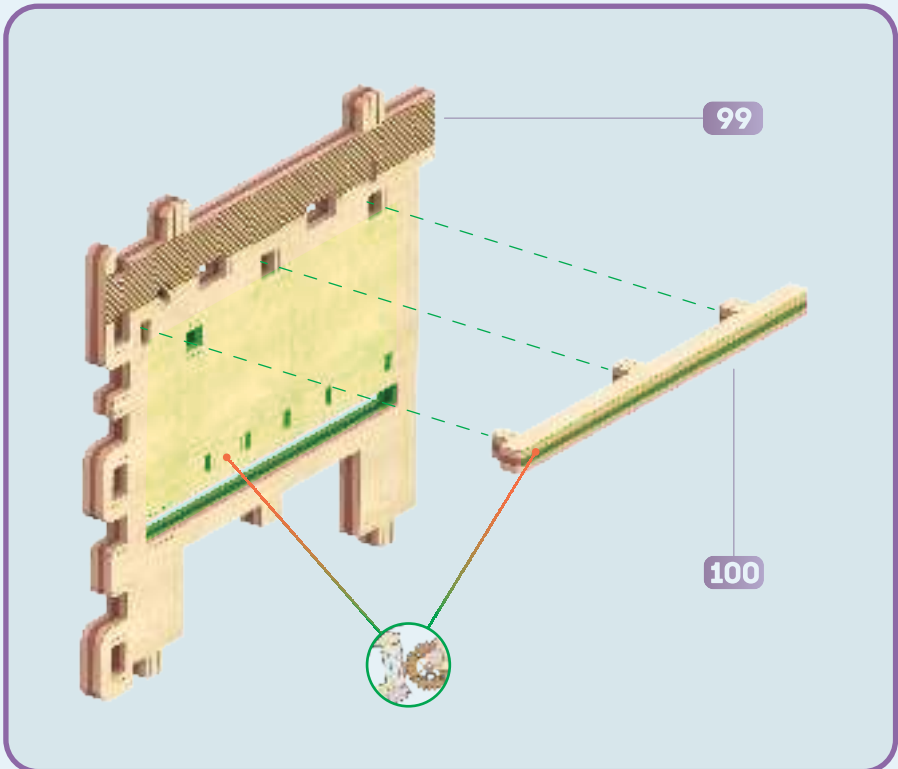

4

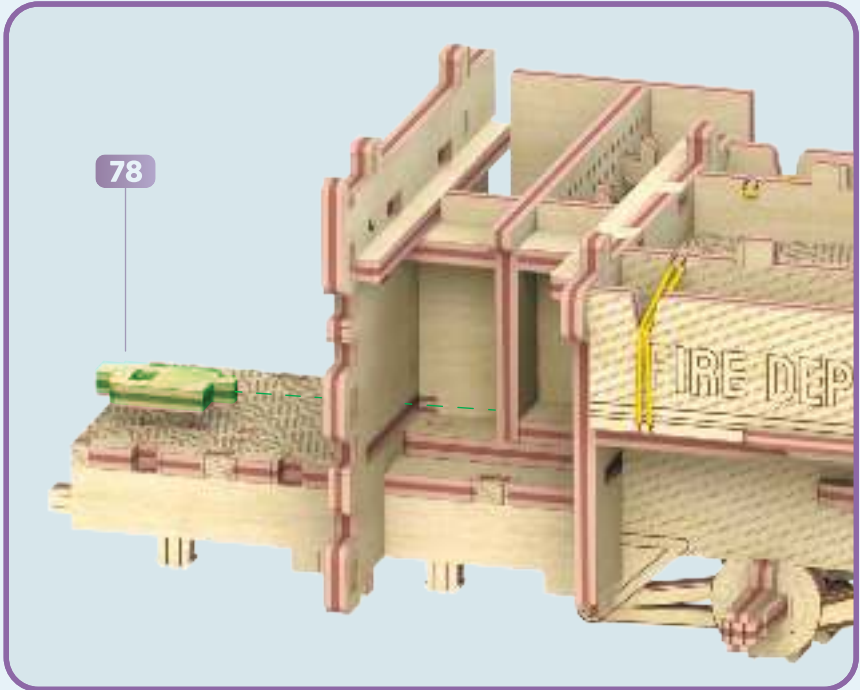

5

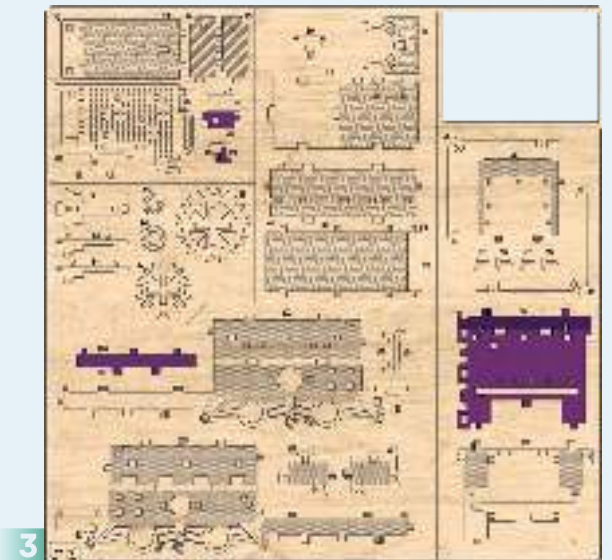
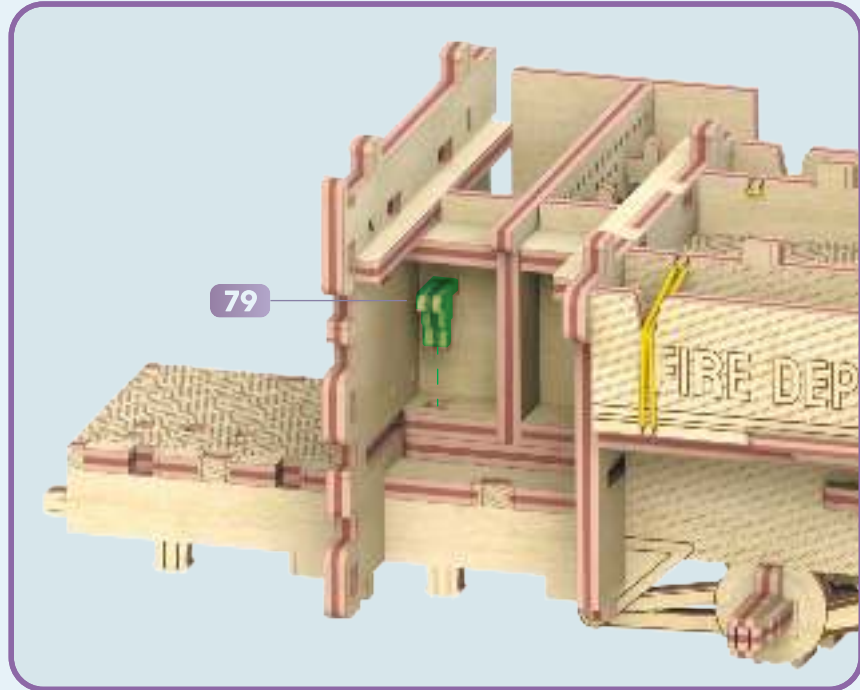

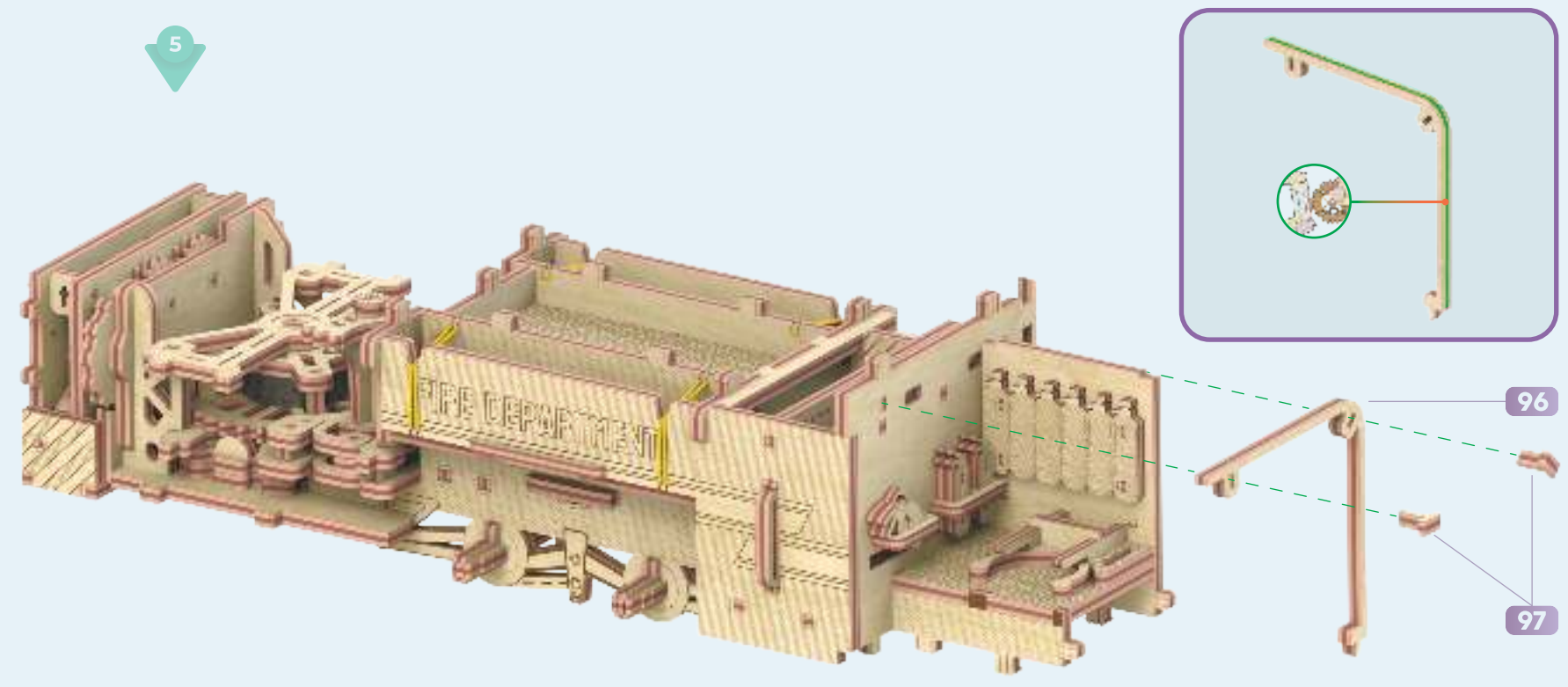
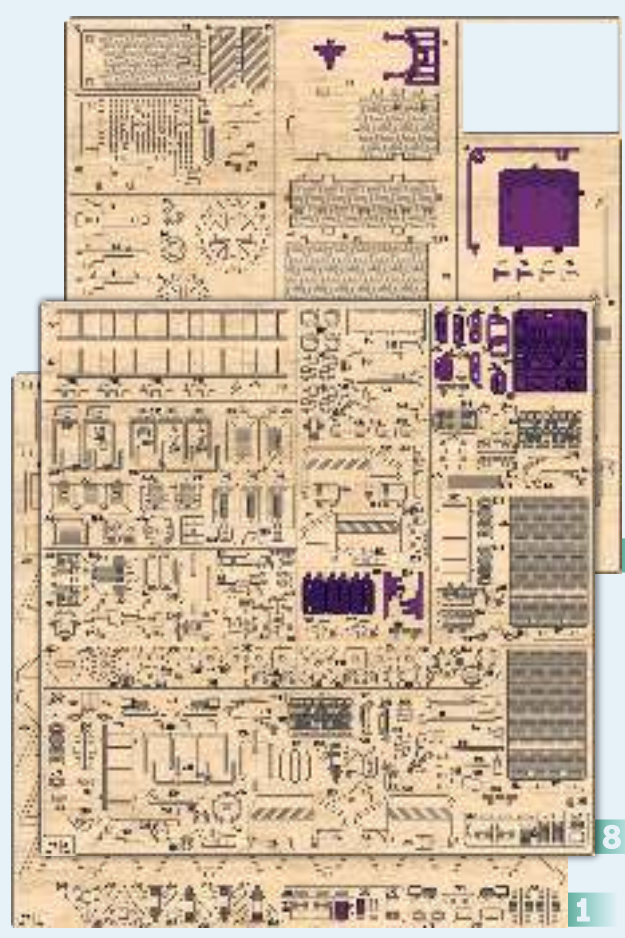
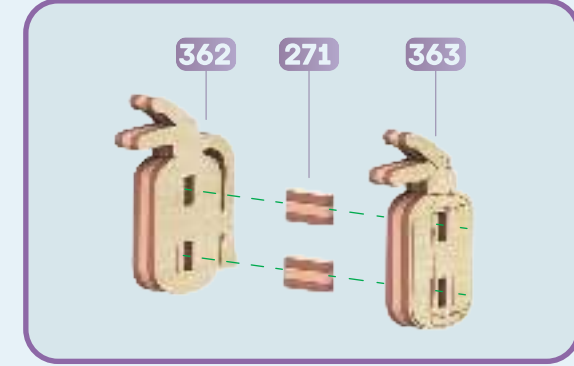
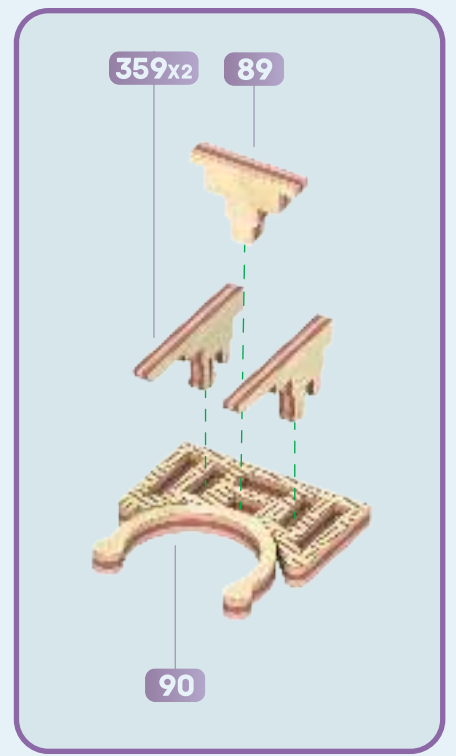
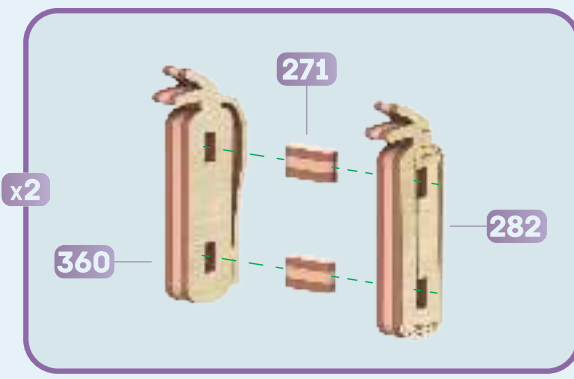
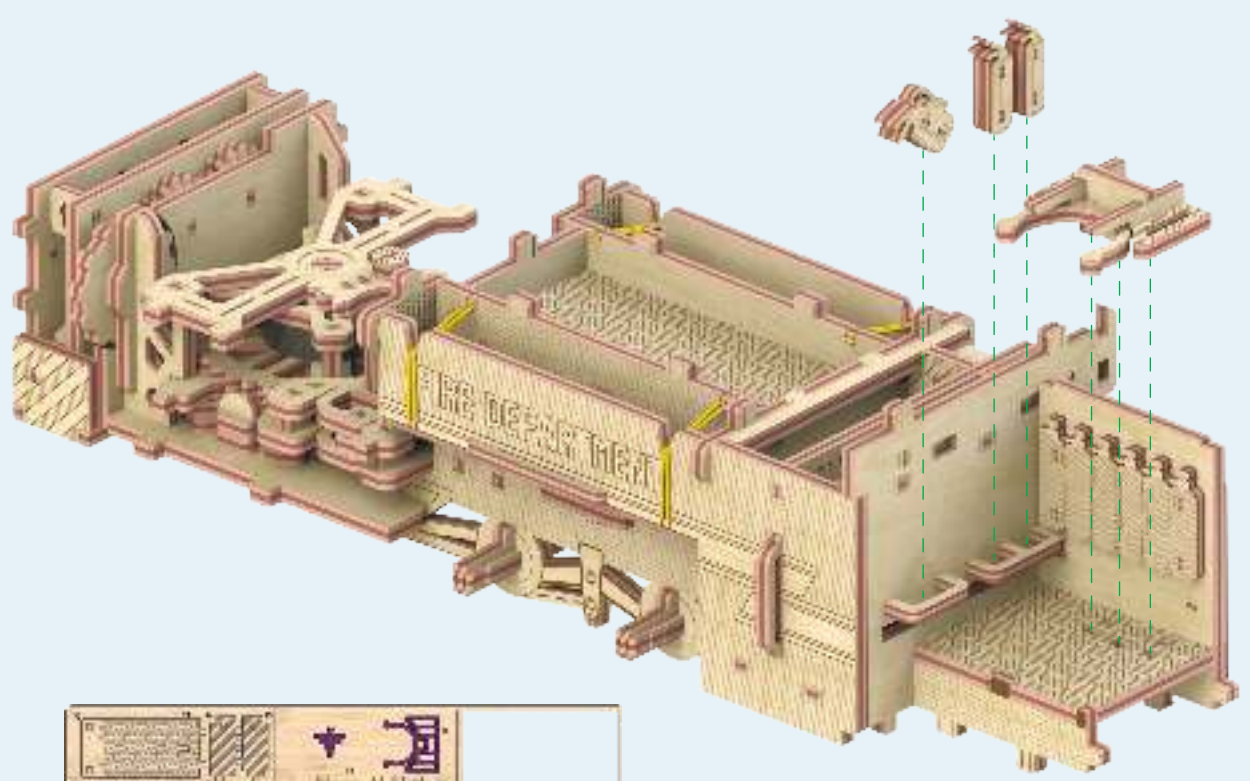
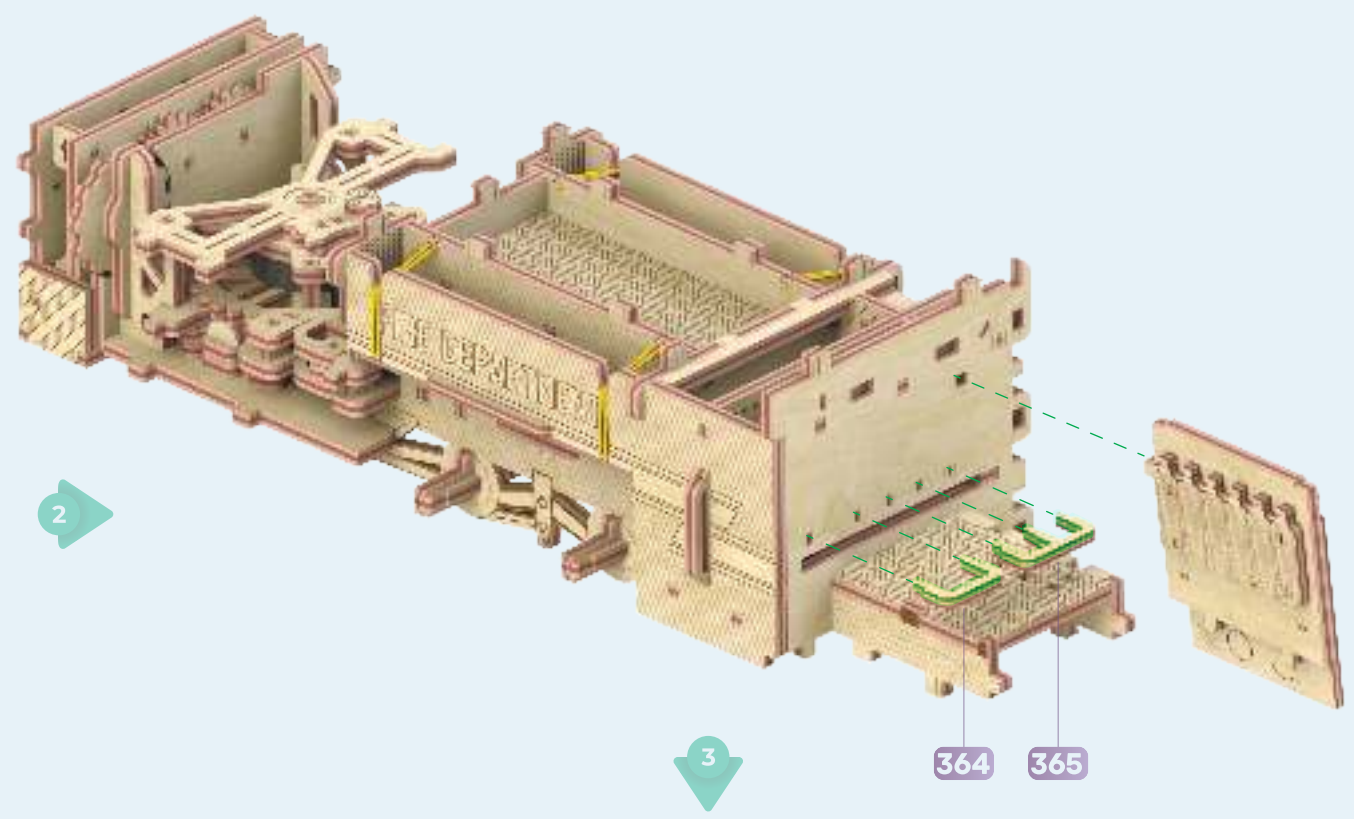
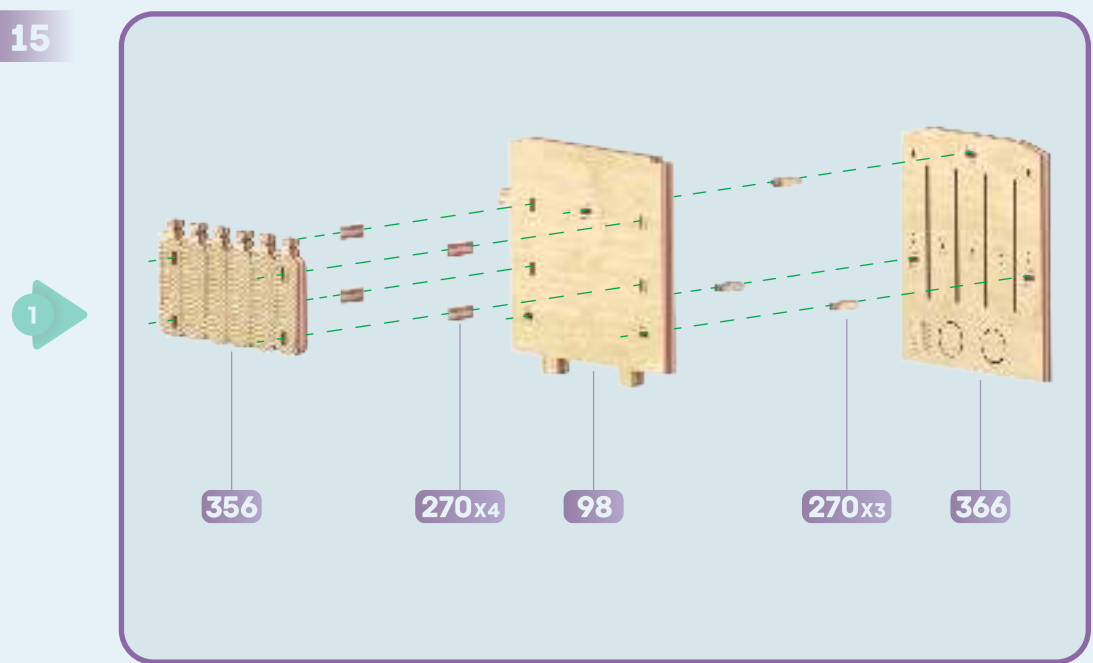

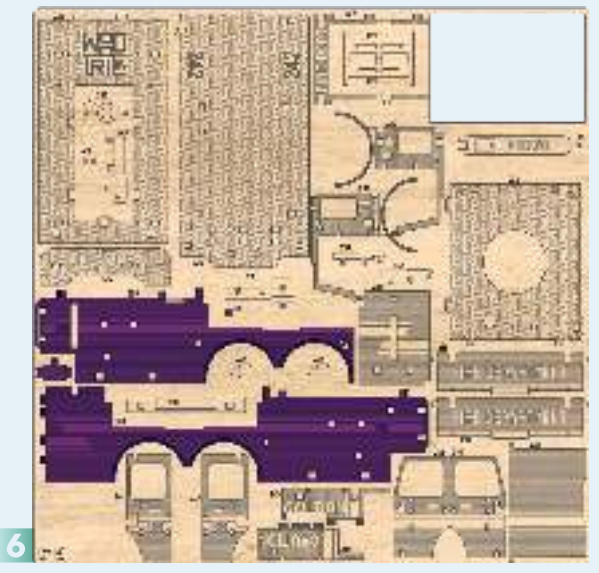
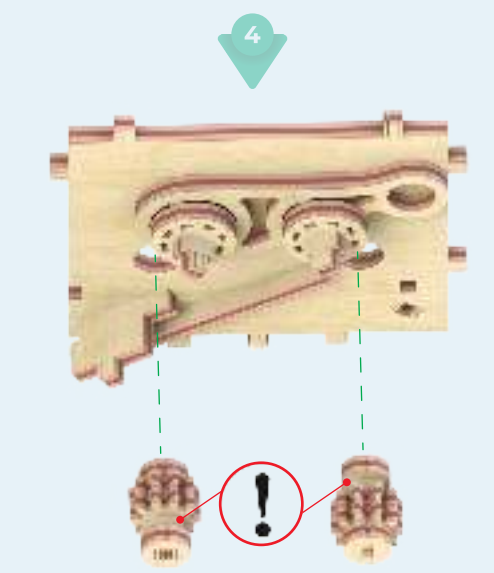
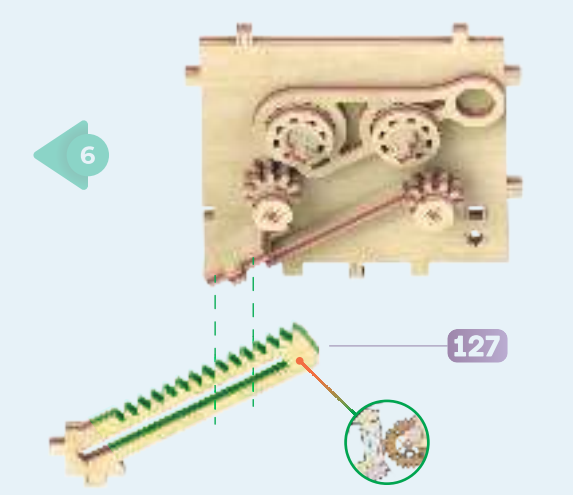
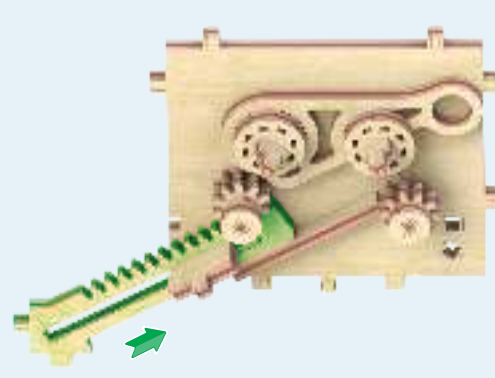
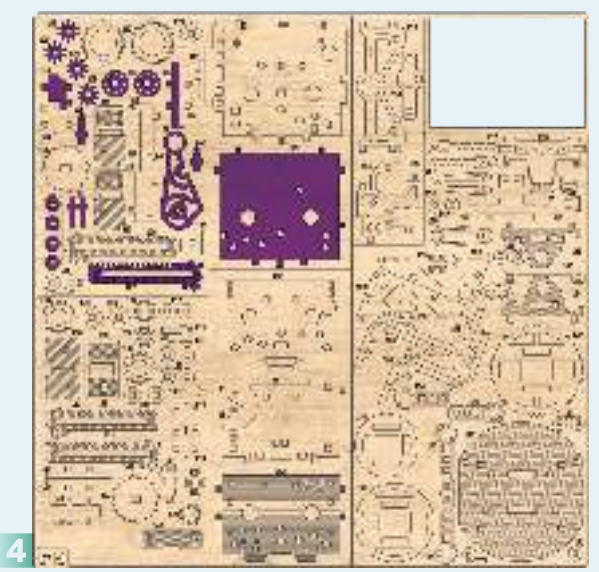
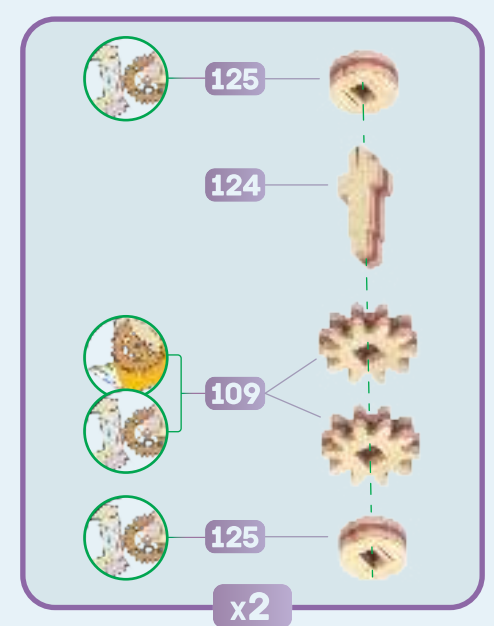
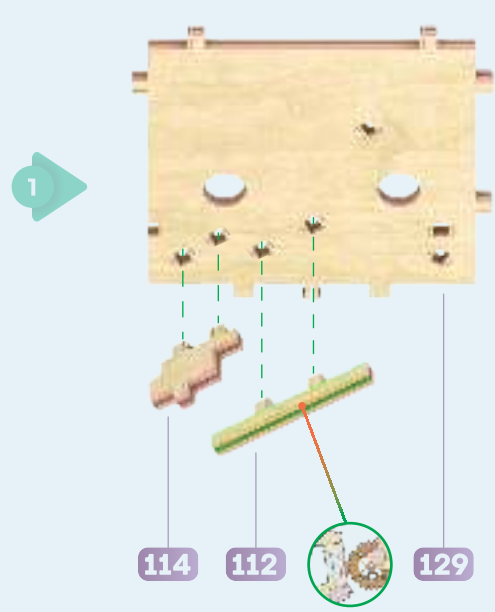
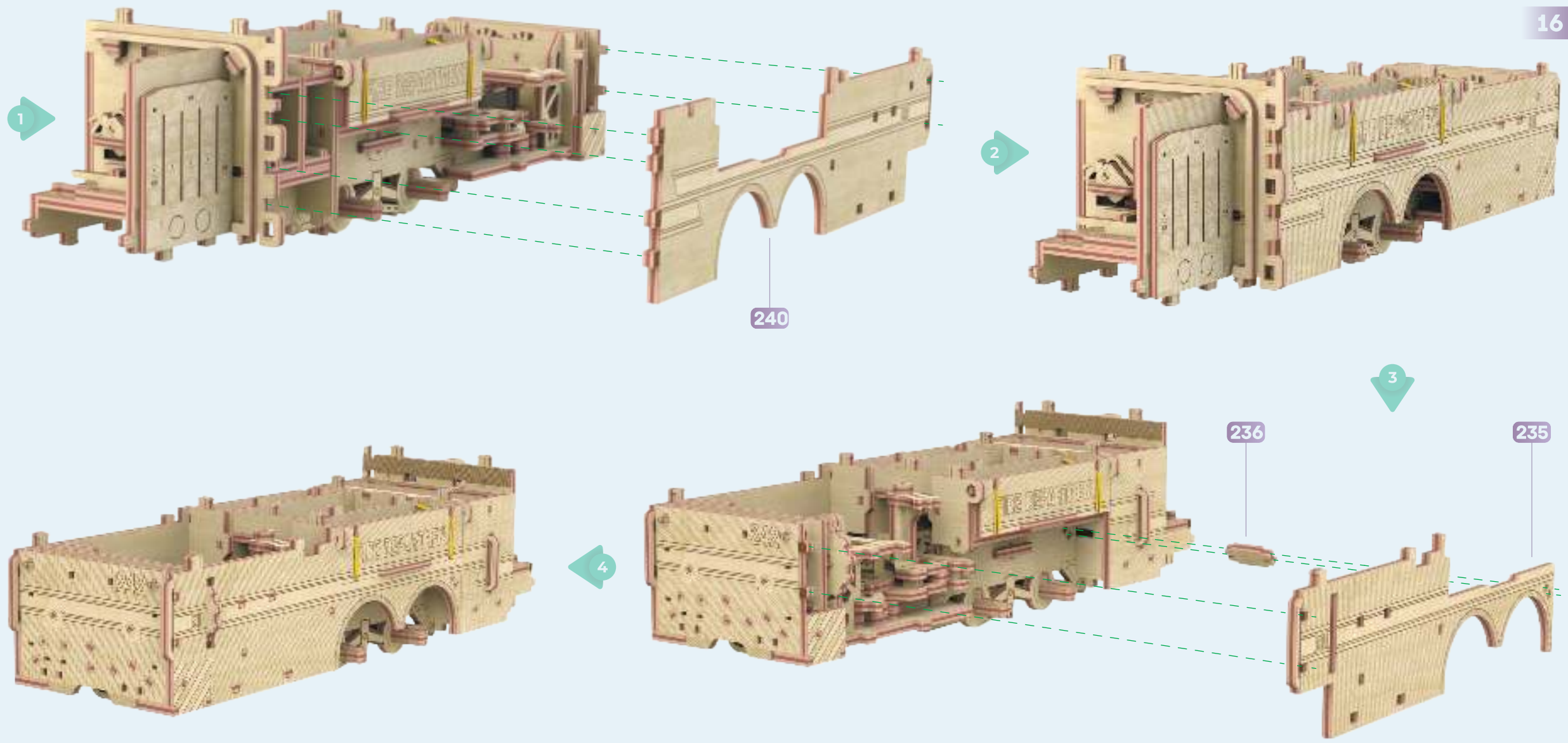

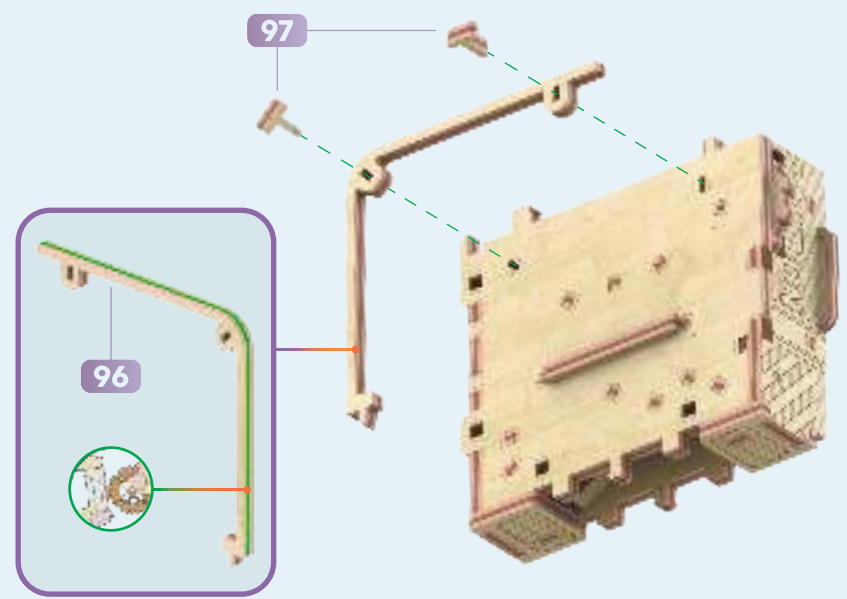
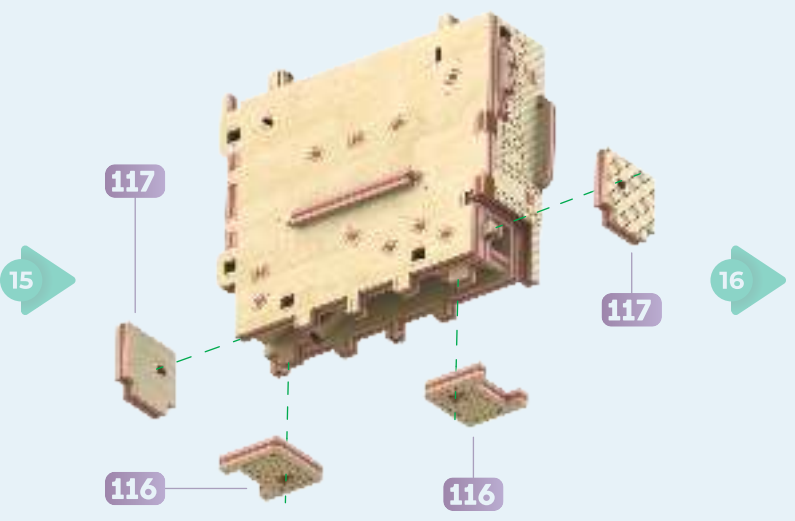
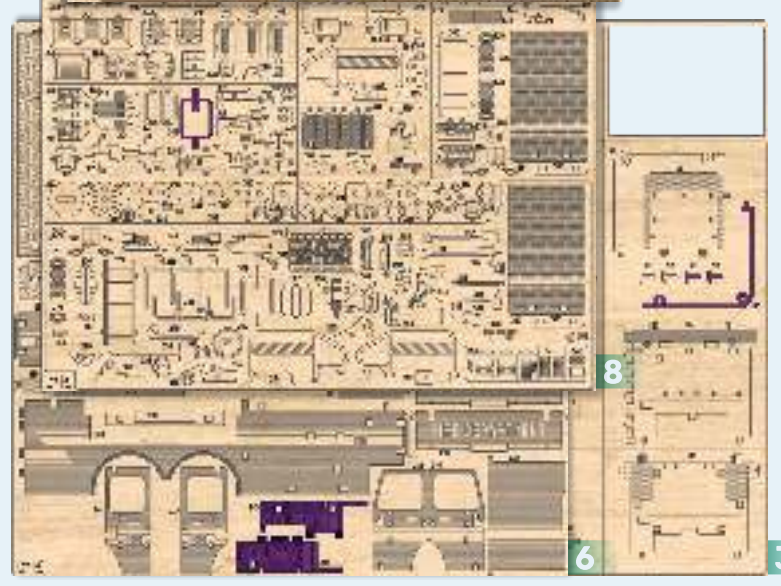
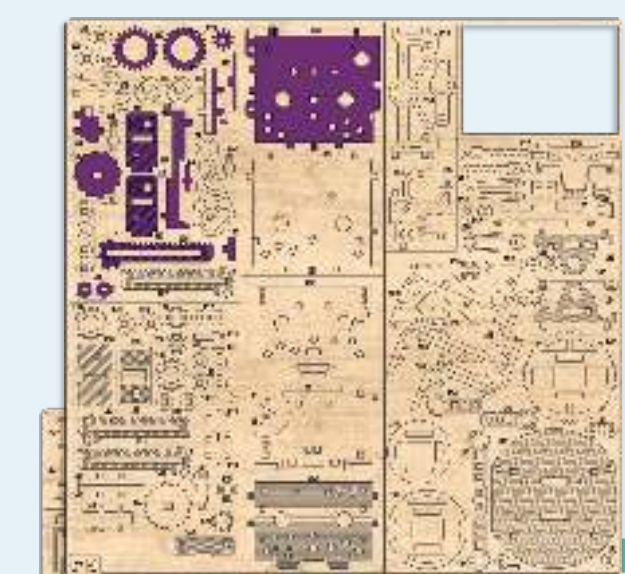
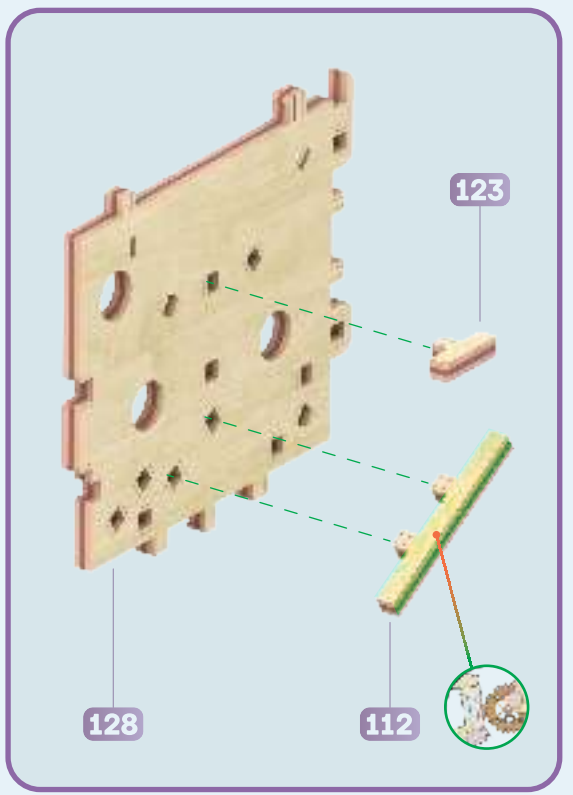
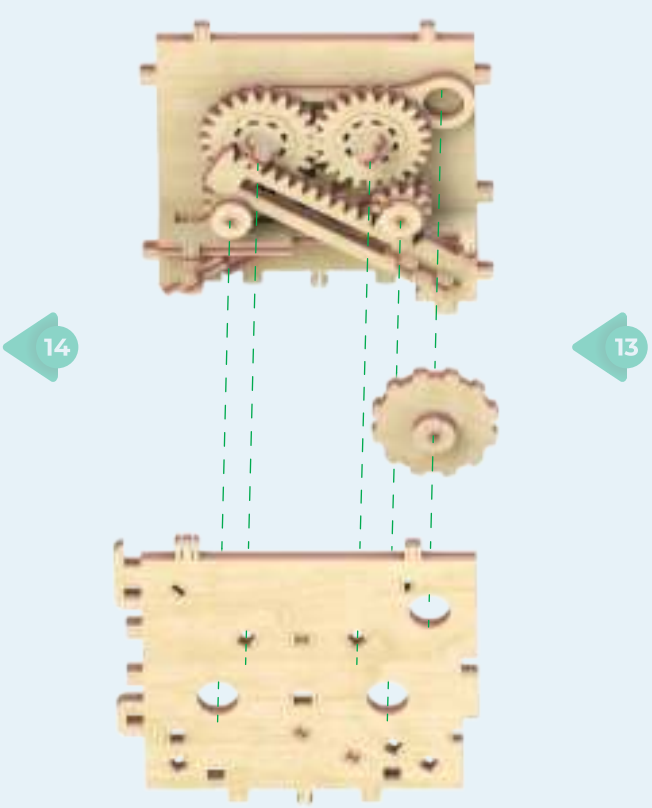
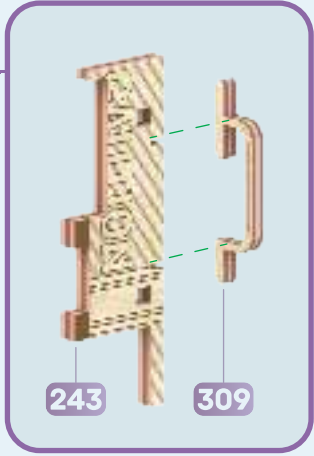
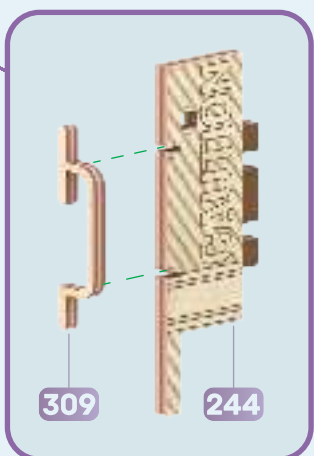
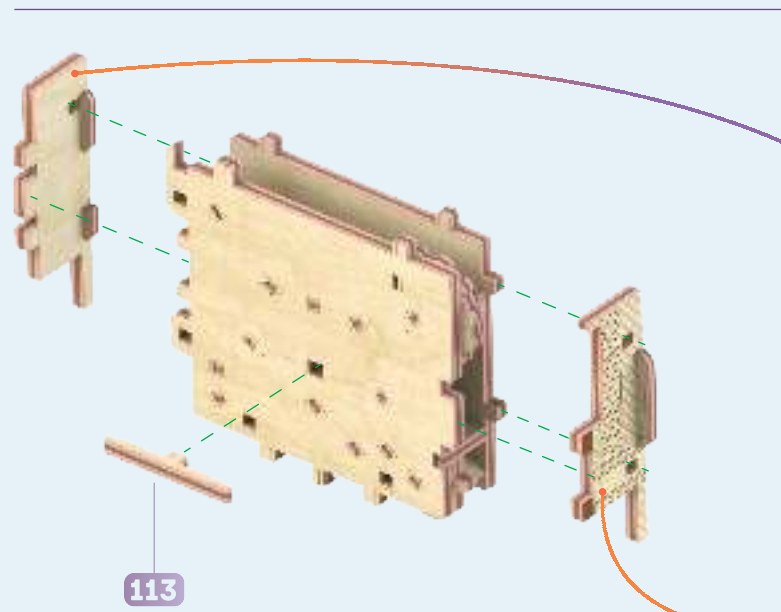
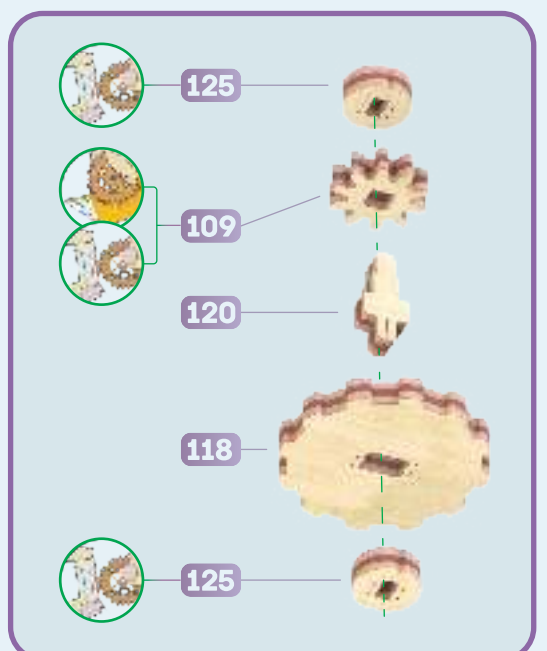
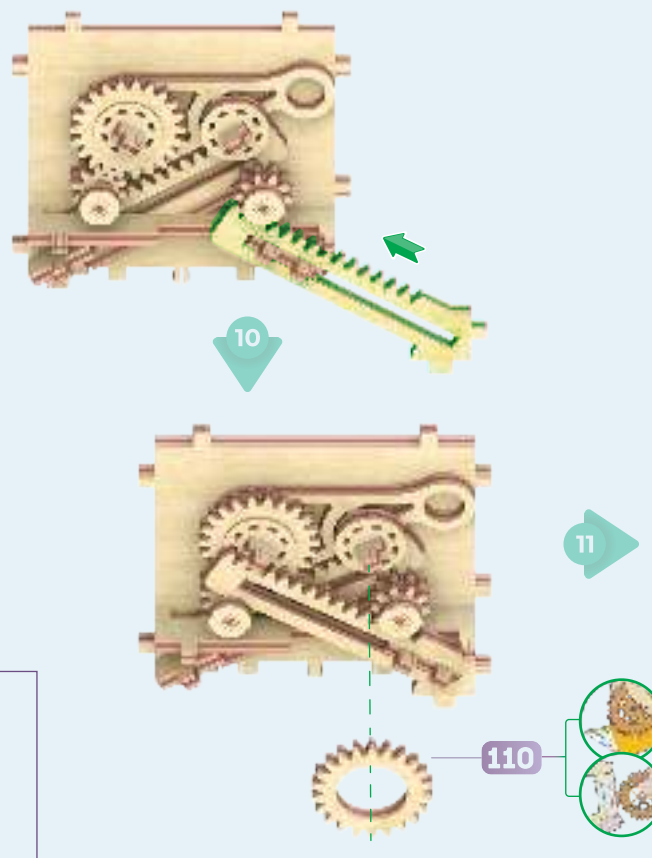
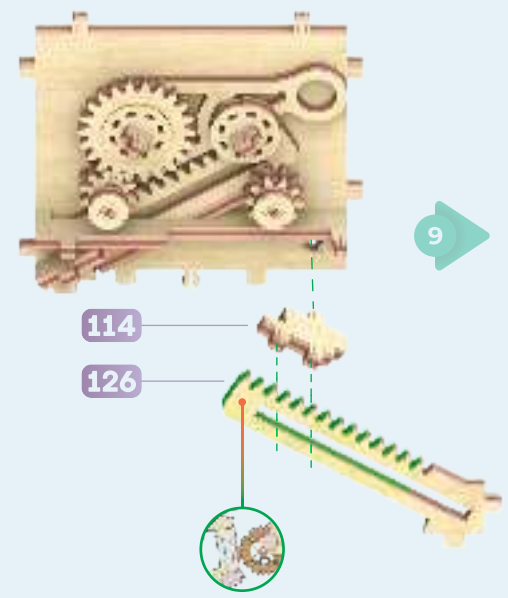
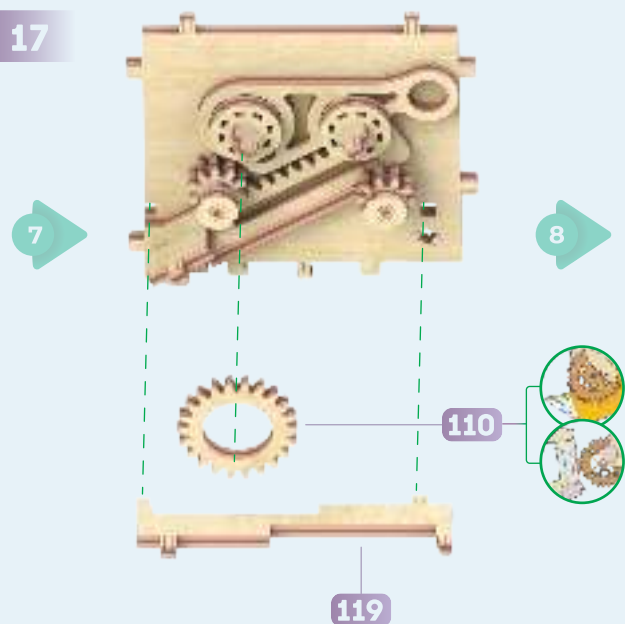

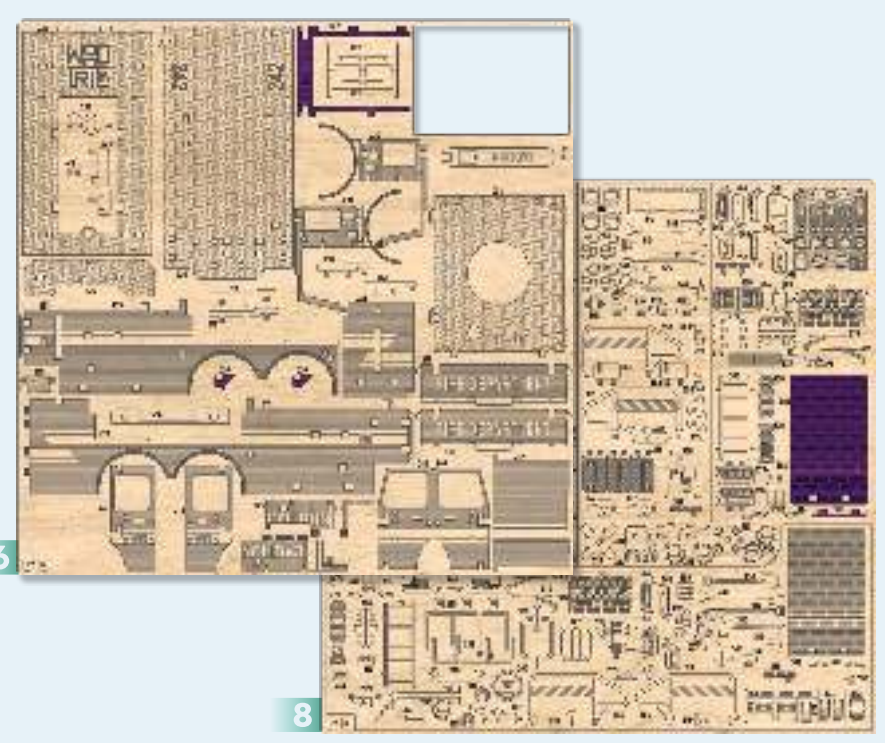
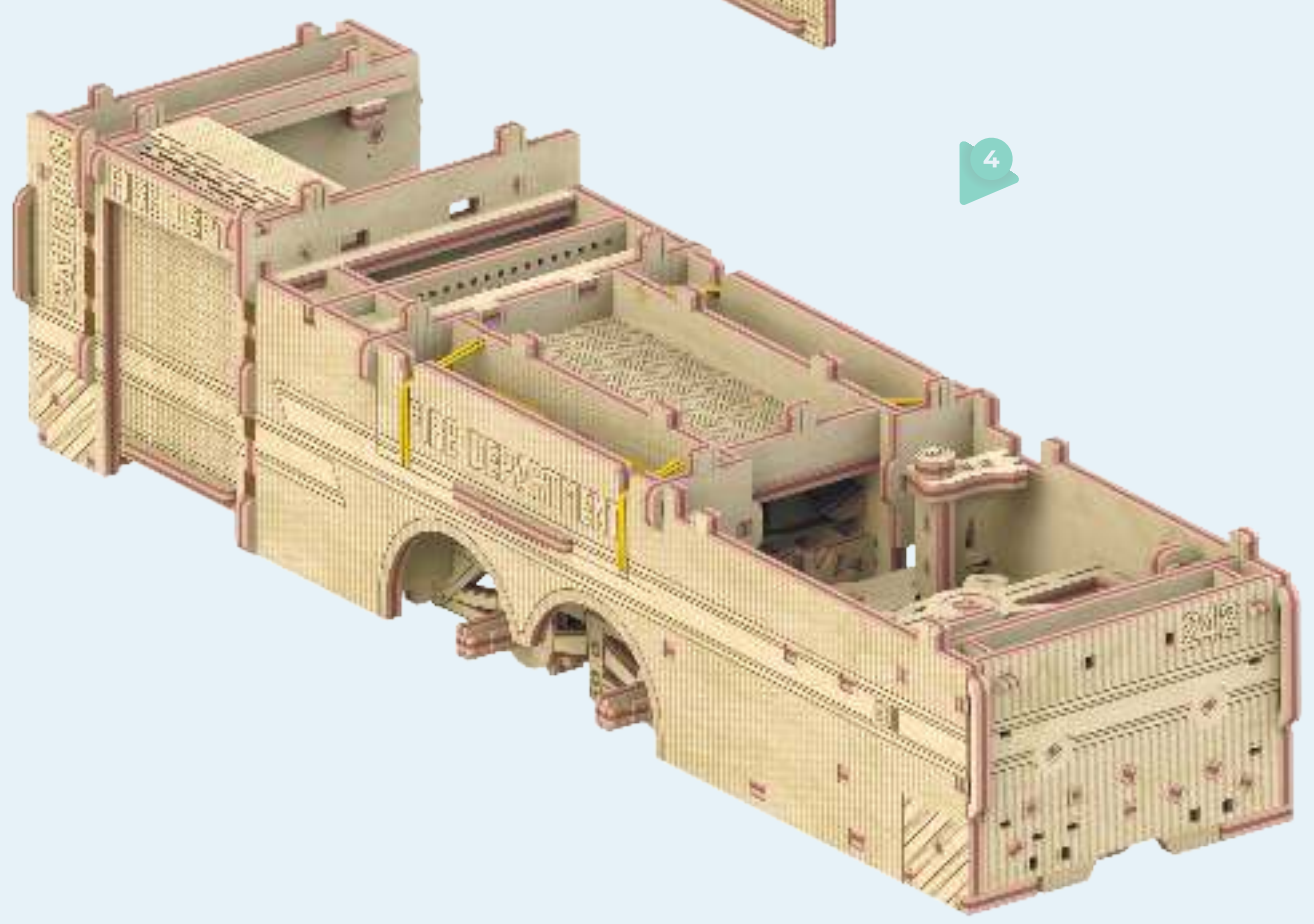
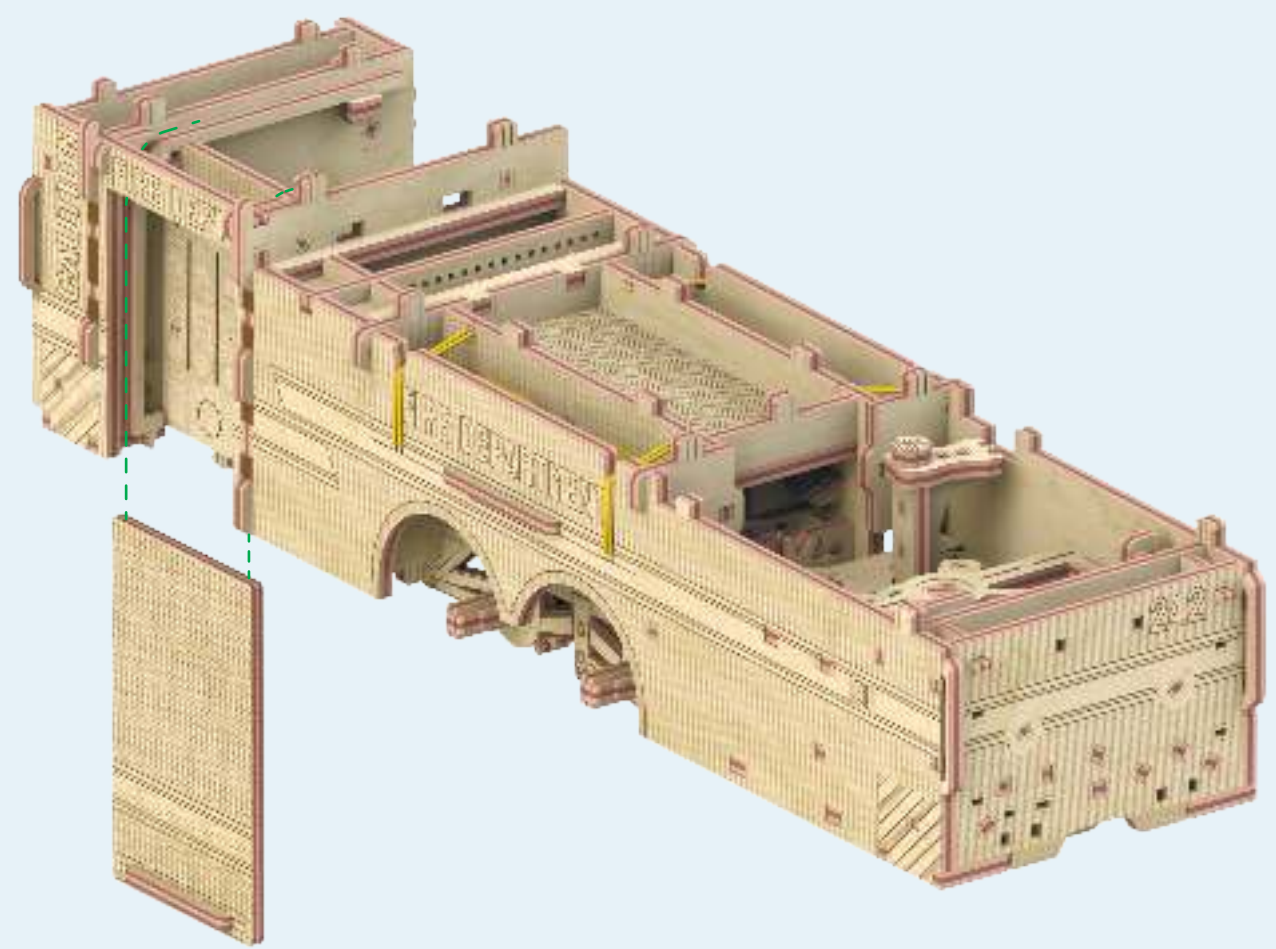
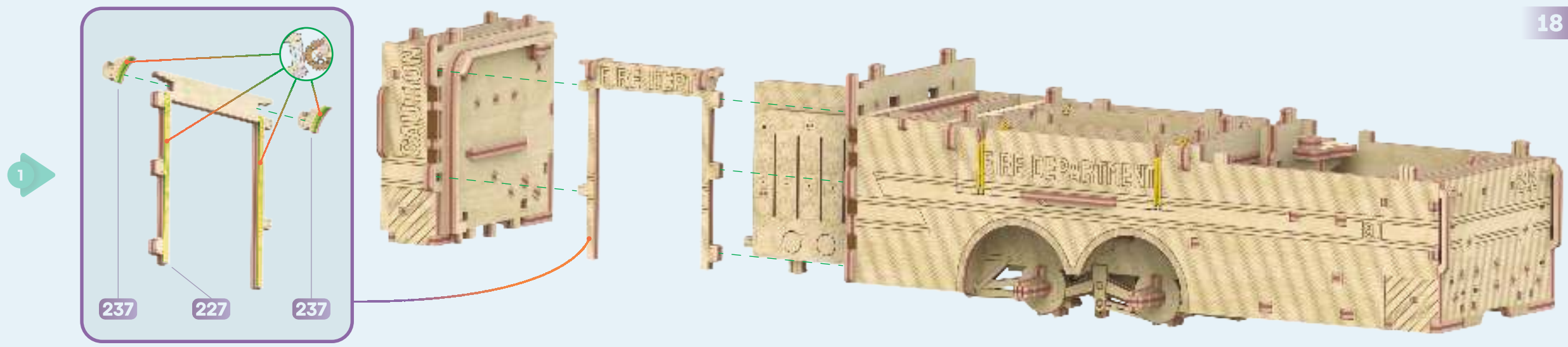

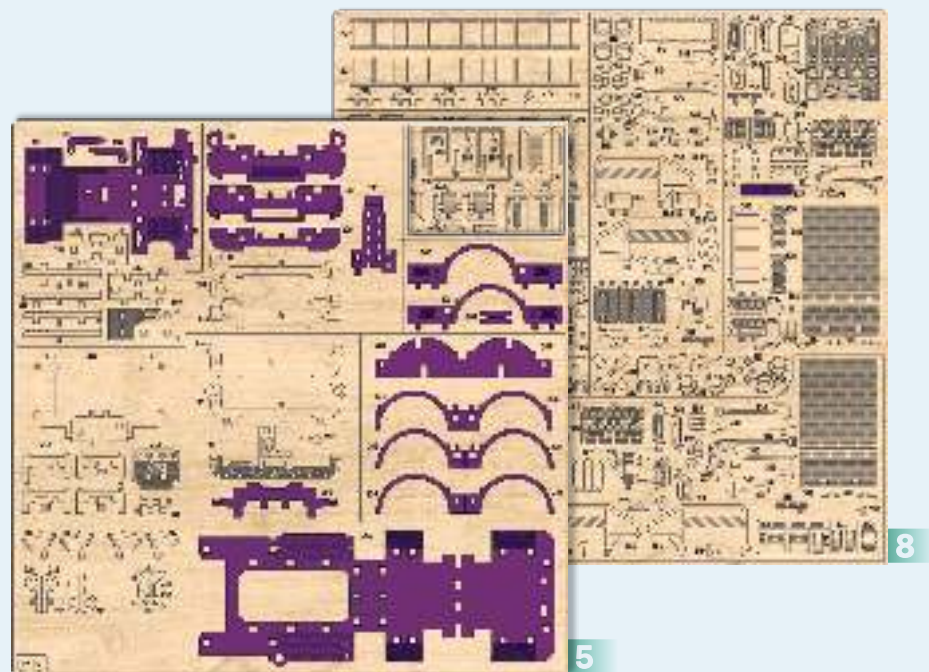
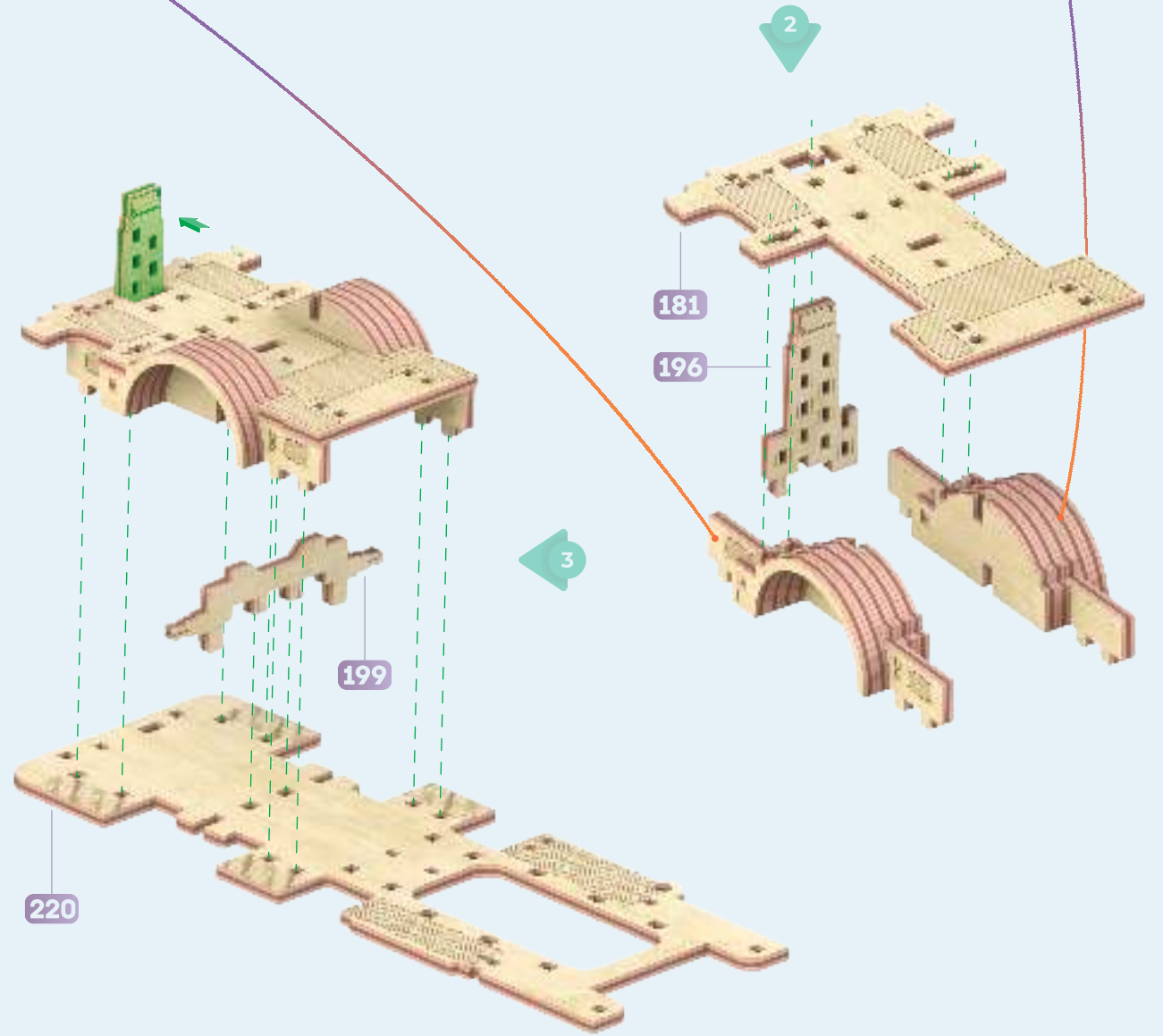
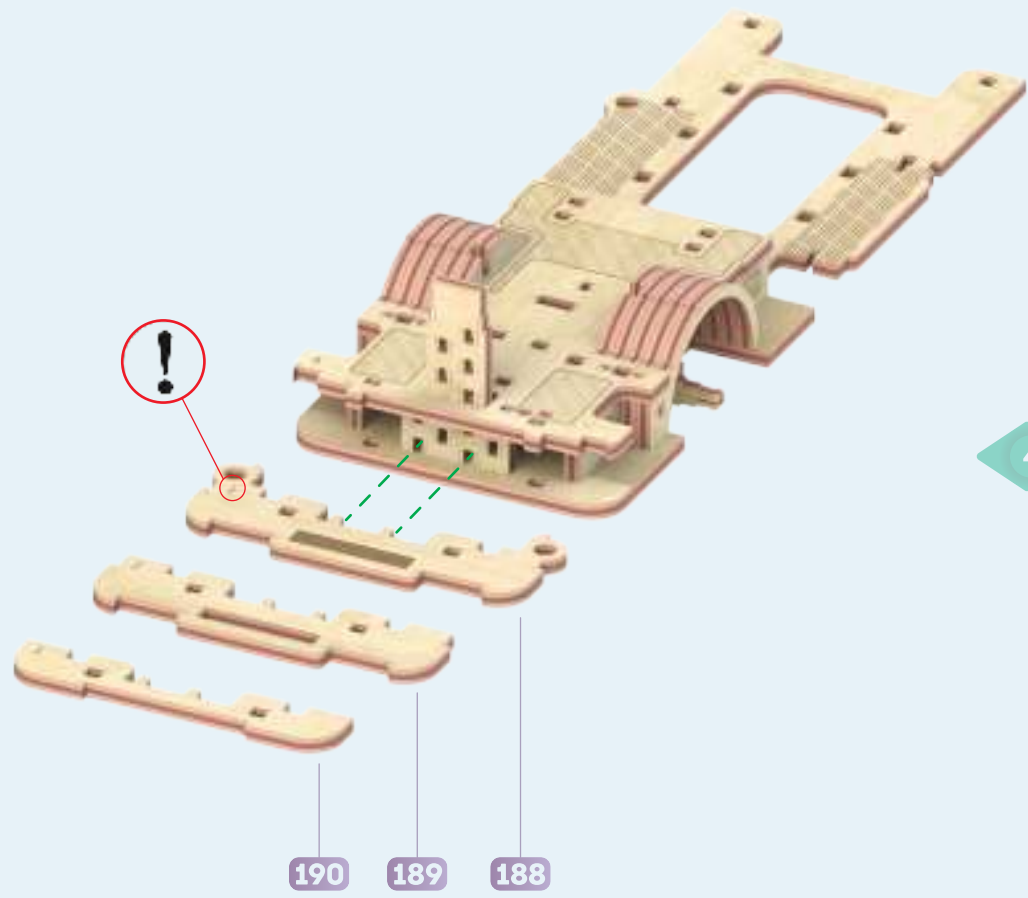
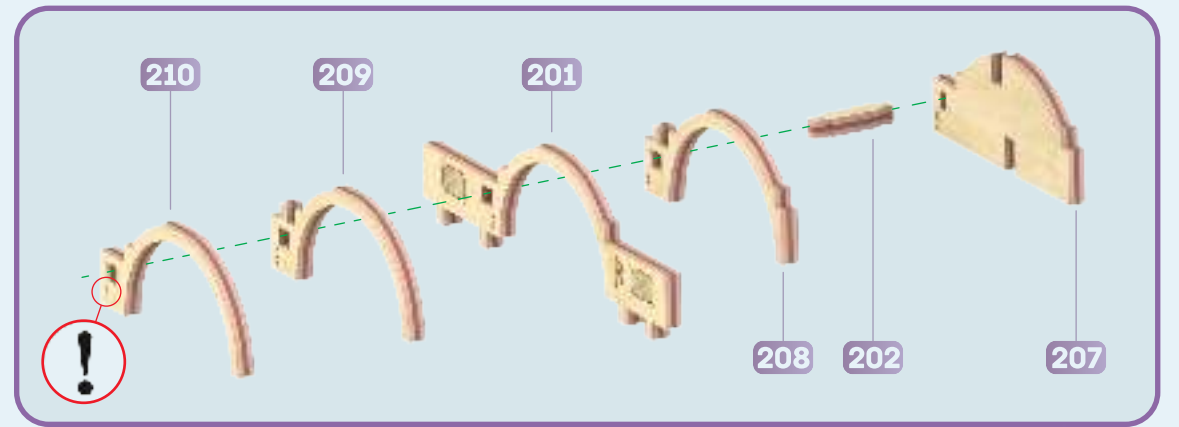
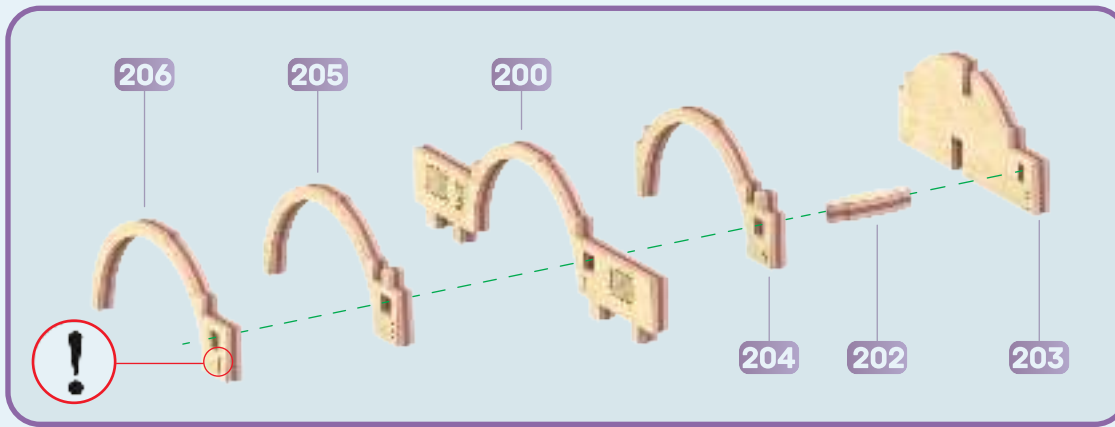

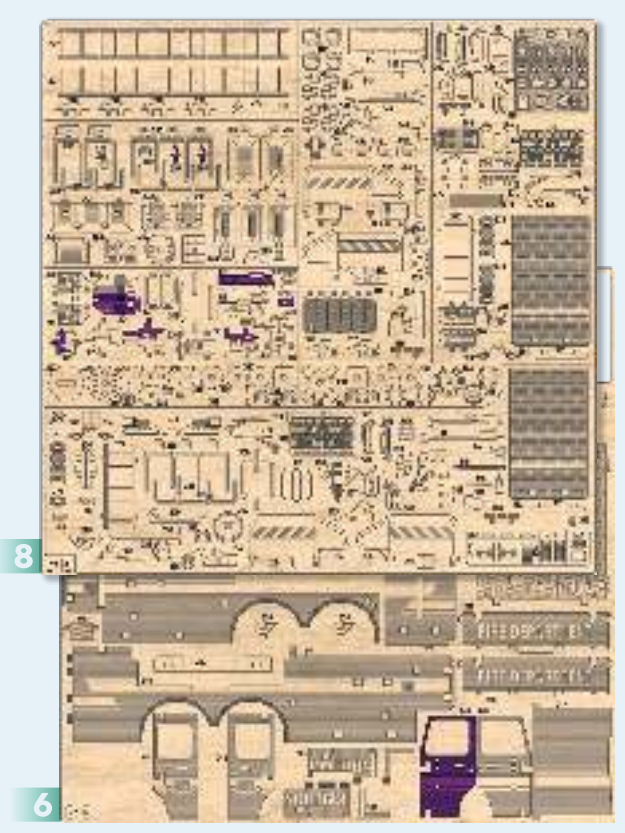
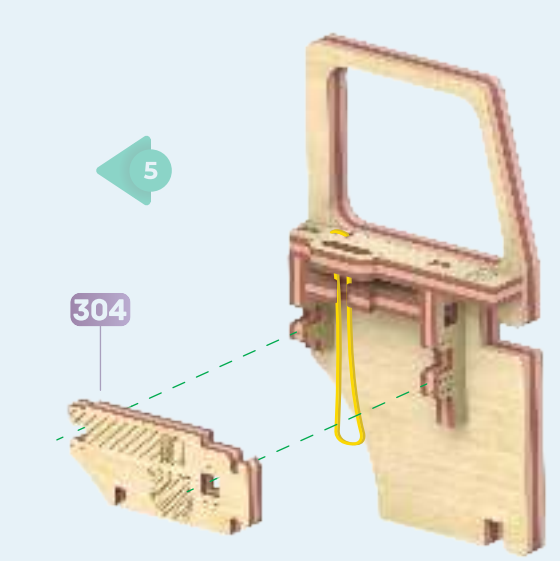
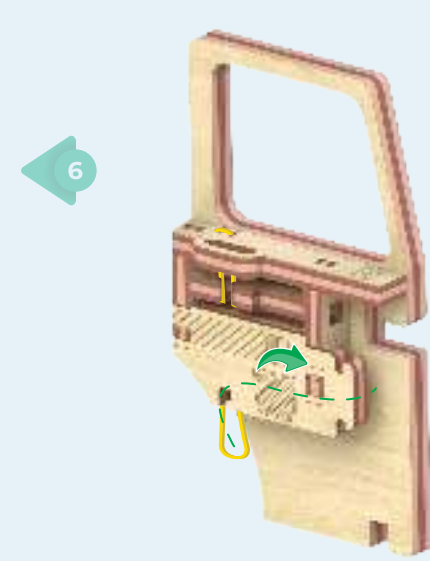
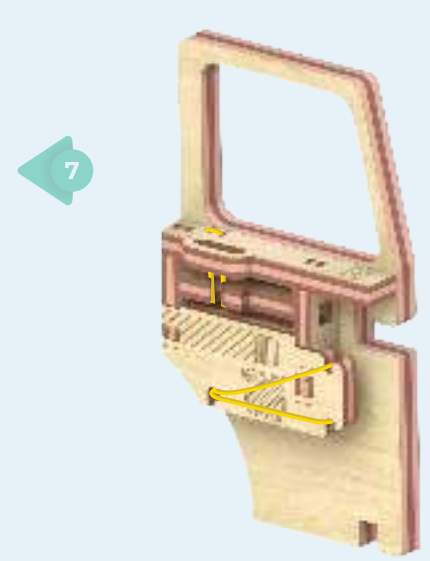
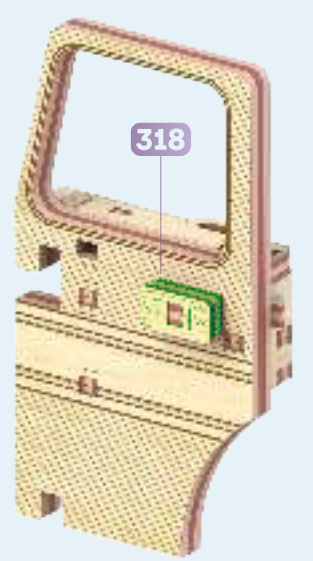
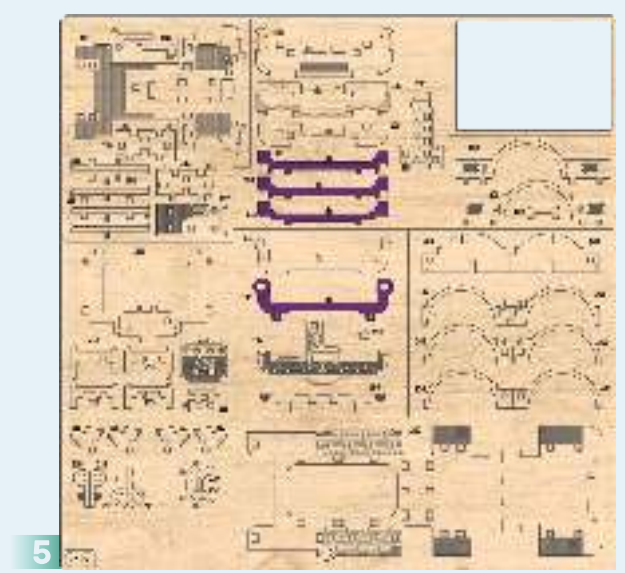
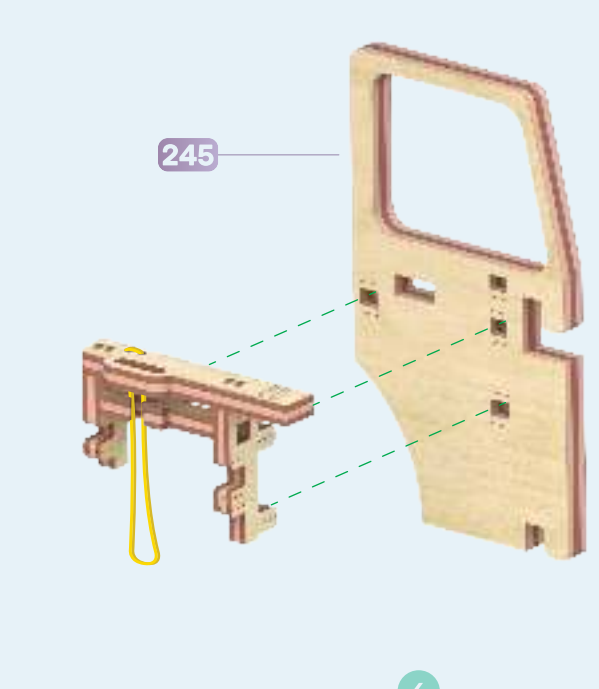
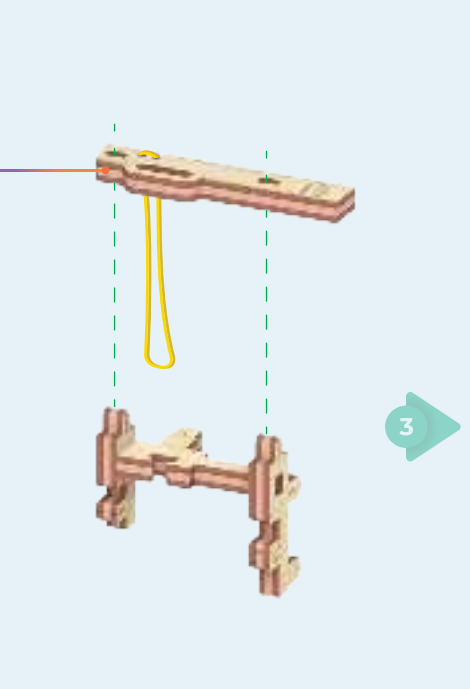
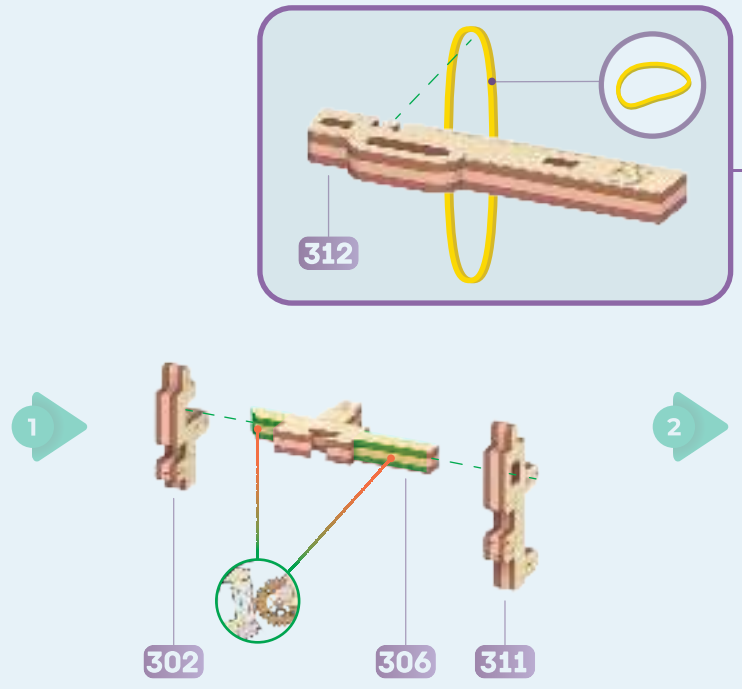
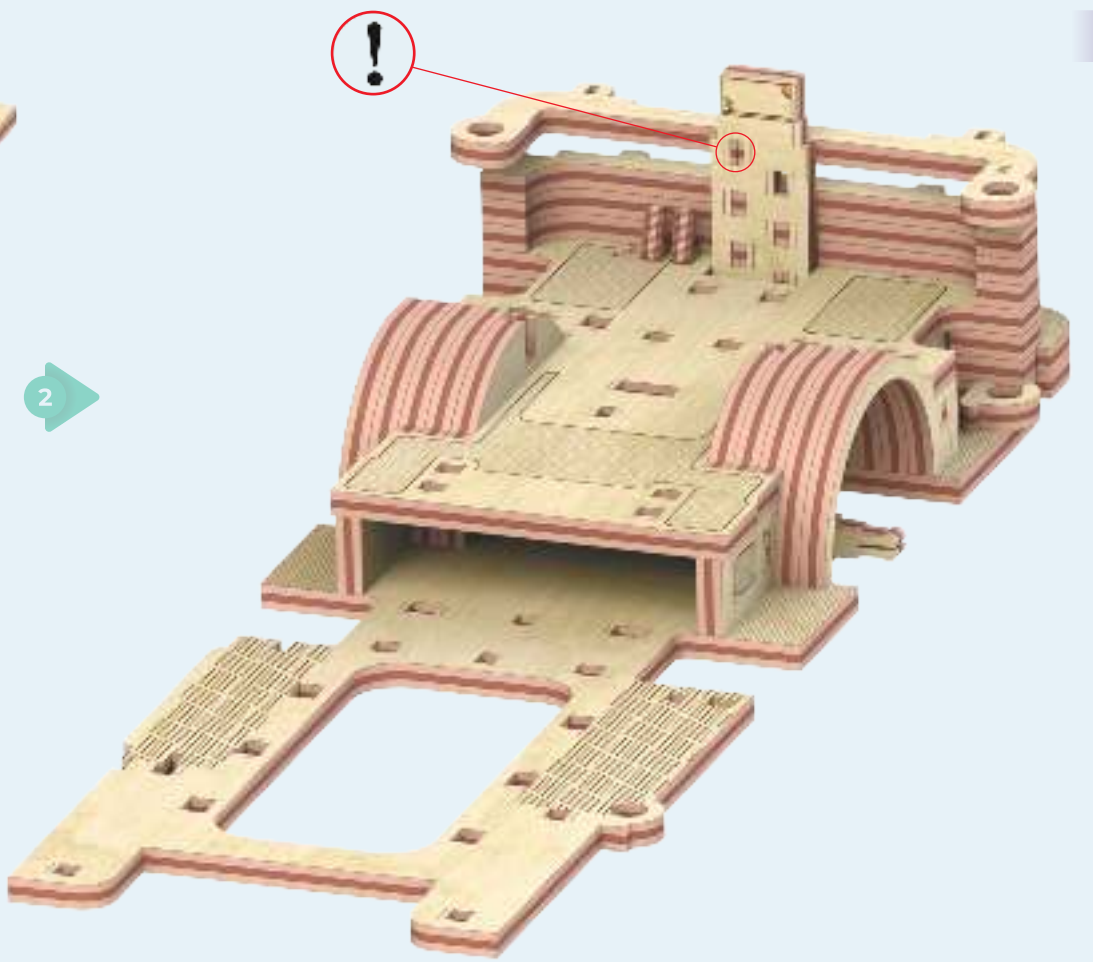
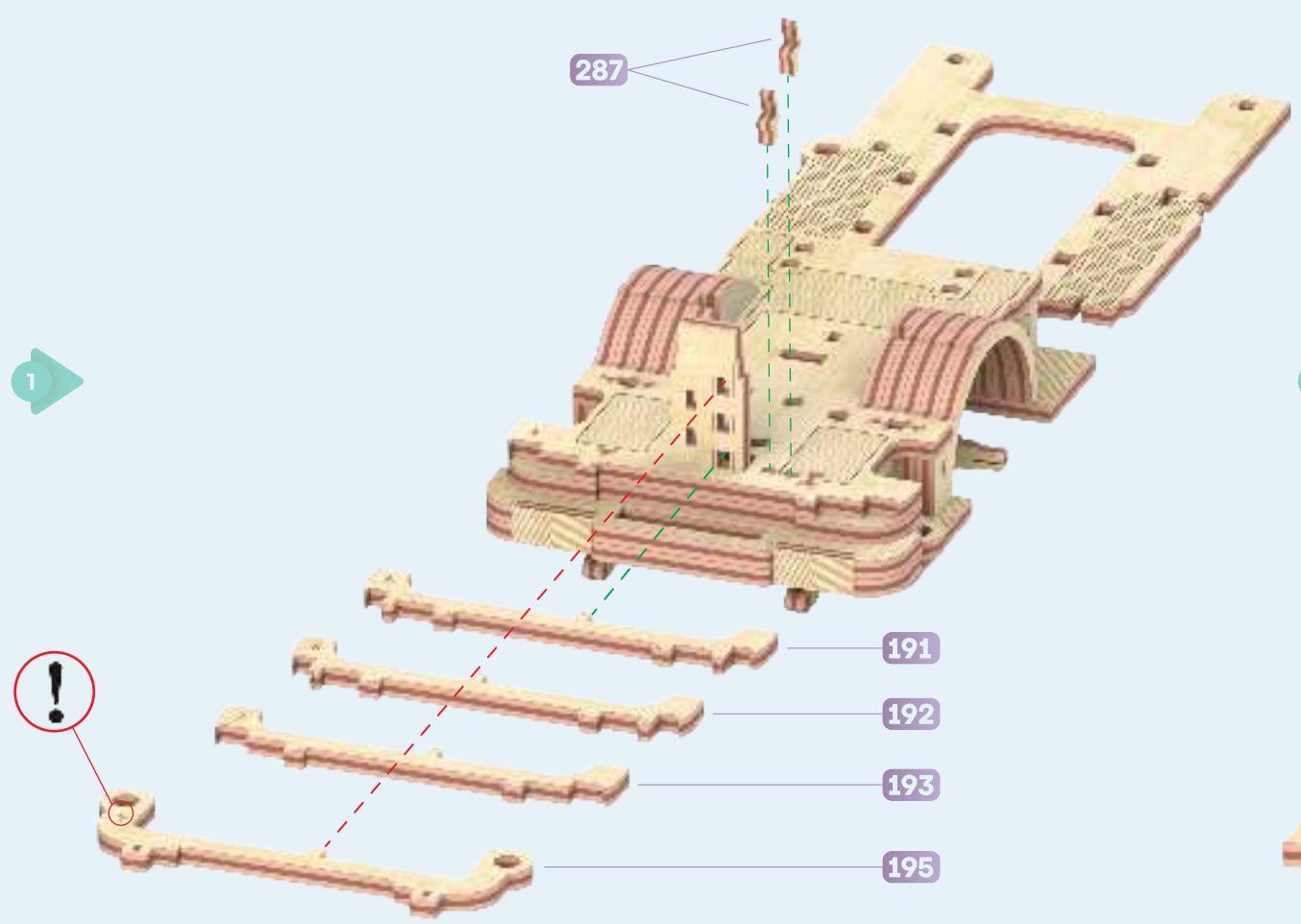

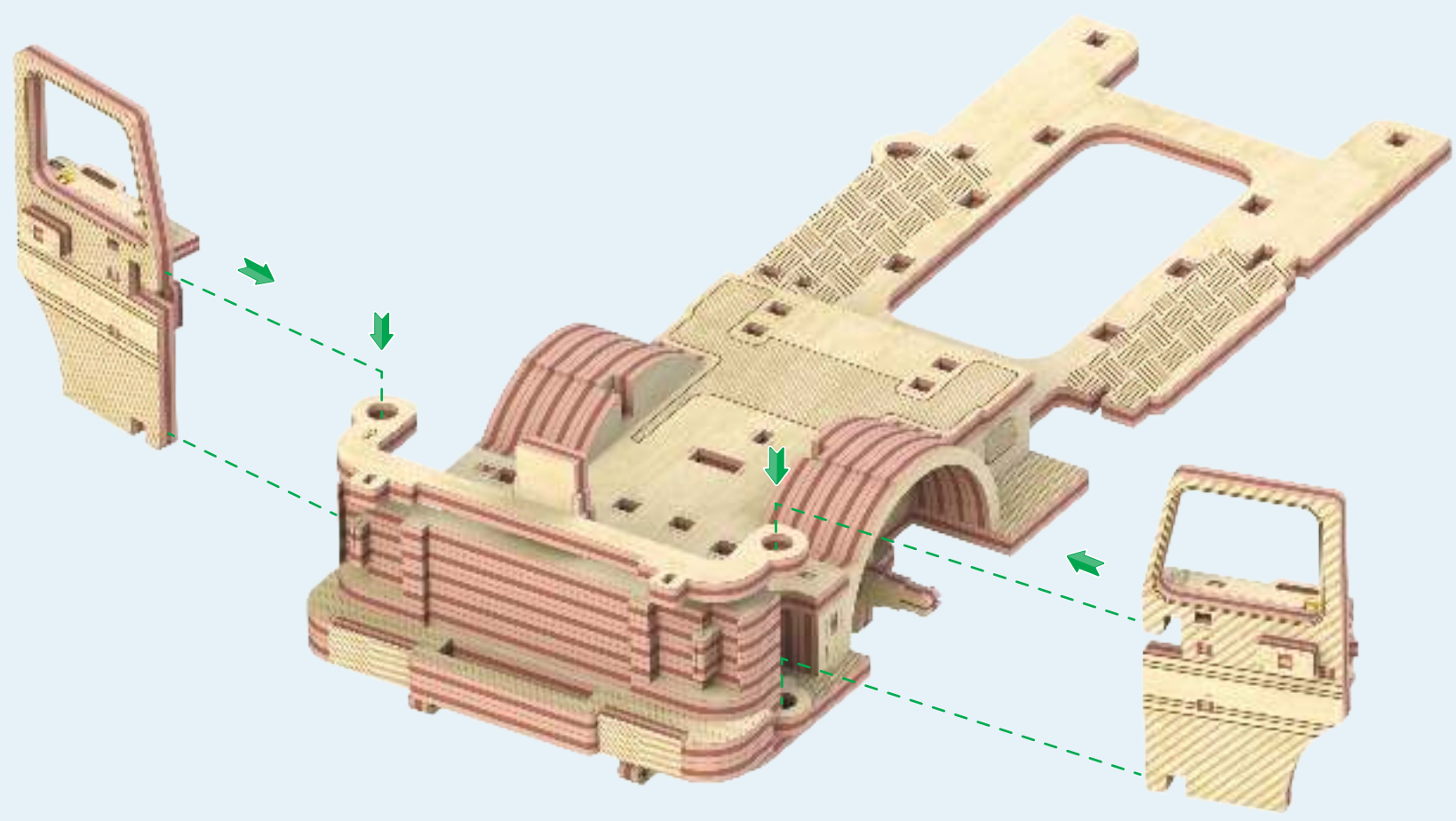
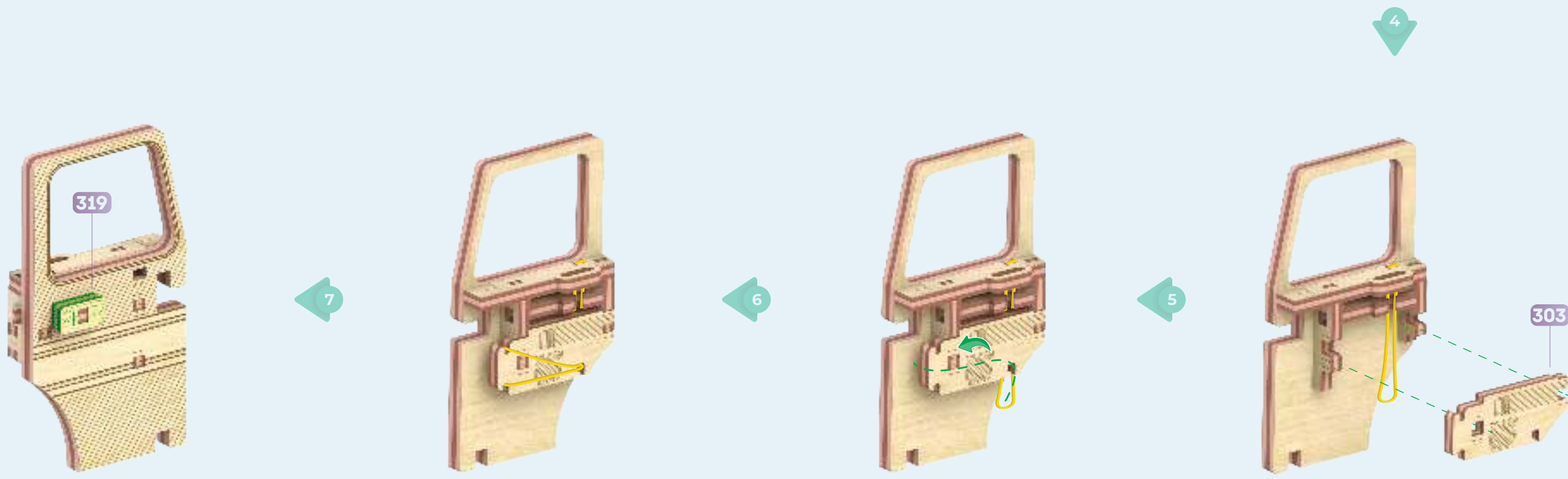
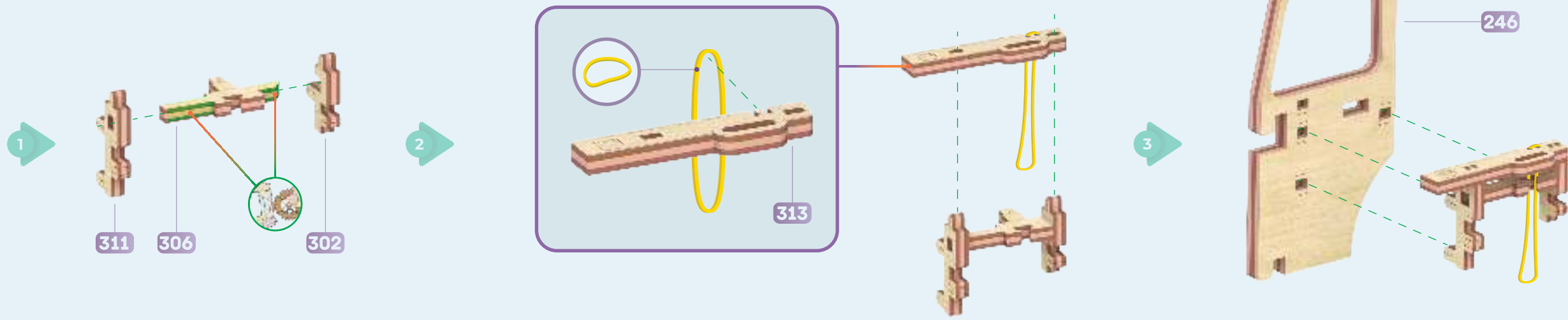

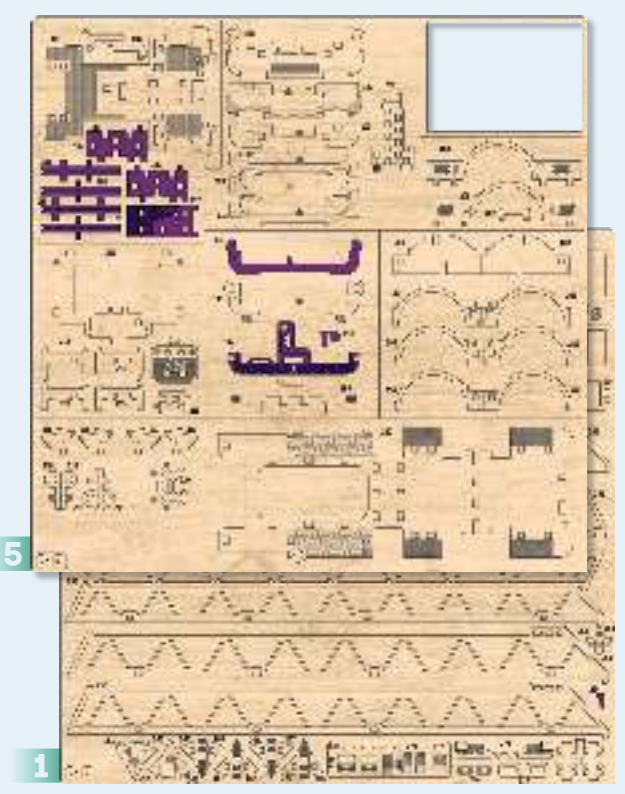
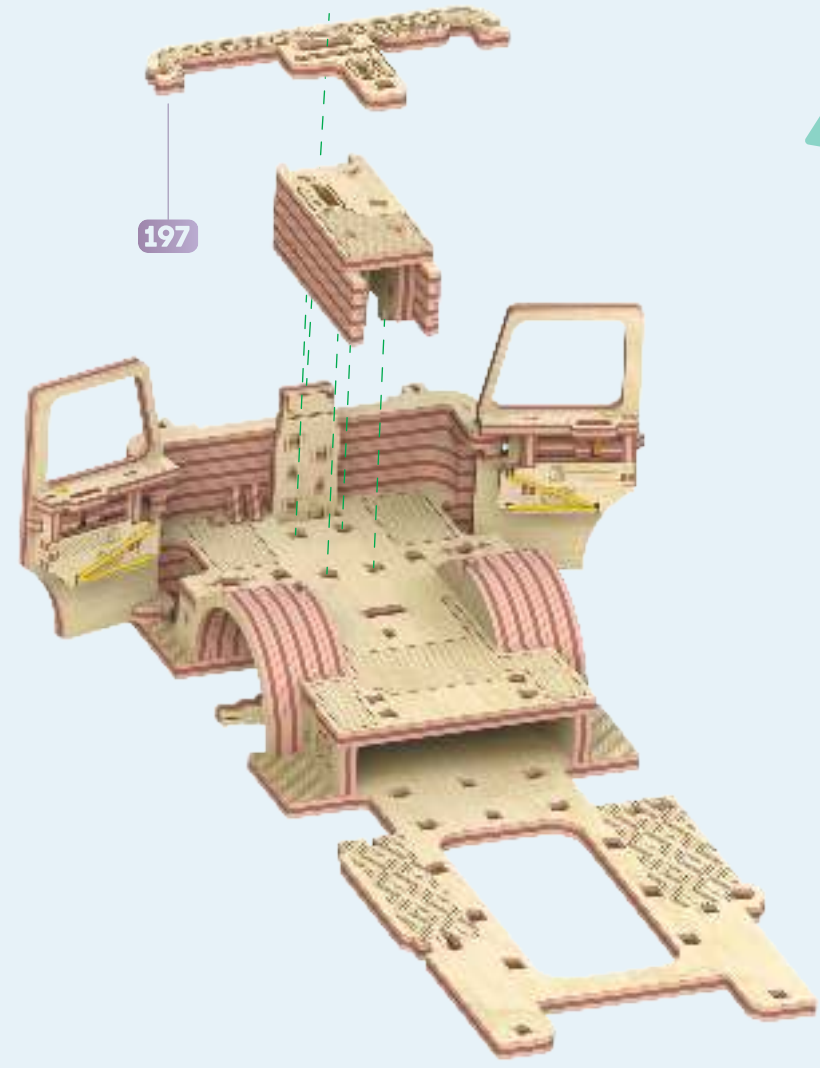
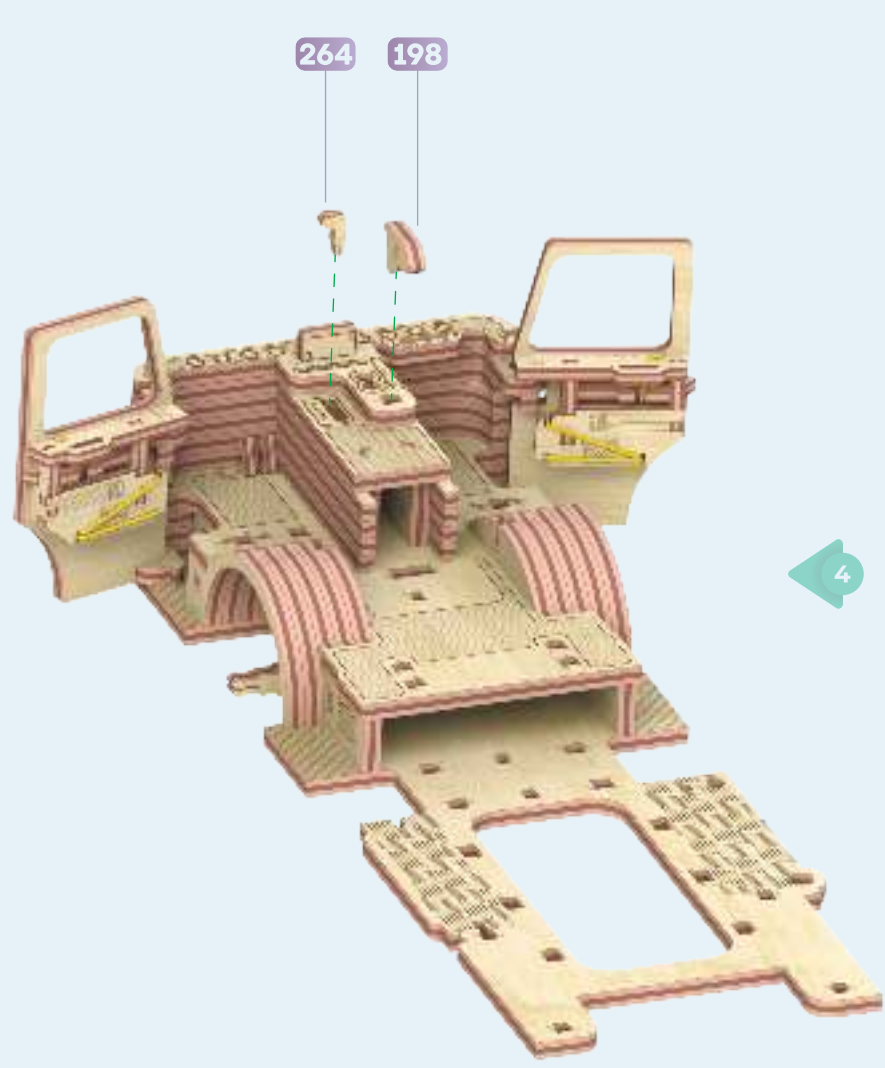
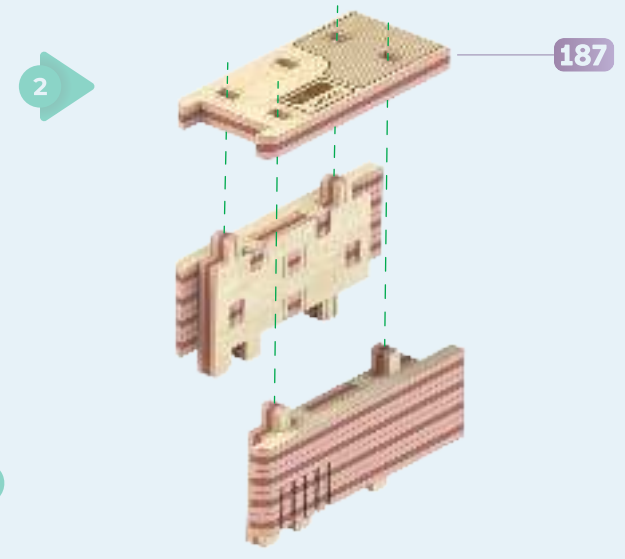
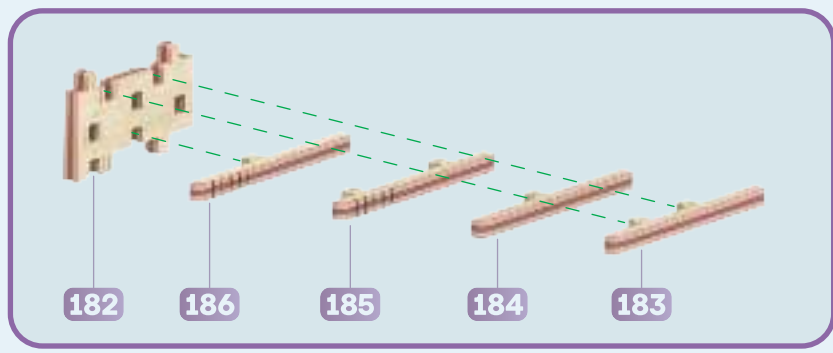
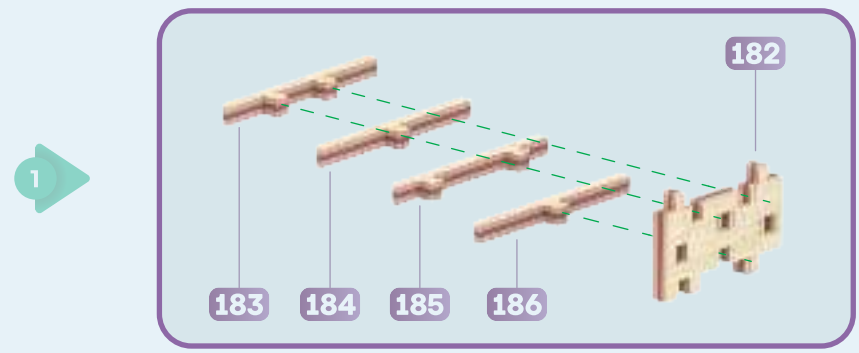
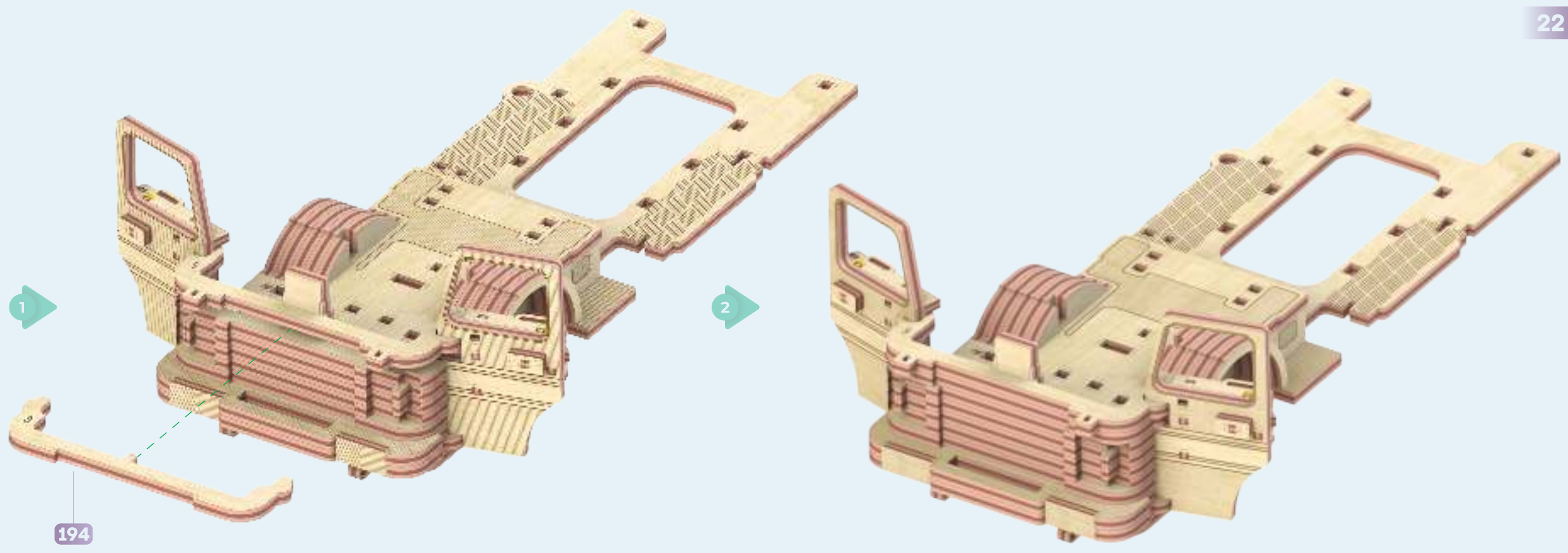

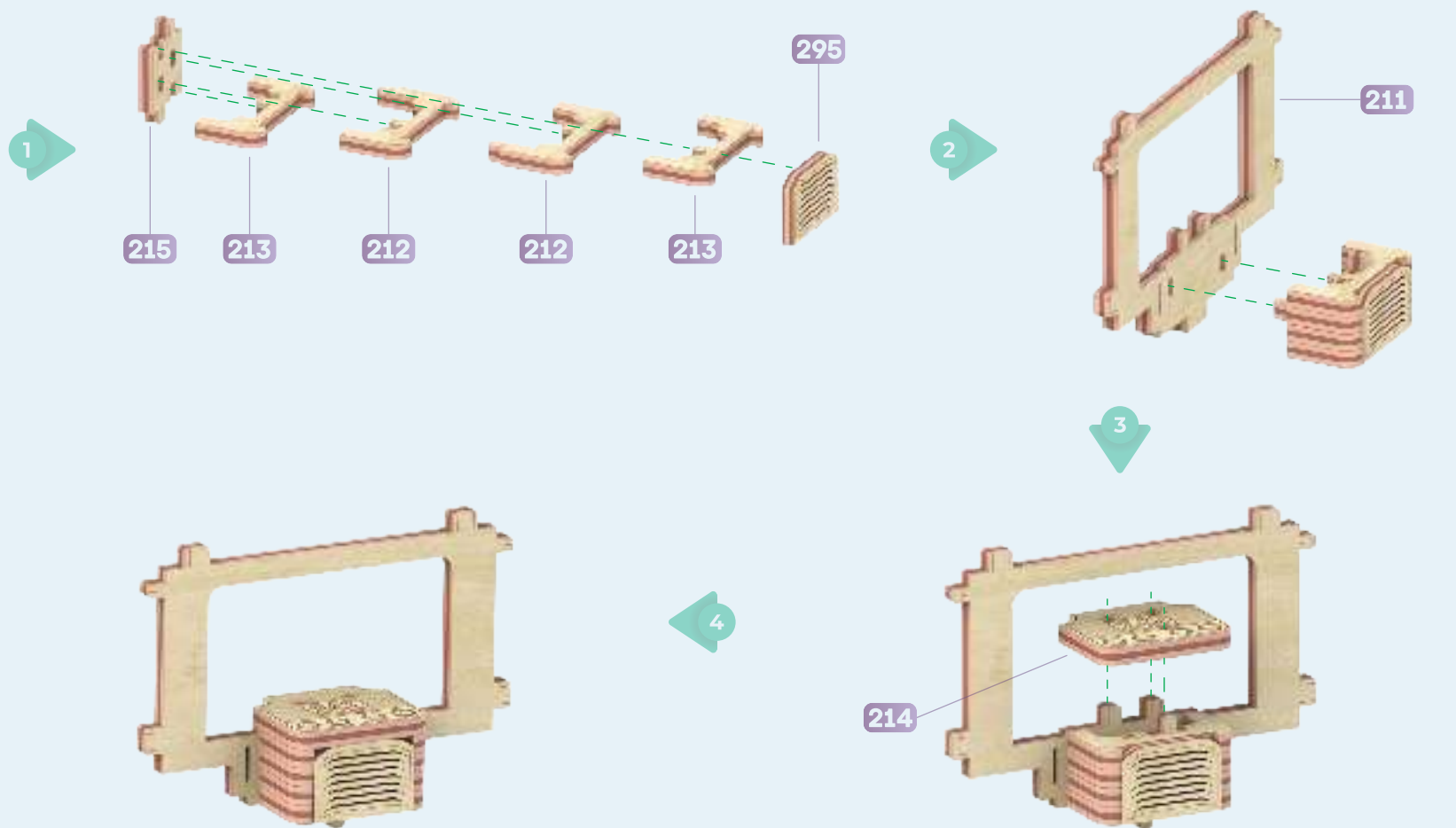
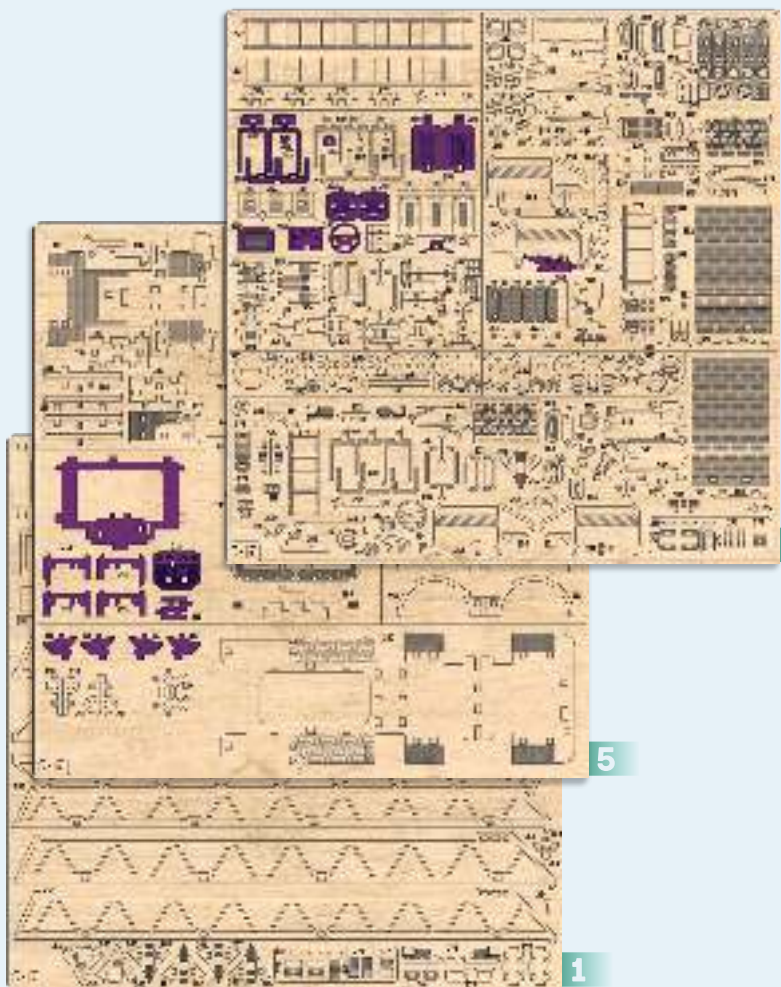
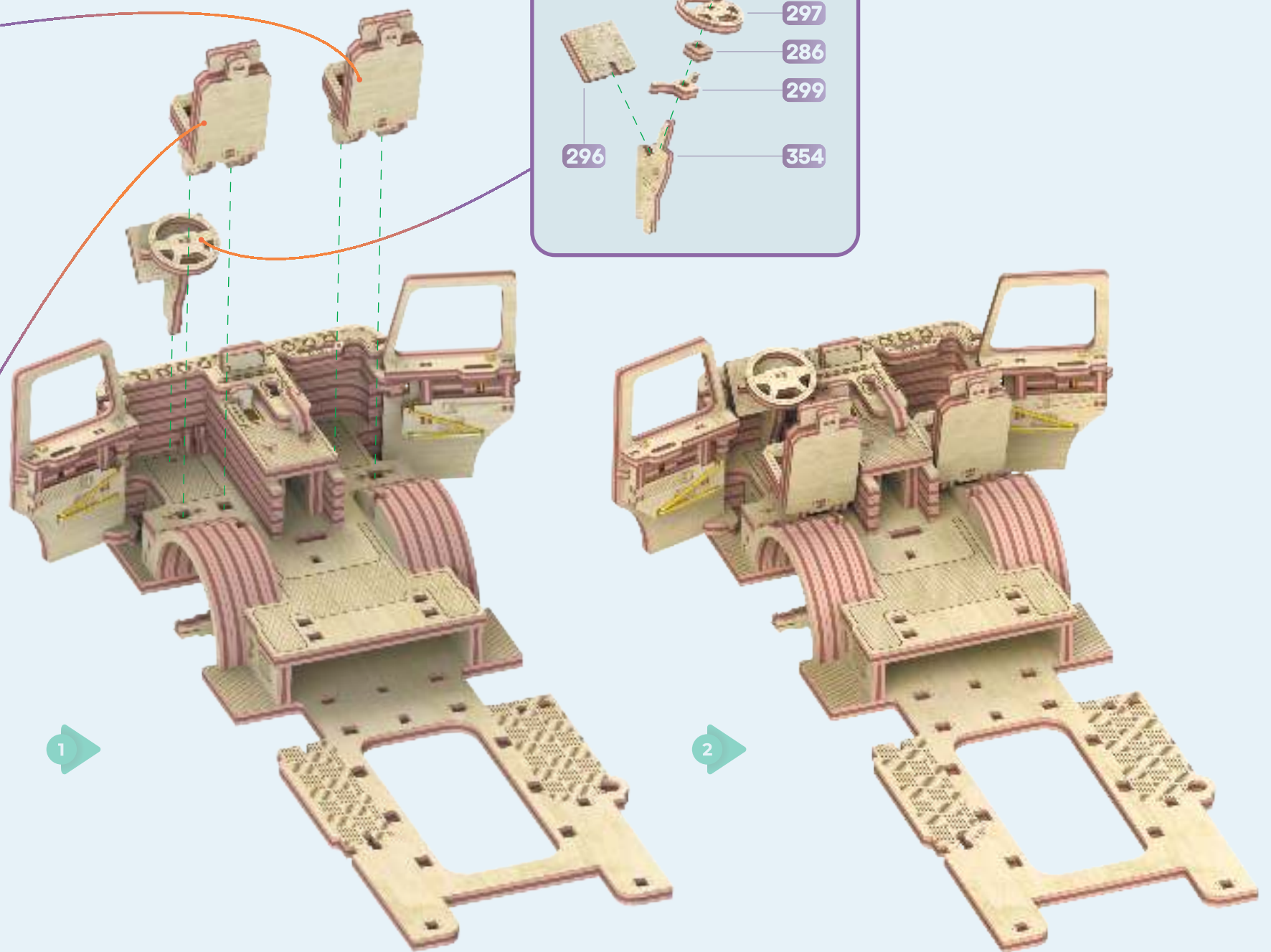
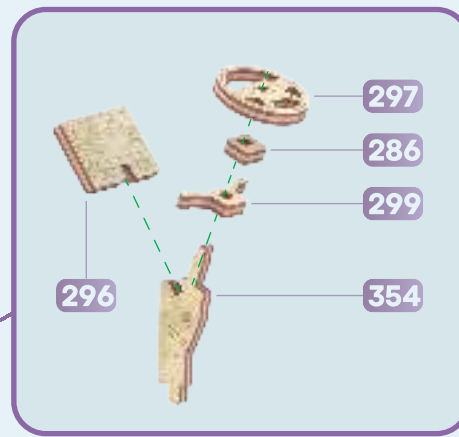
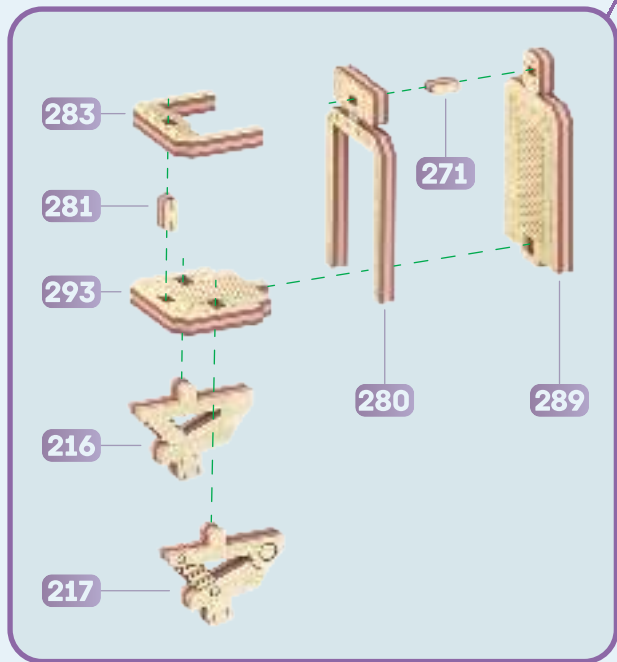
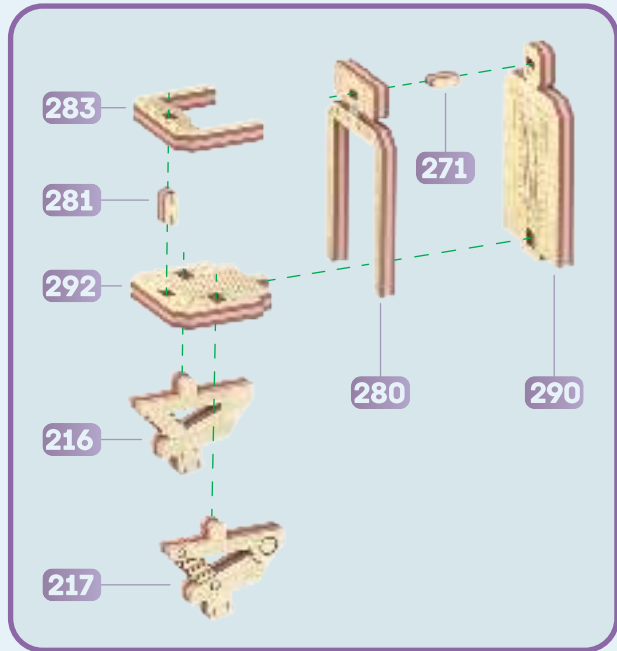

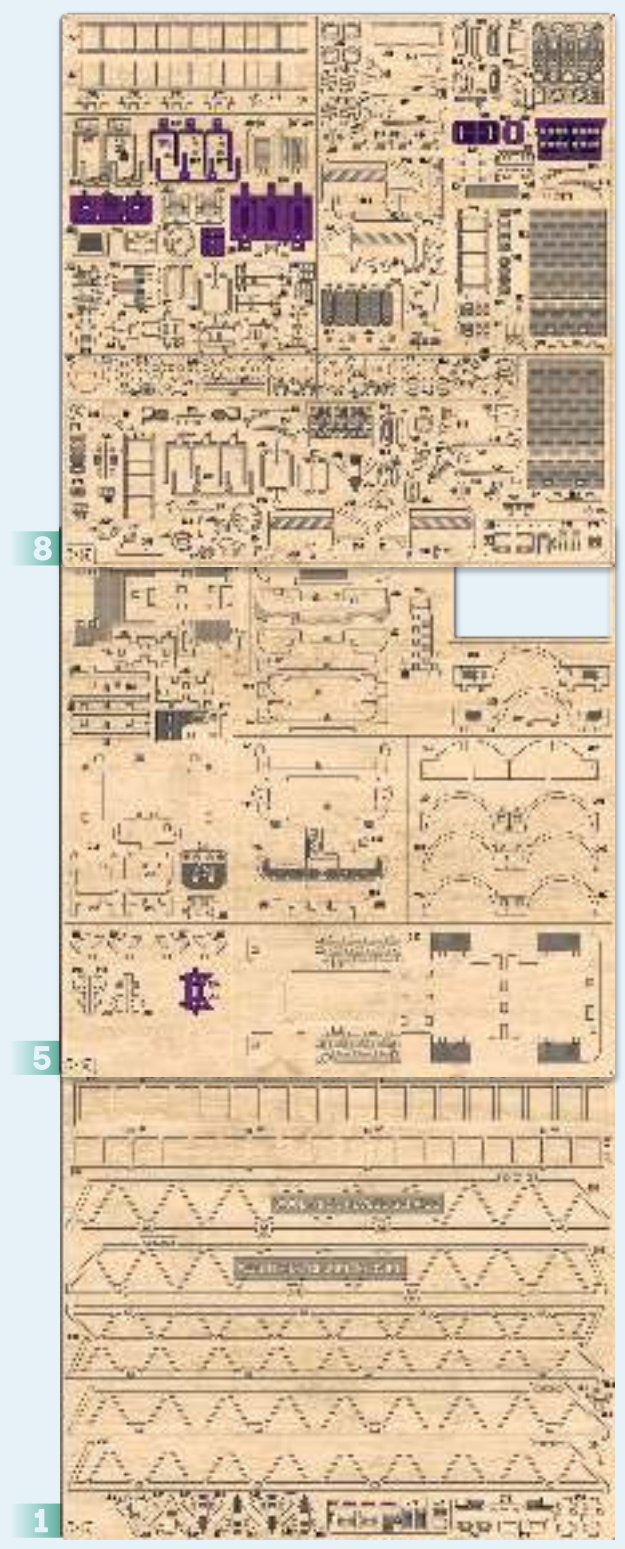
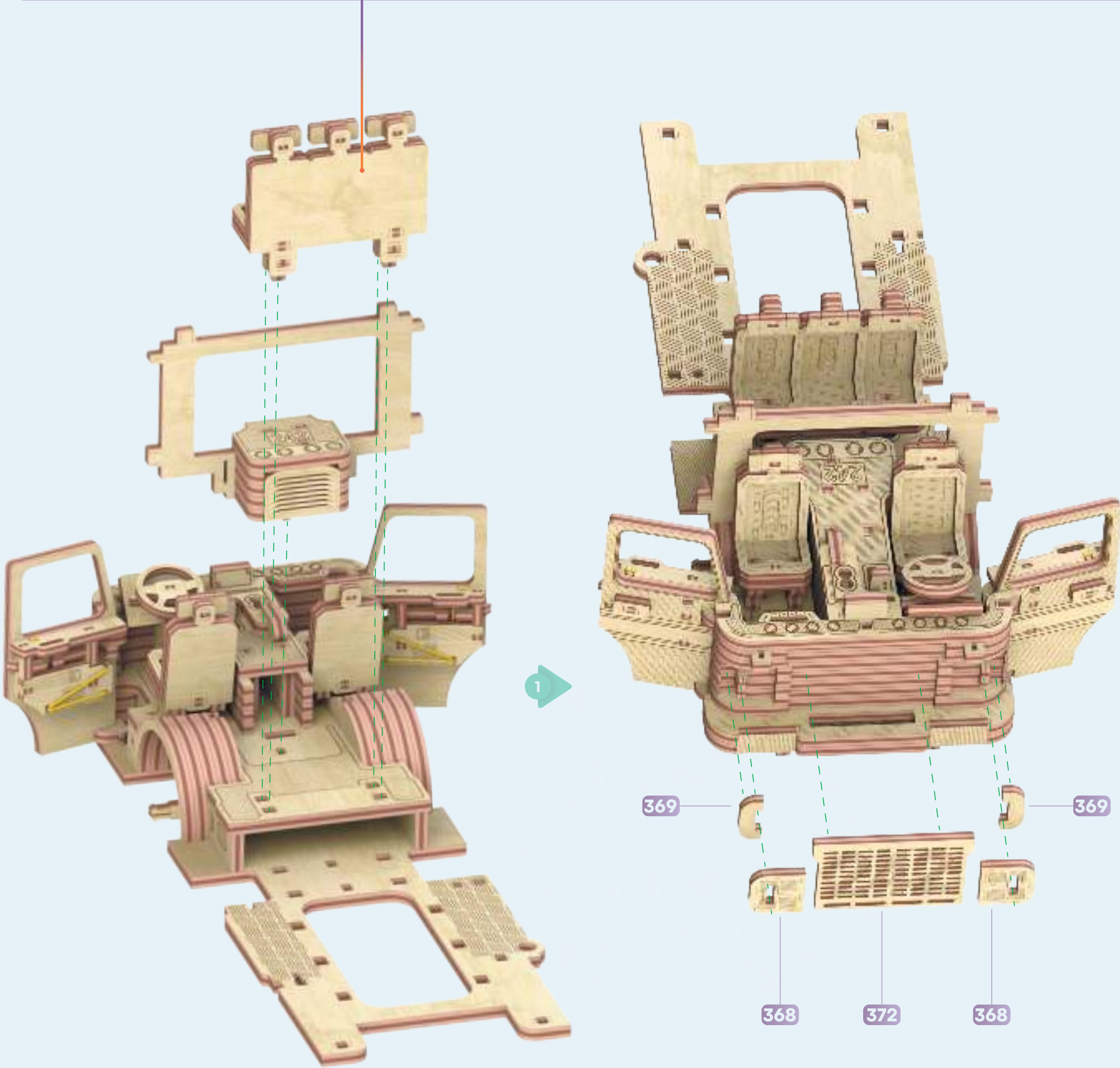
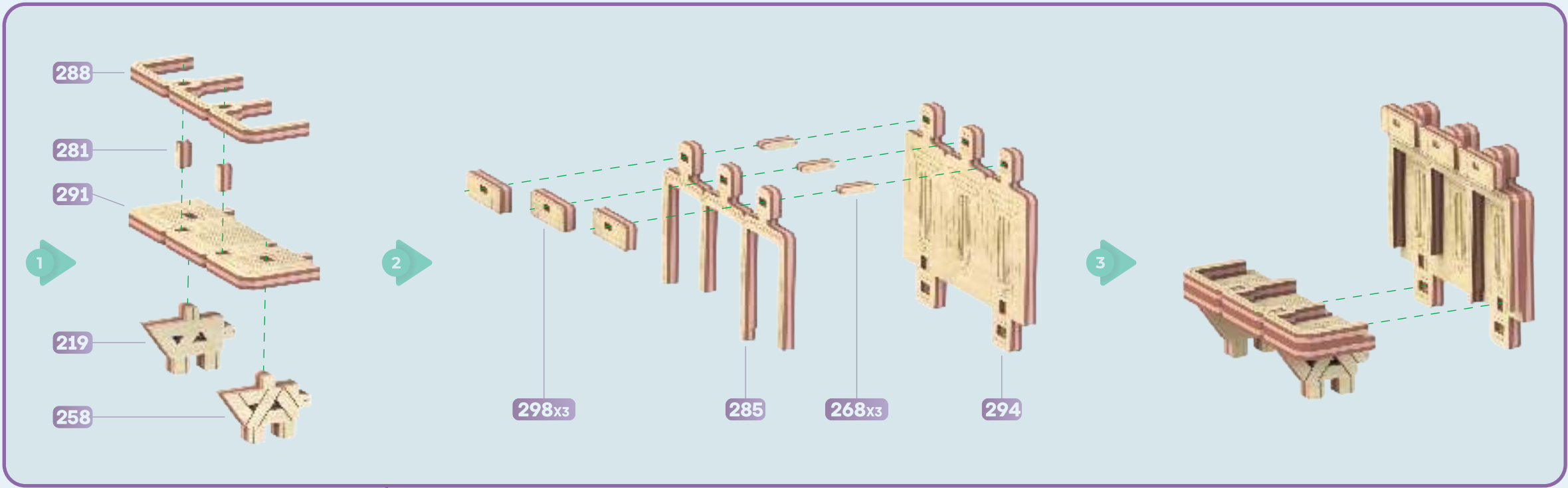

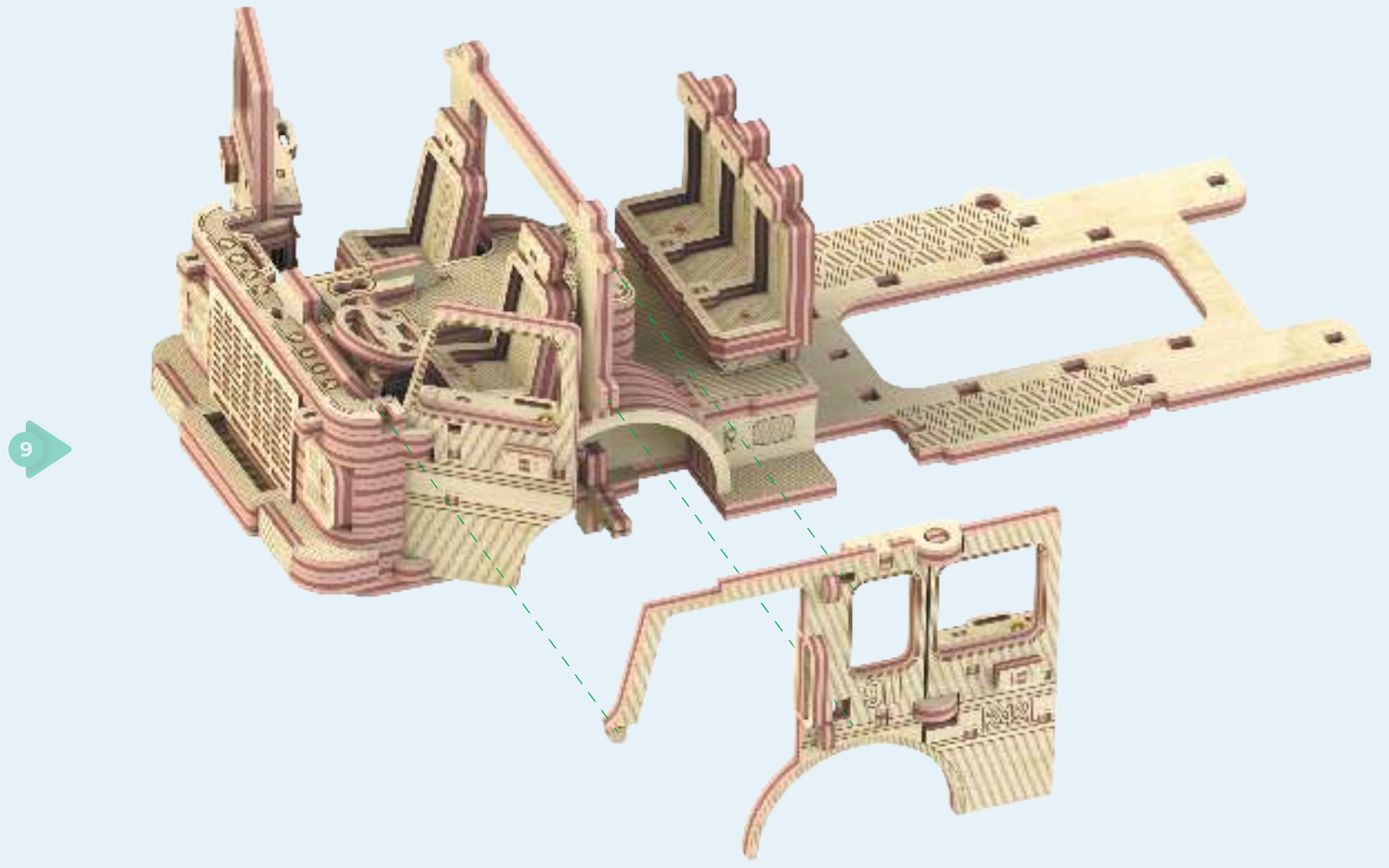
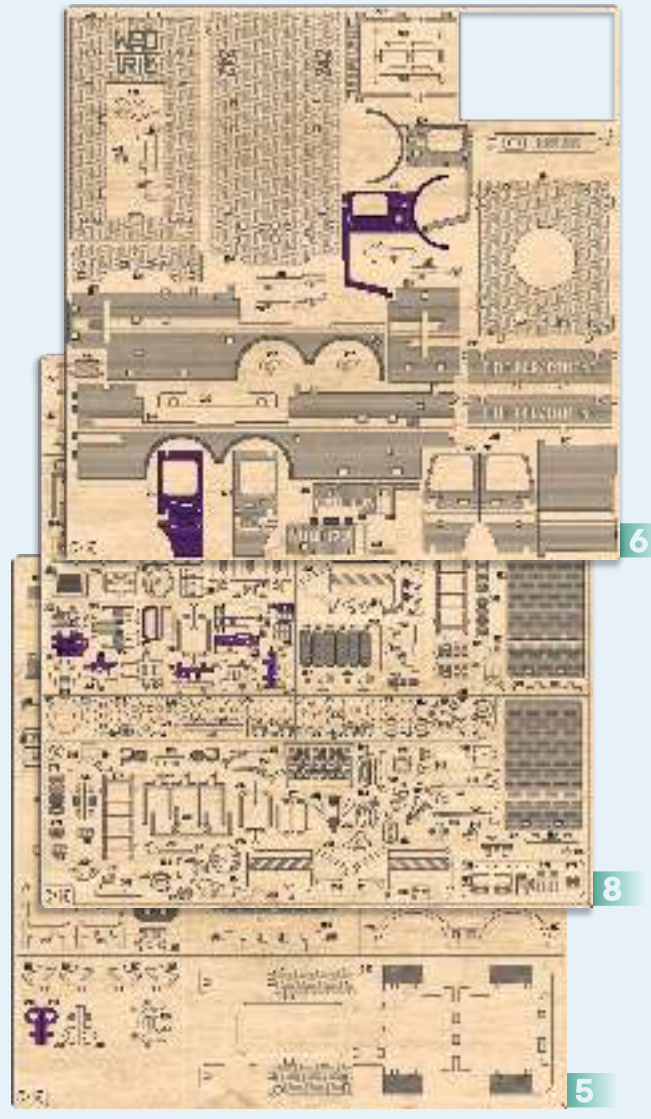
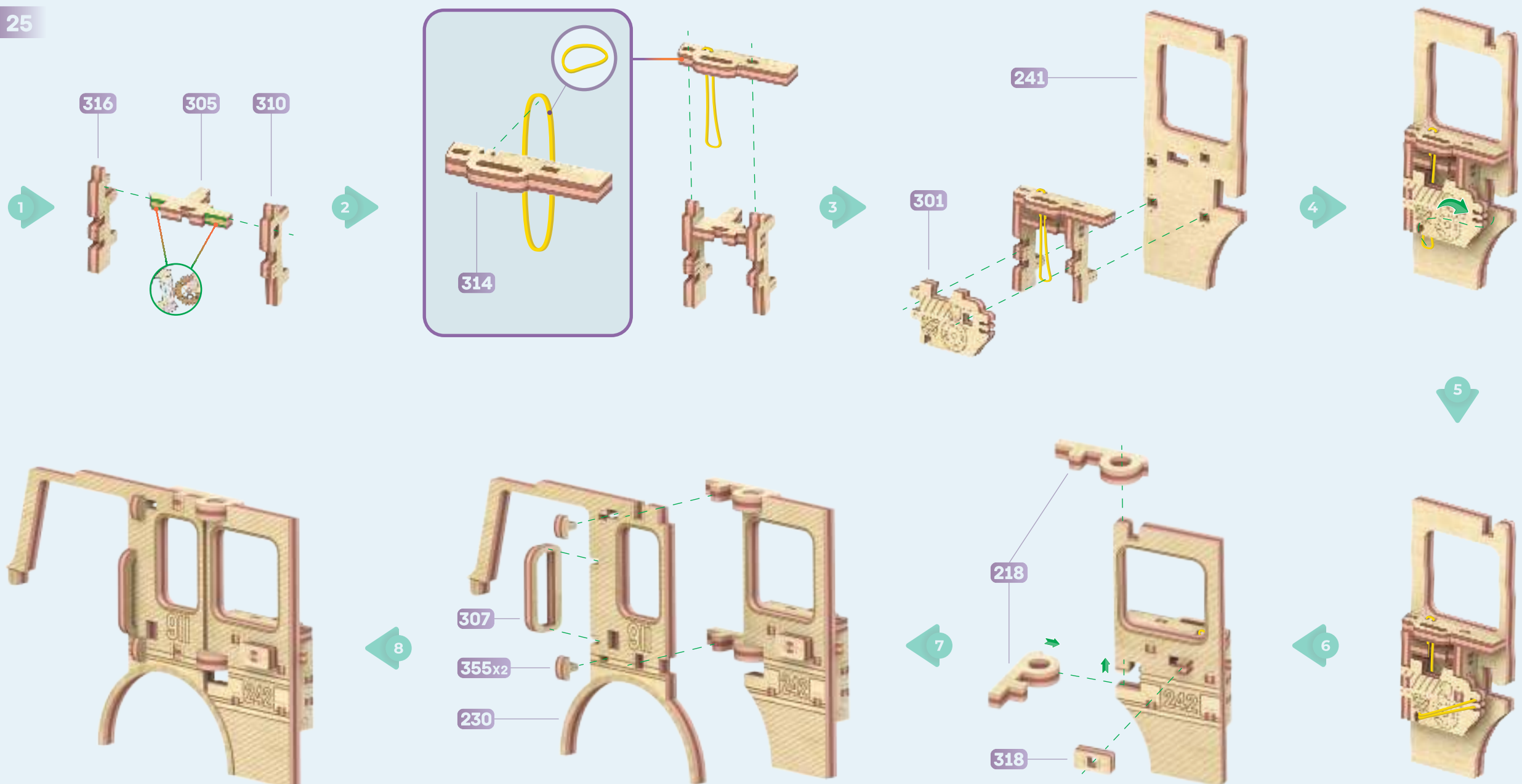

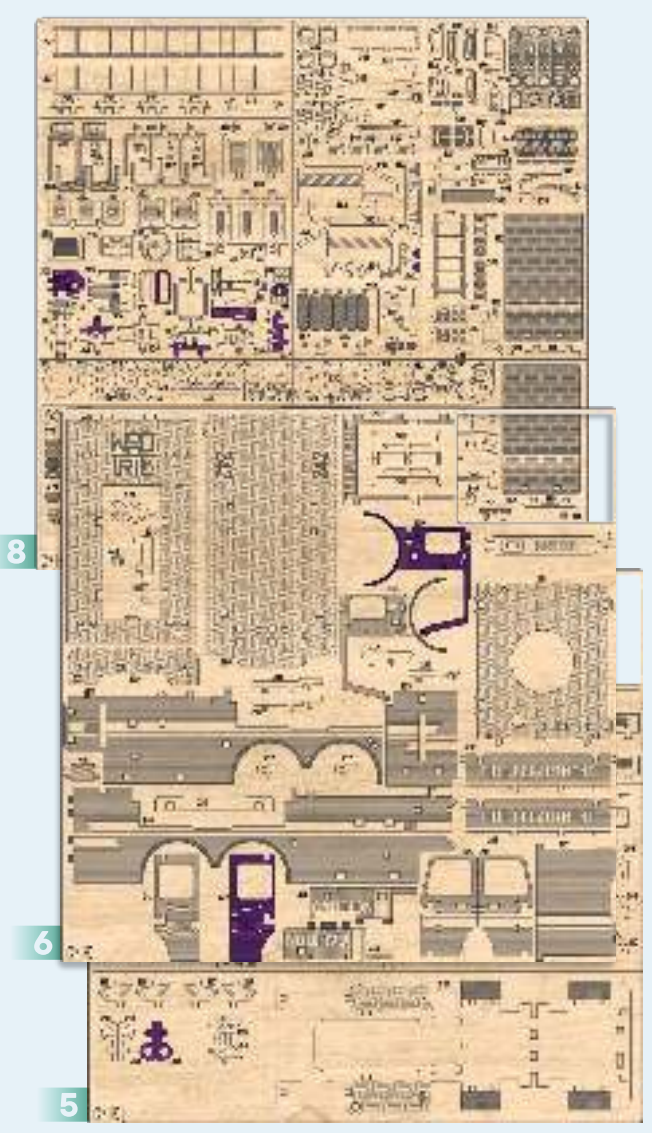
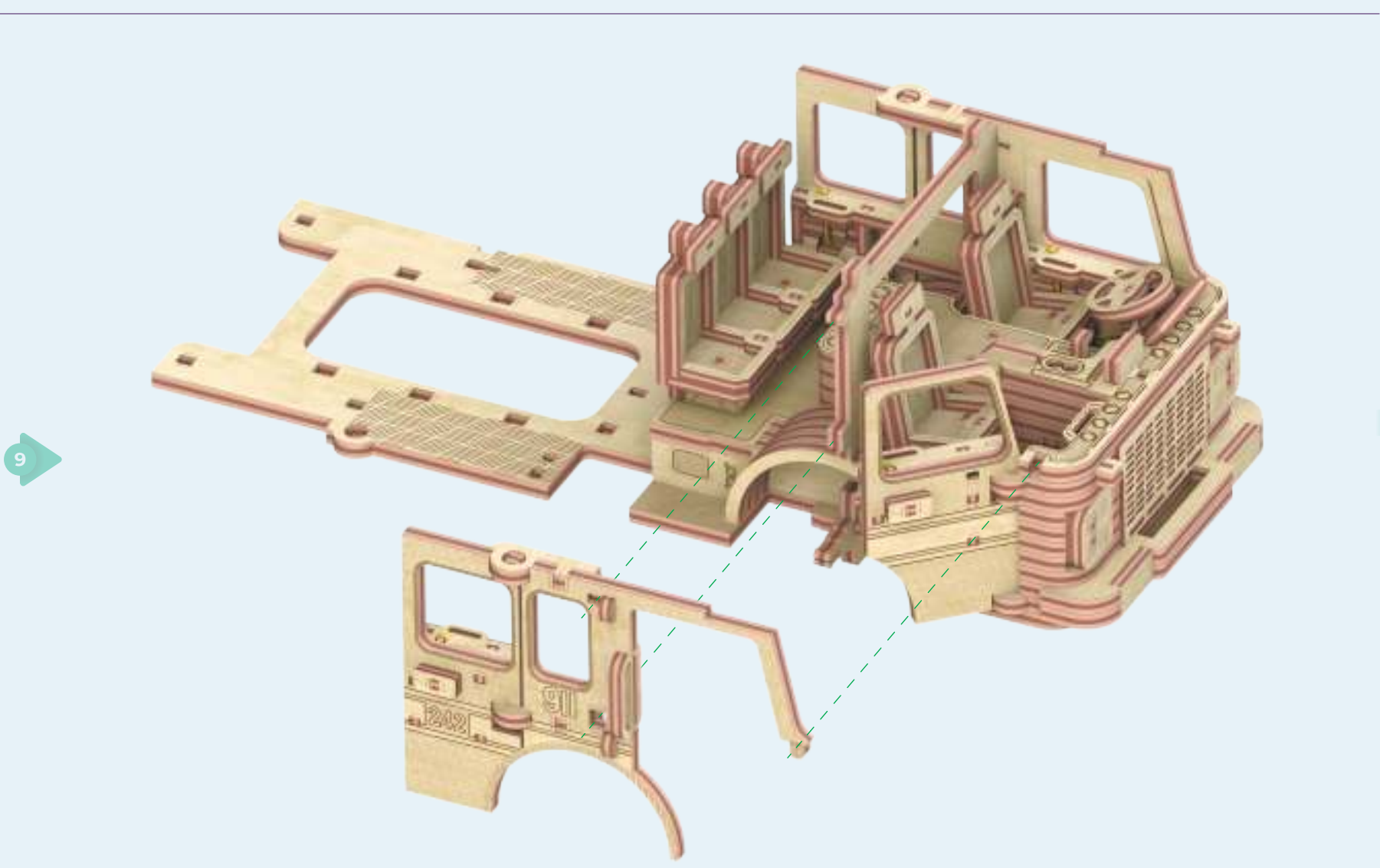
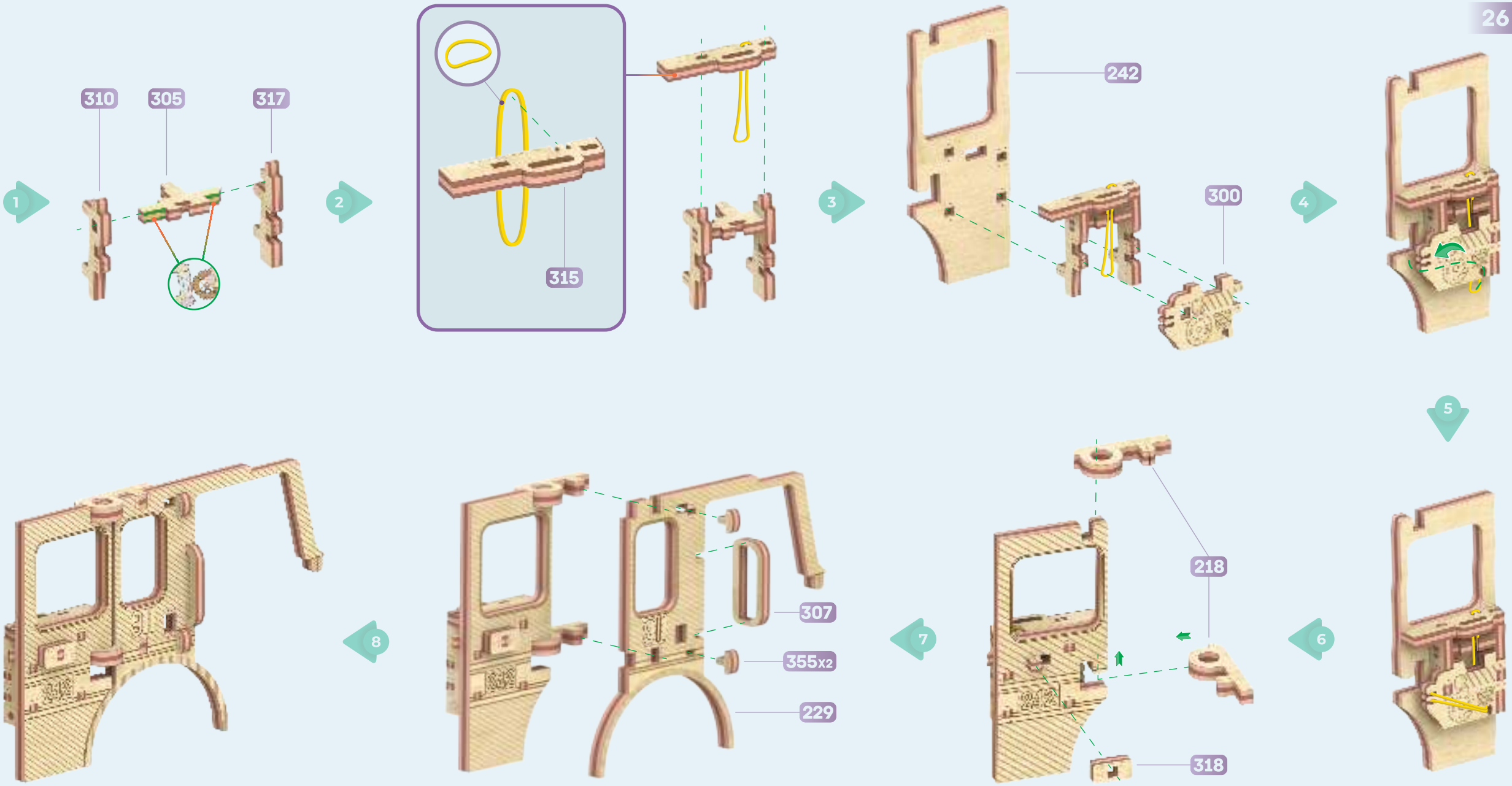

1

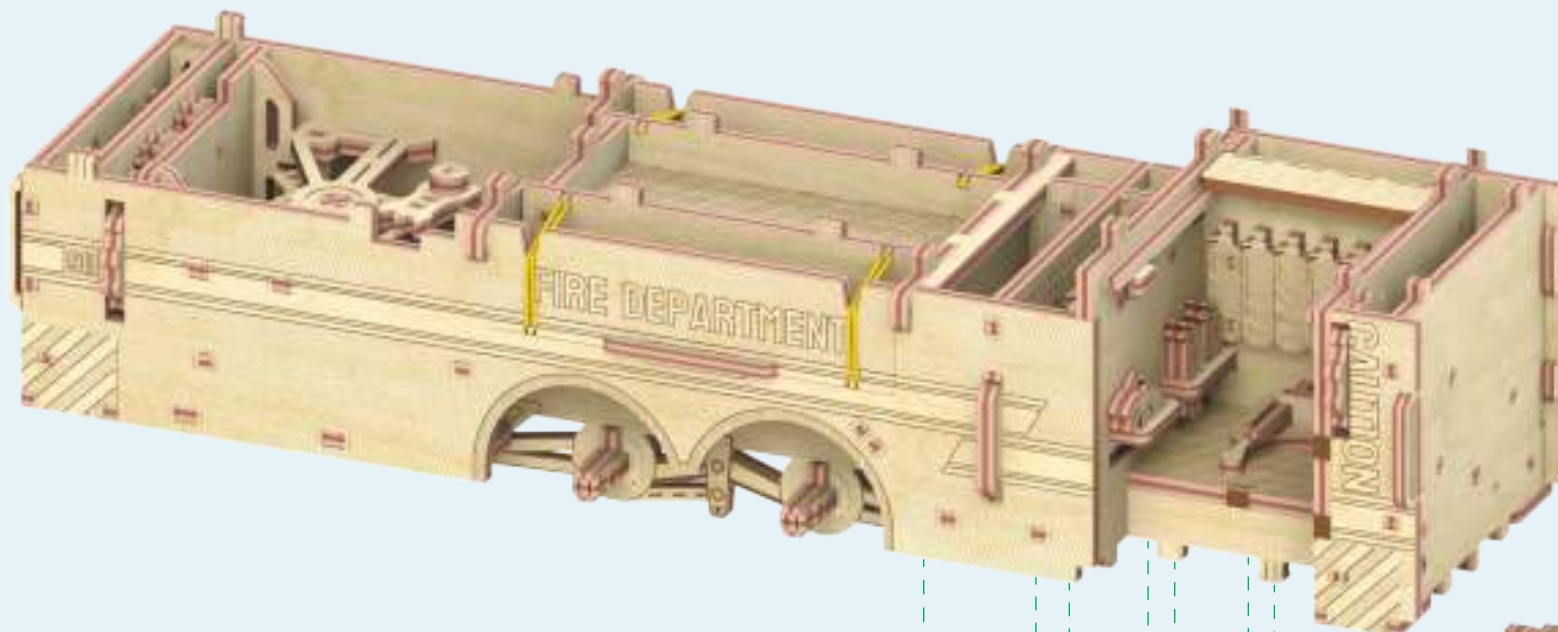

2

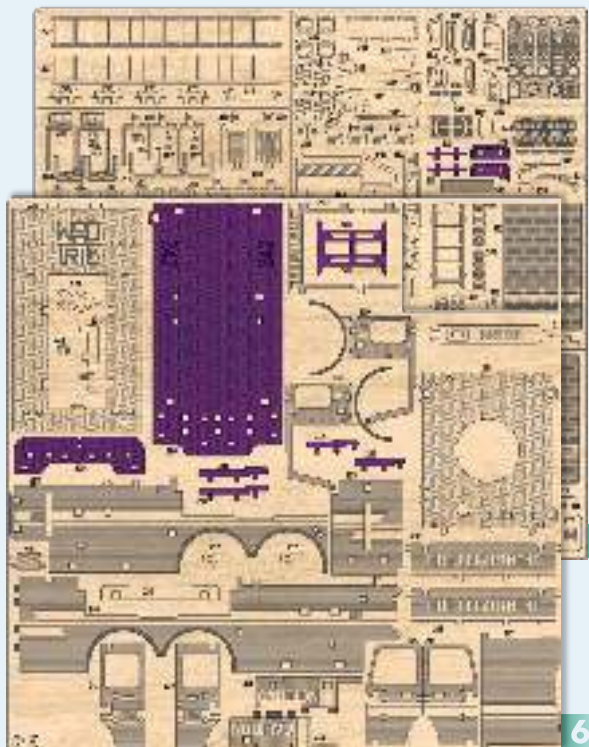
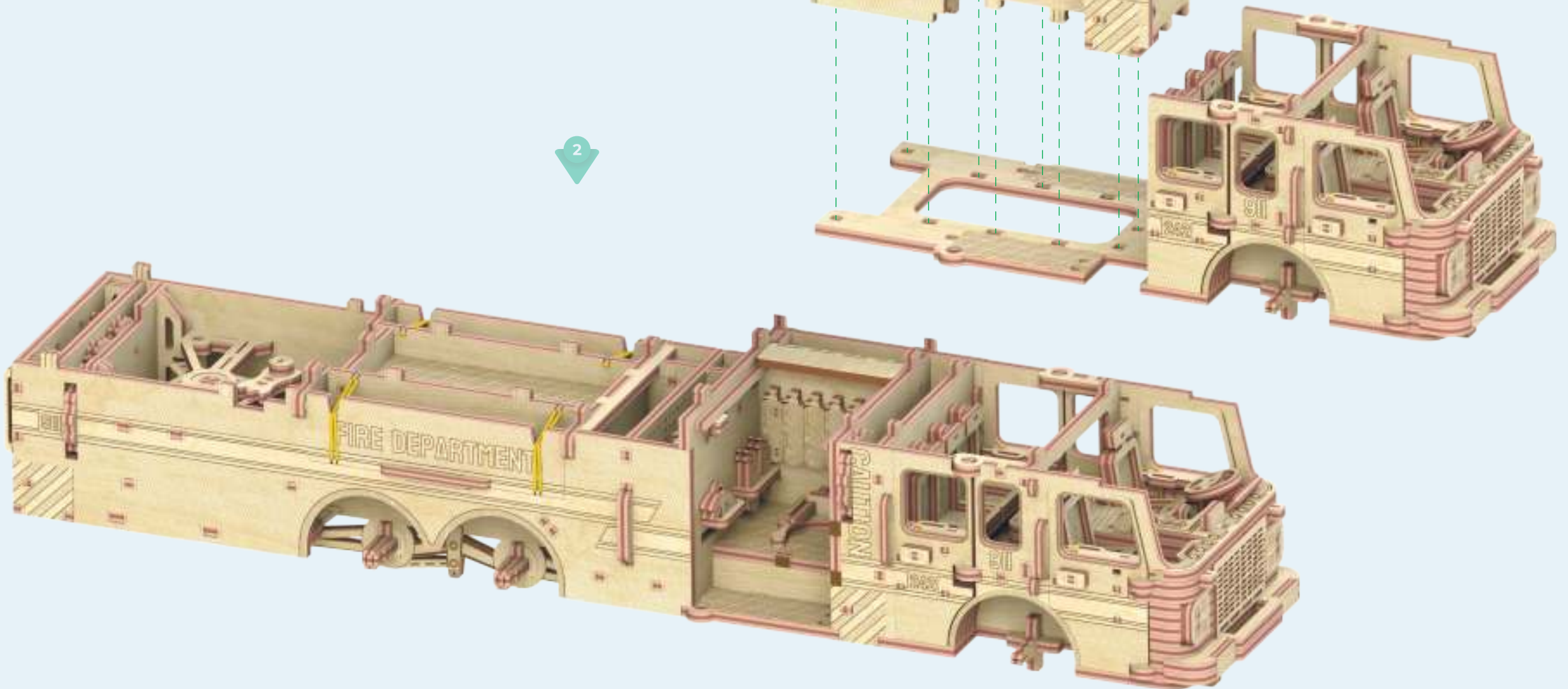

1

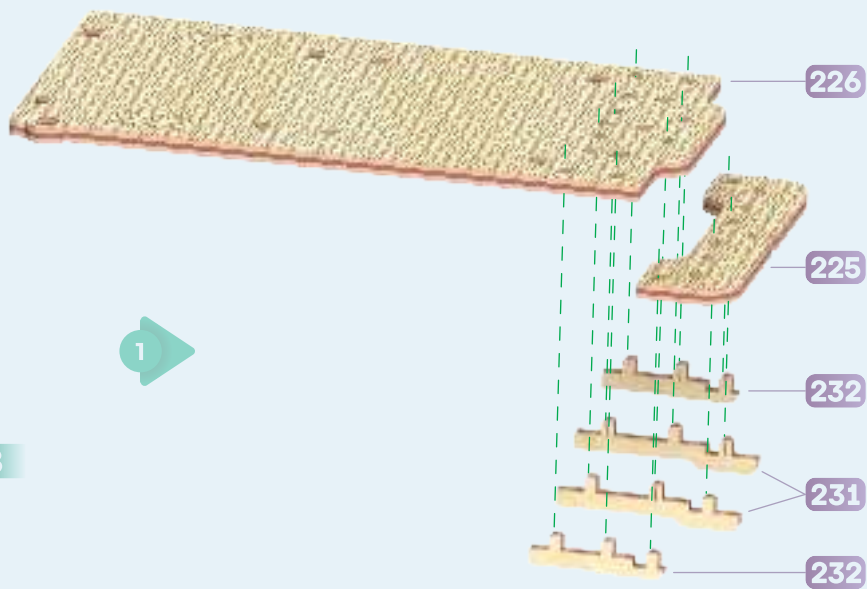

2

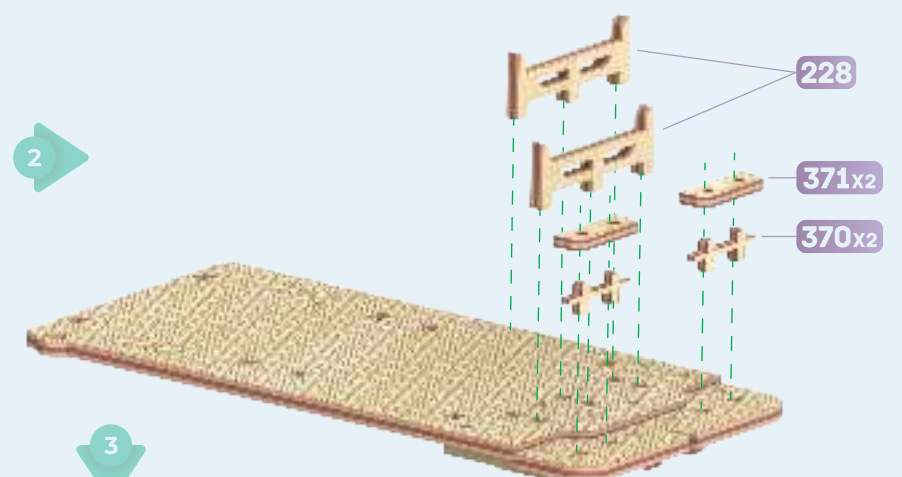

3

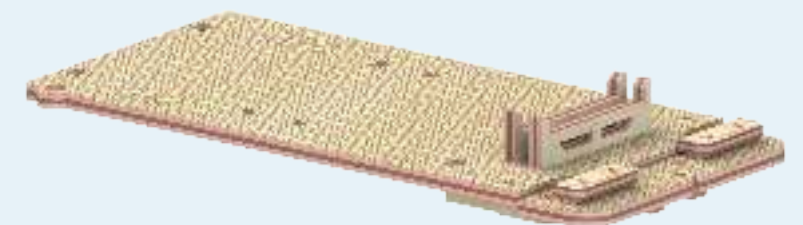

1

247

279

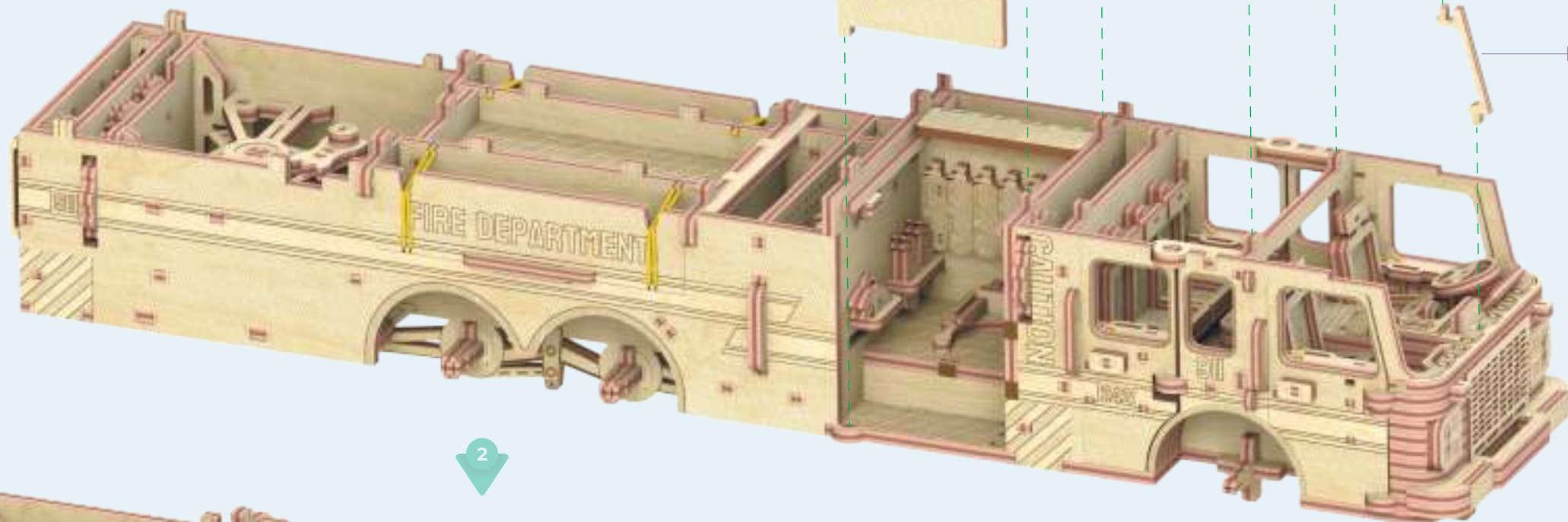

2

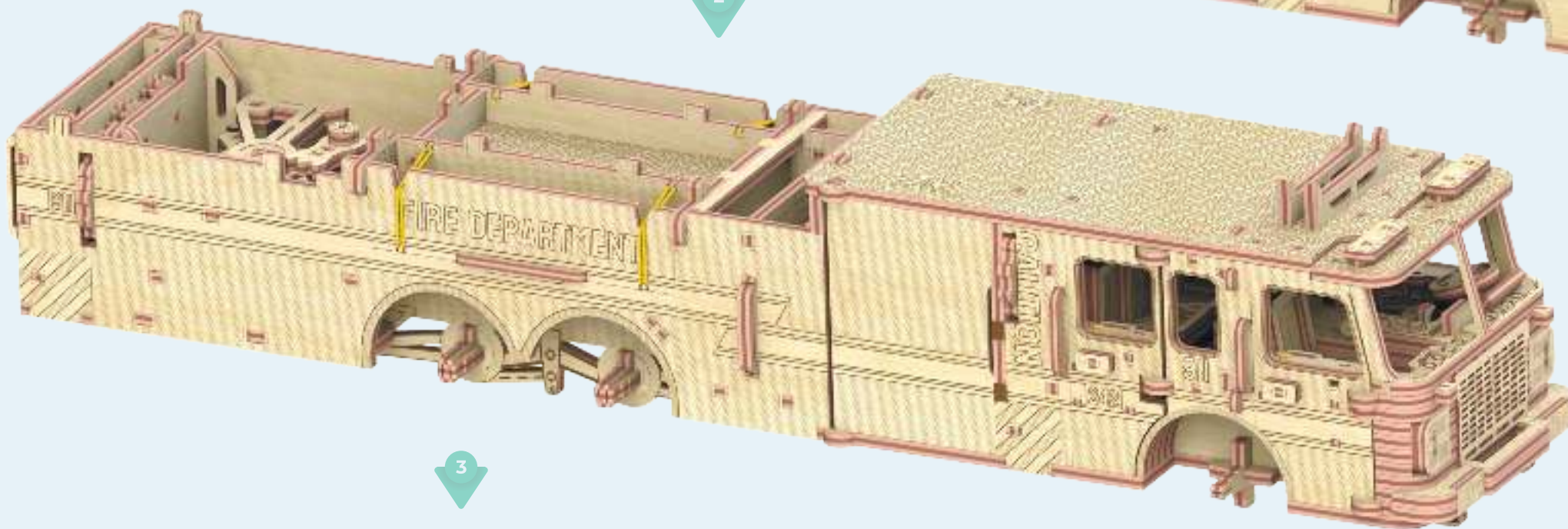

3

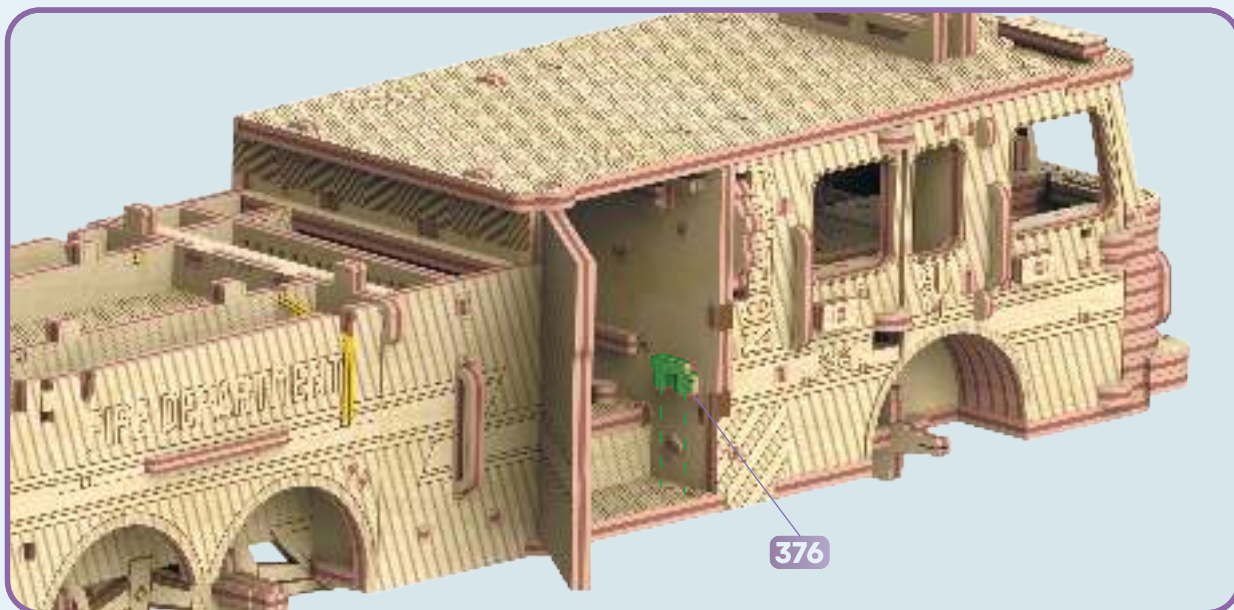

376

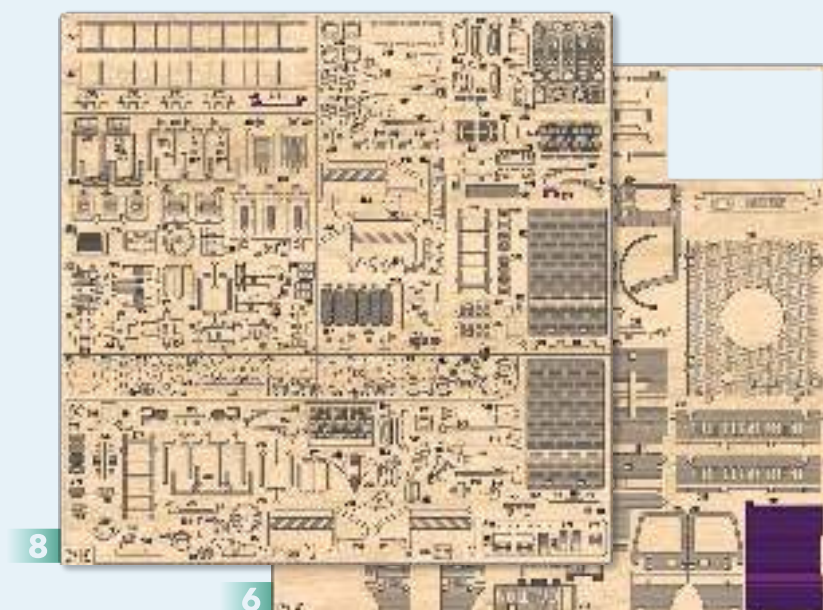

8

6

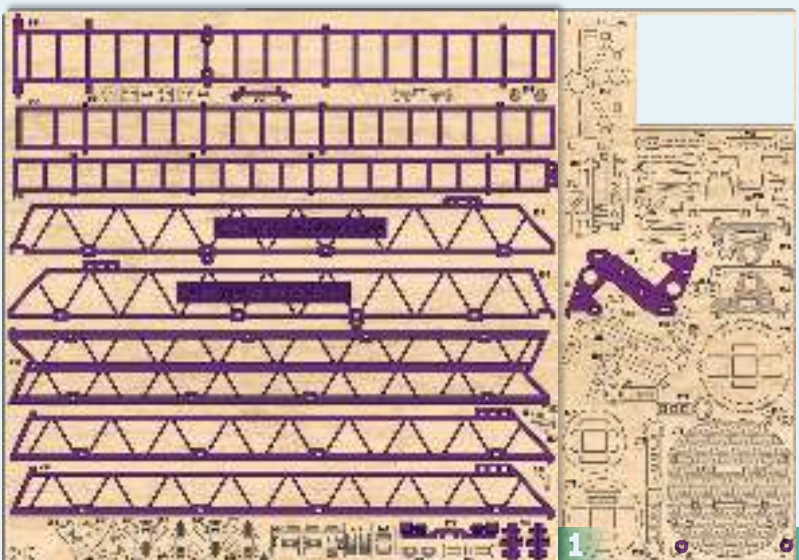
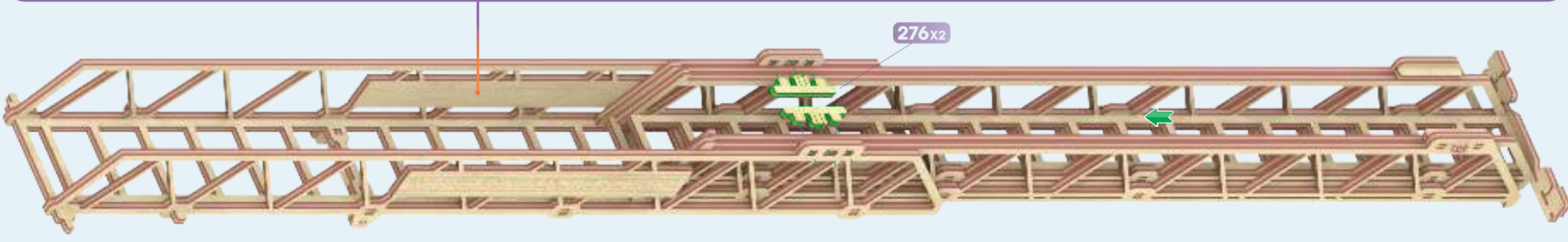
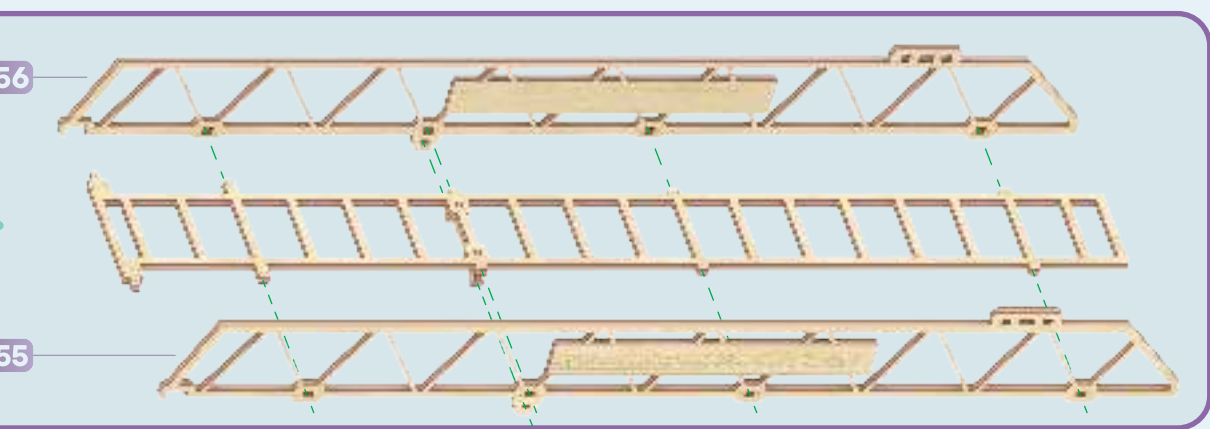
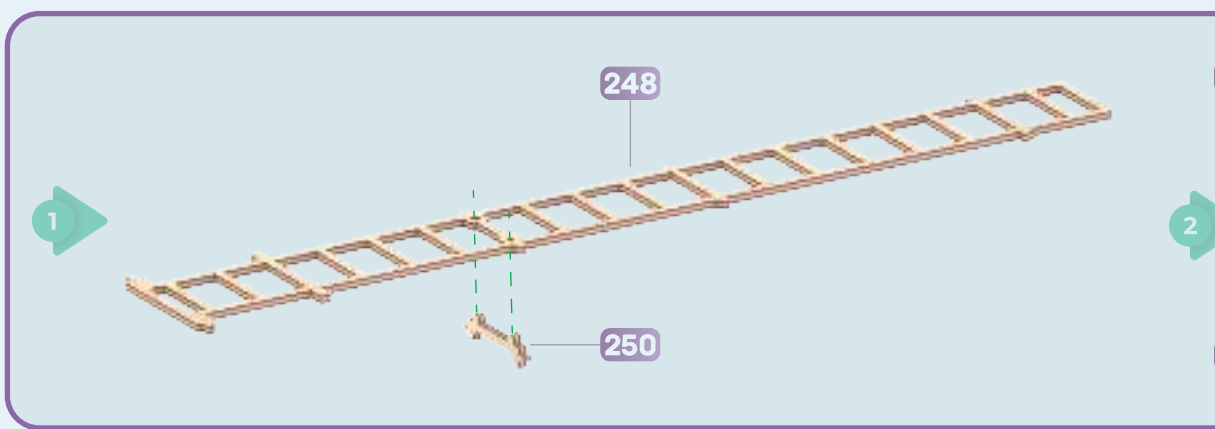
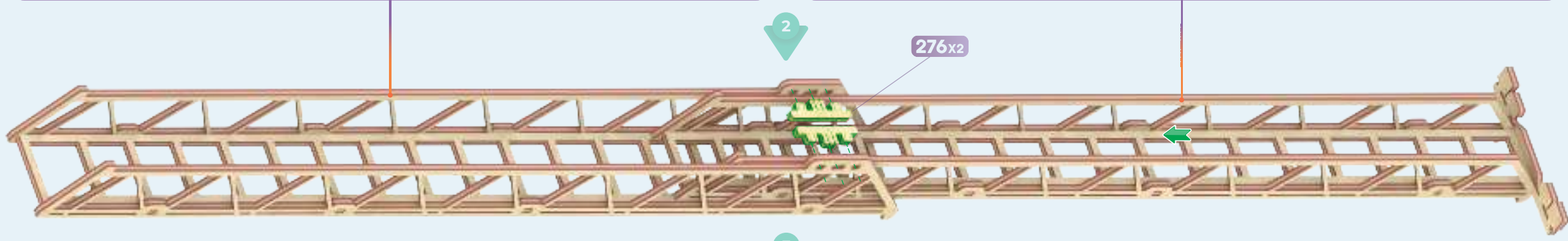
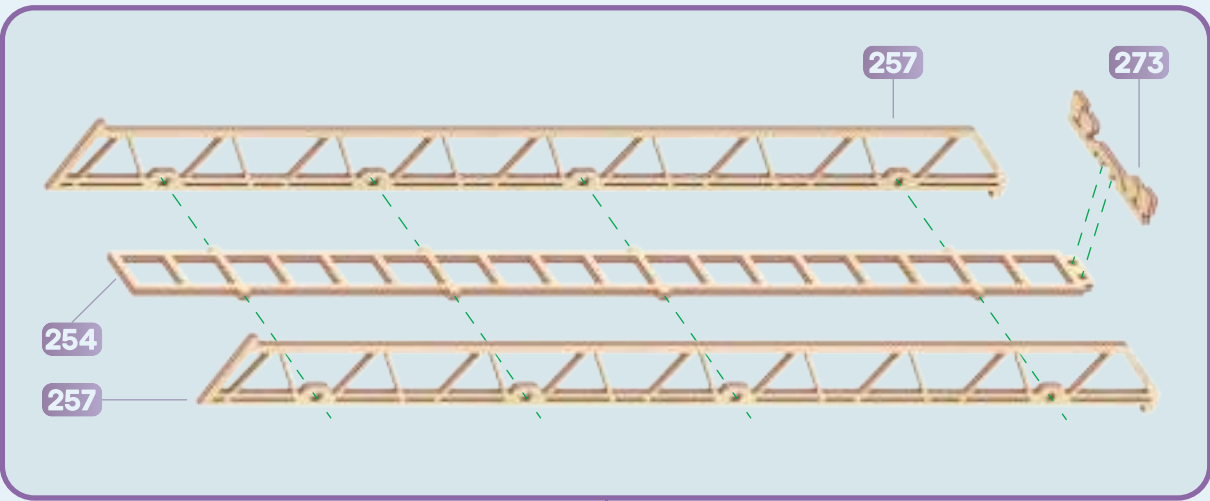
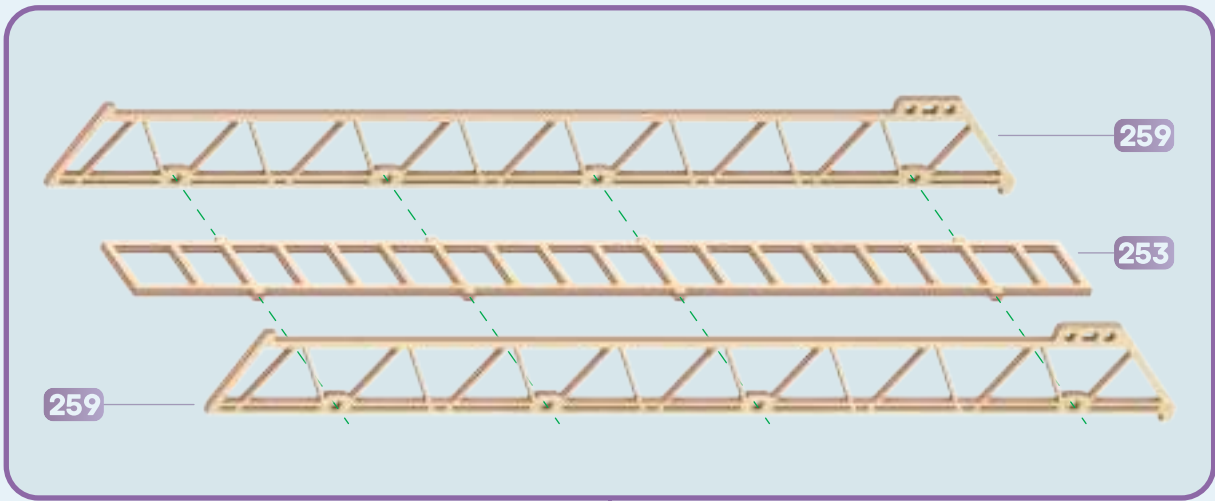

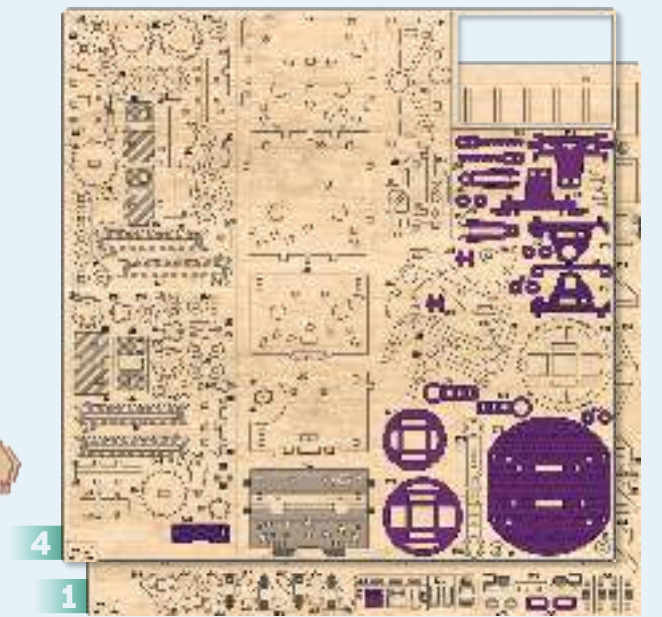
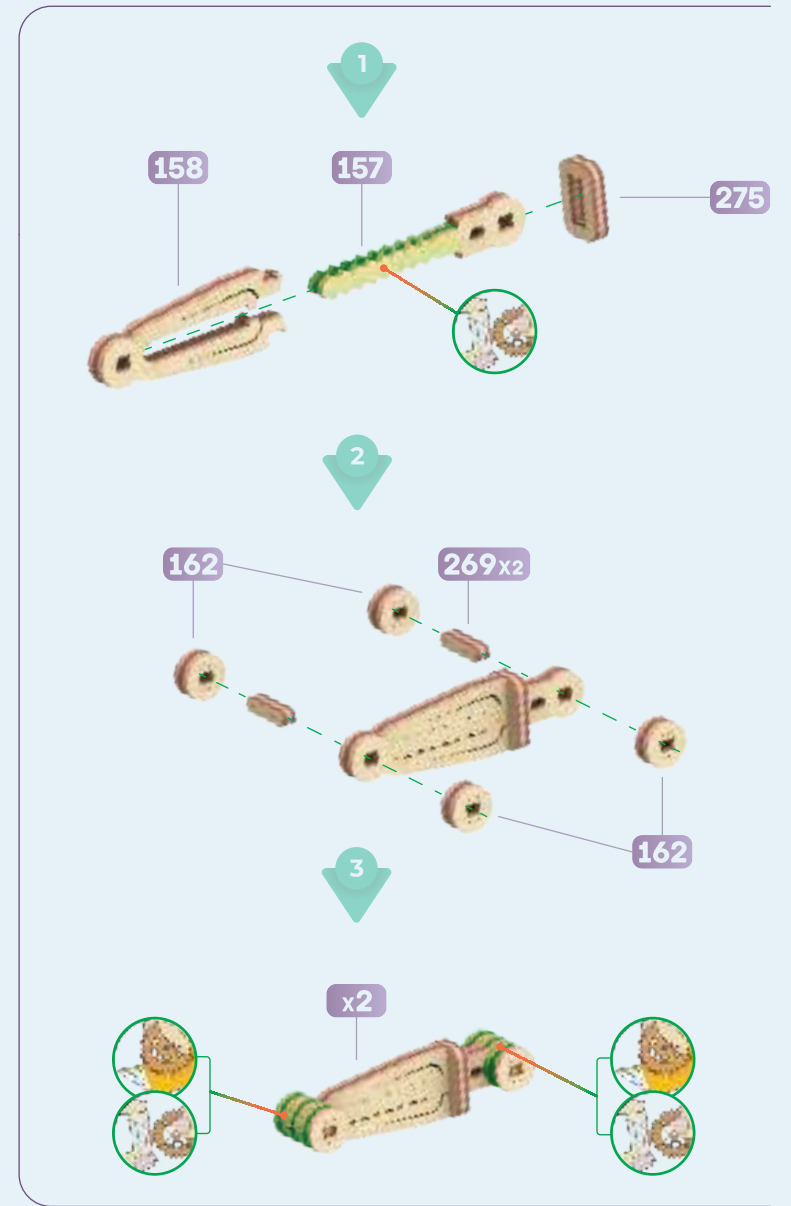
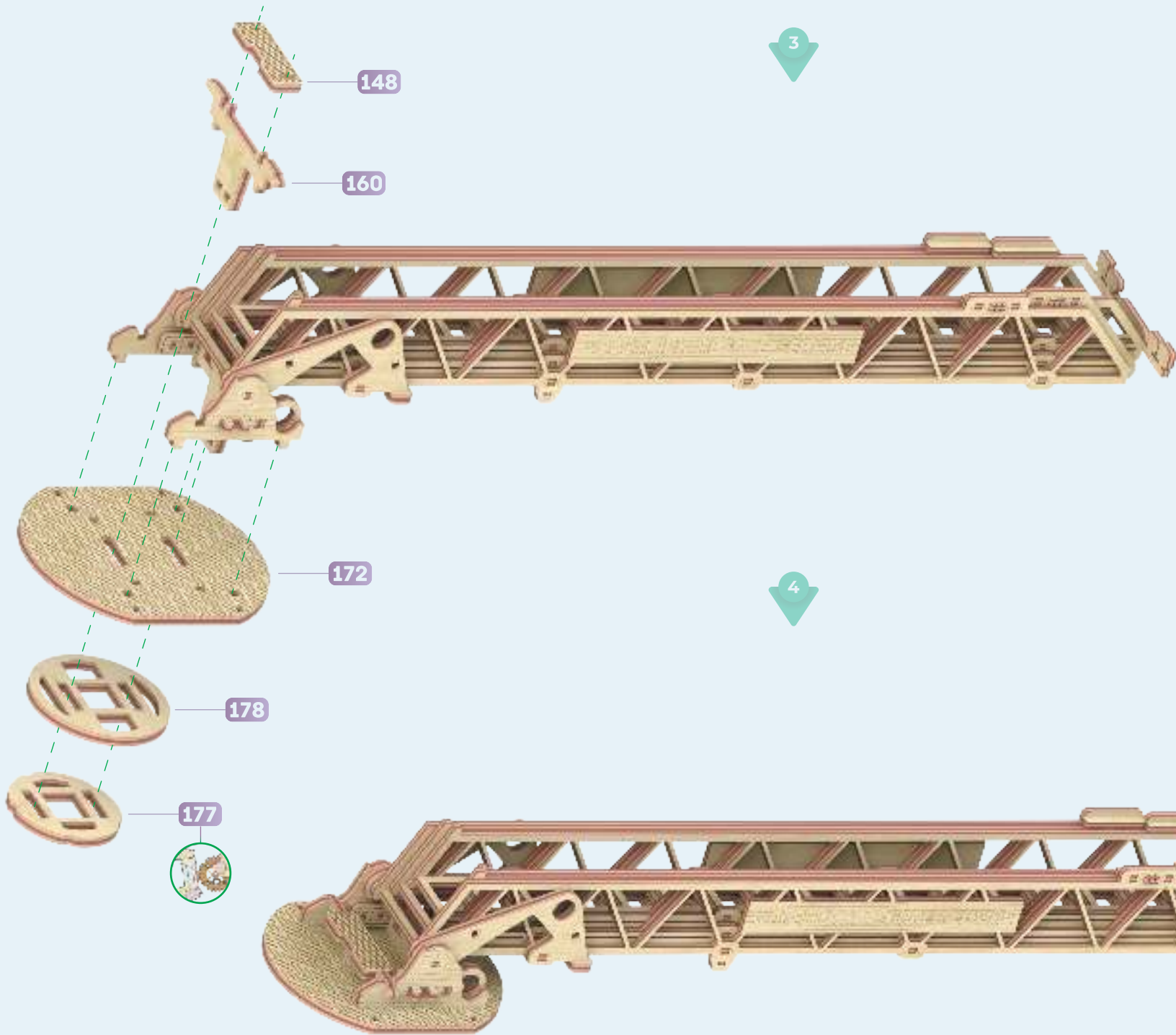
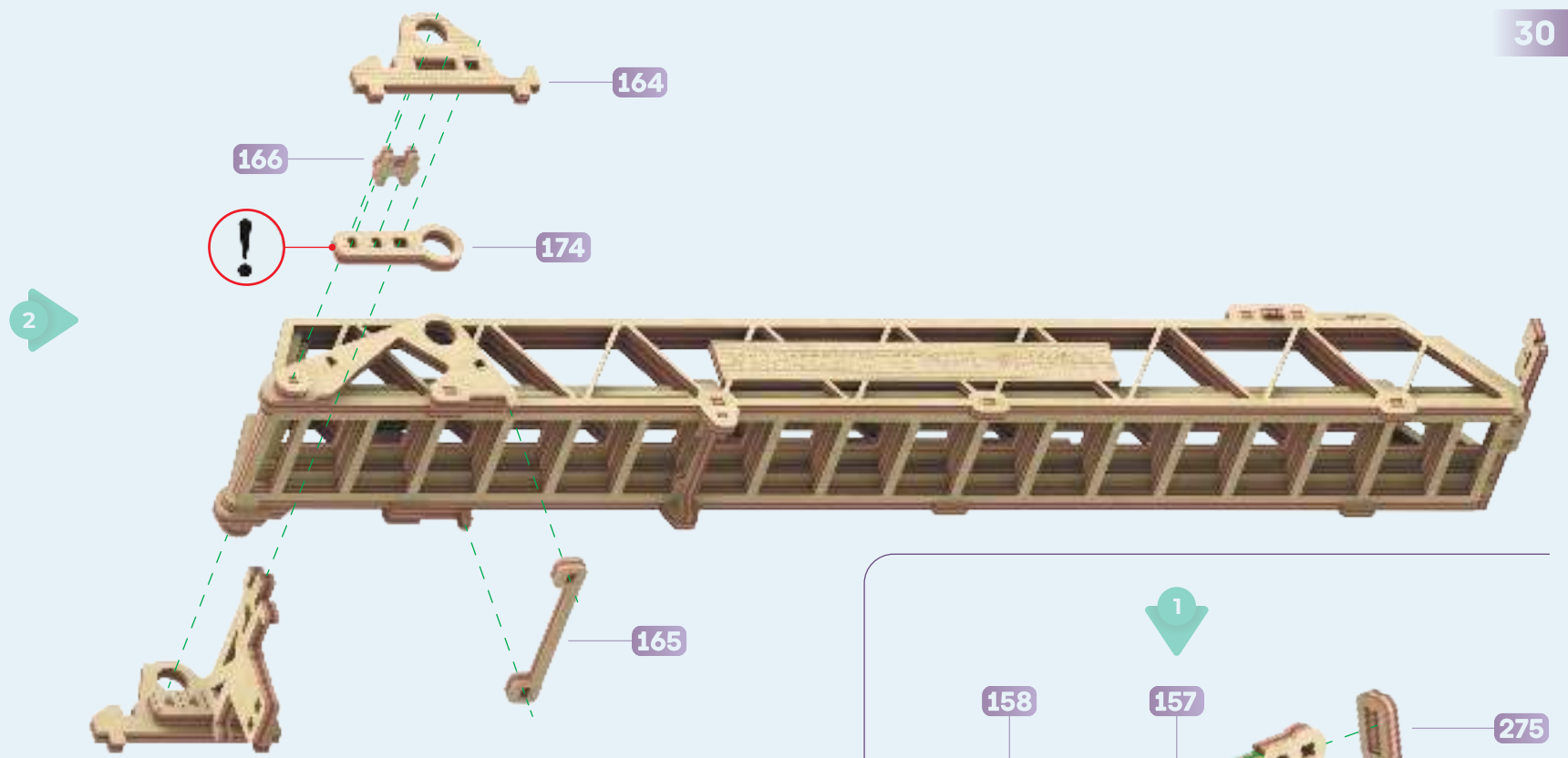
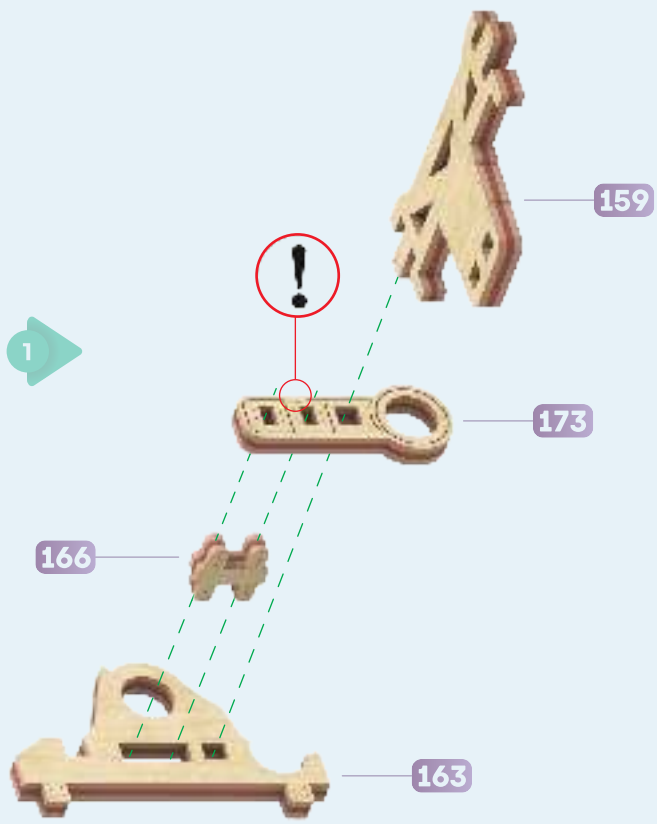

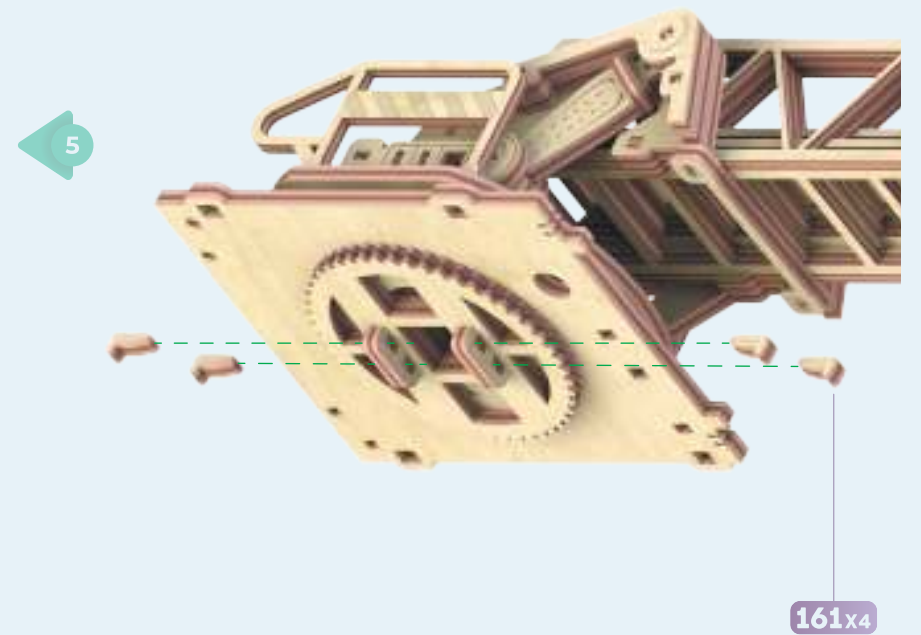
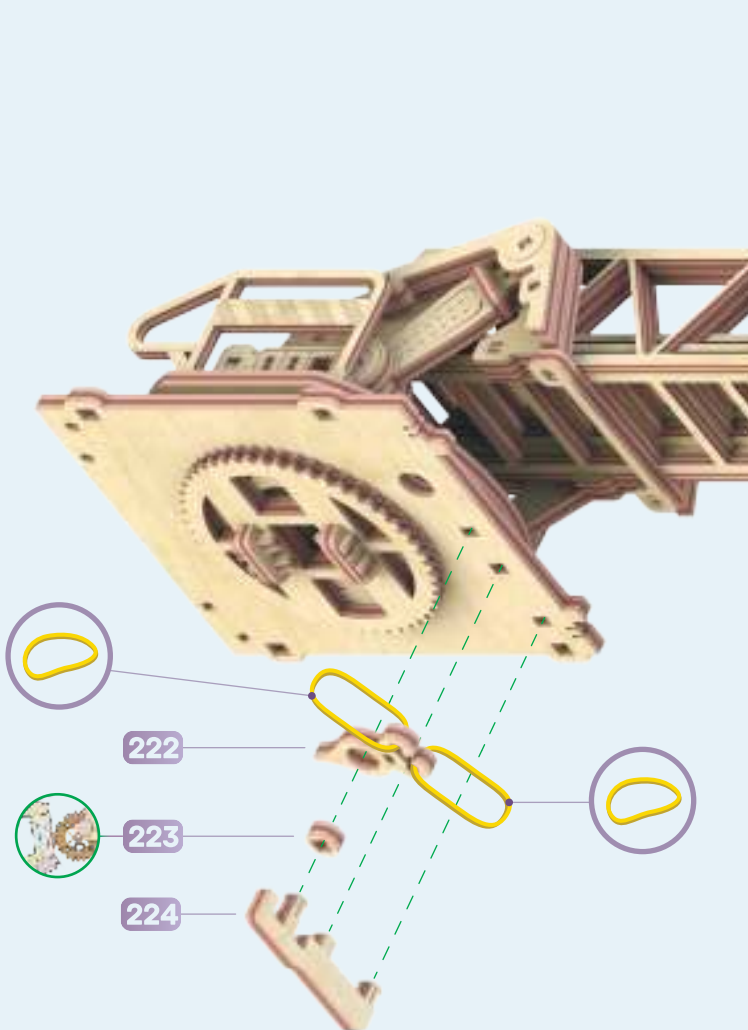
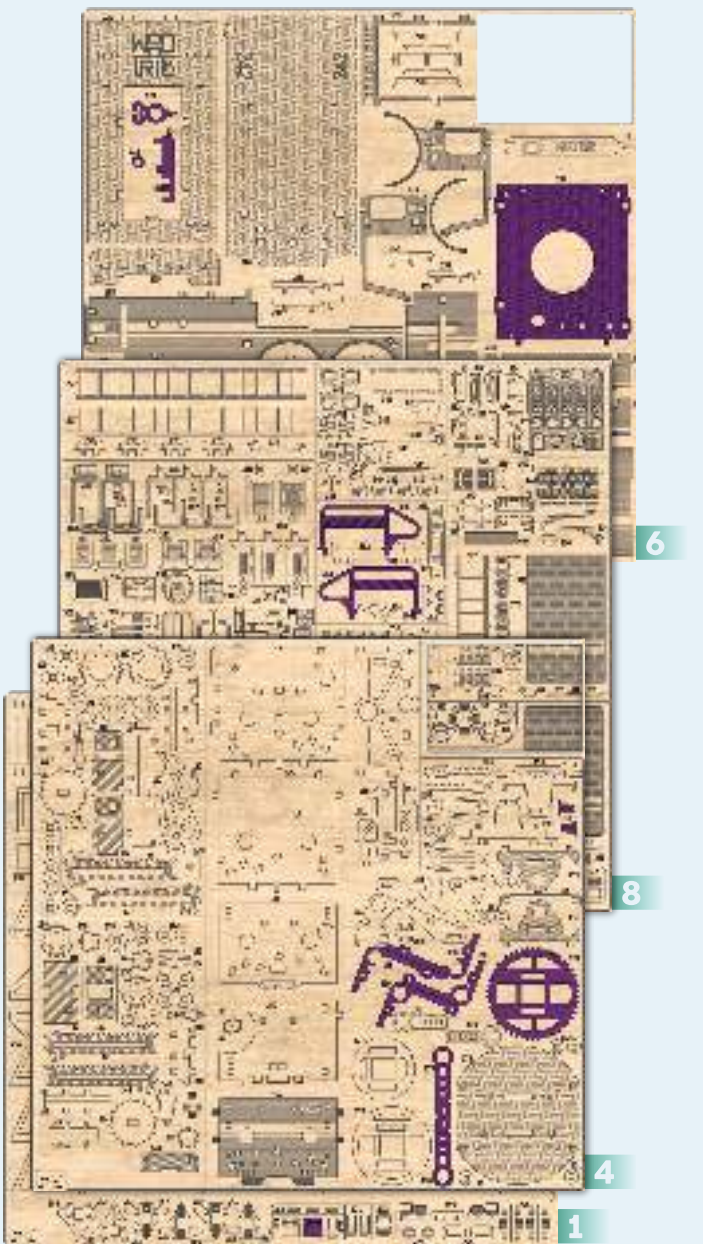
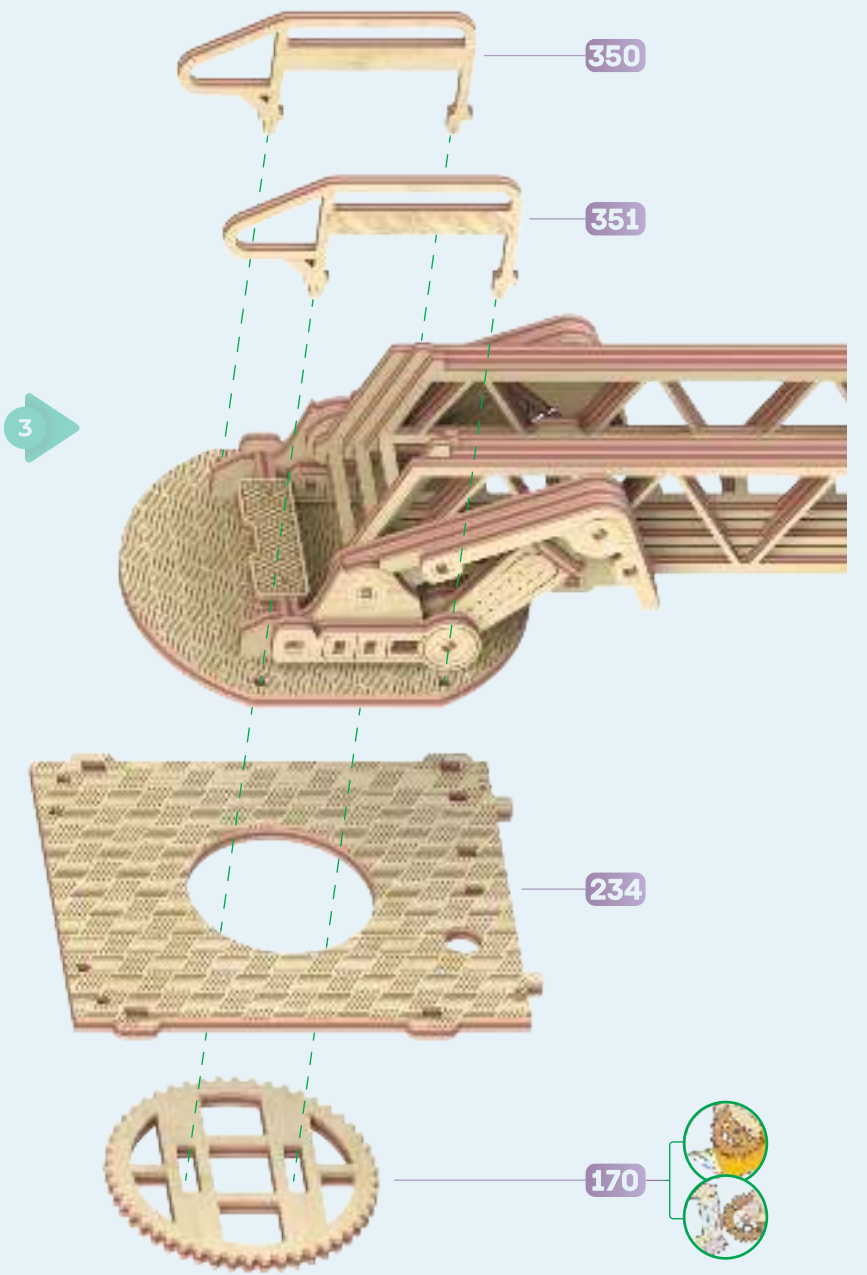
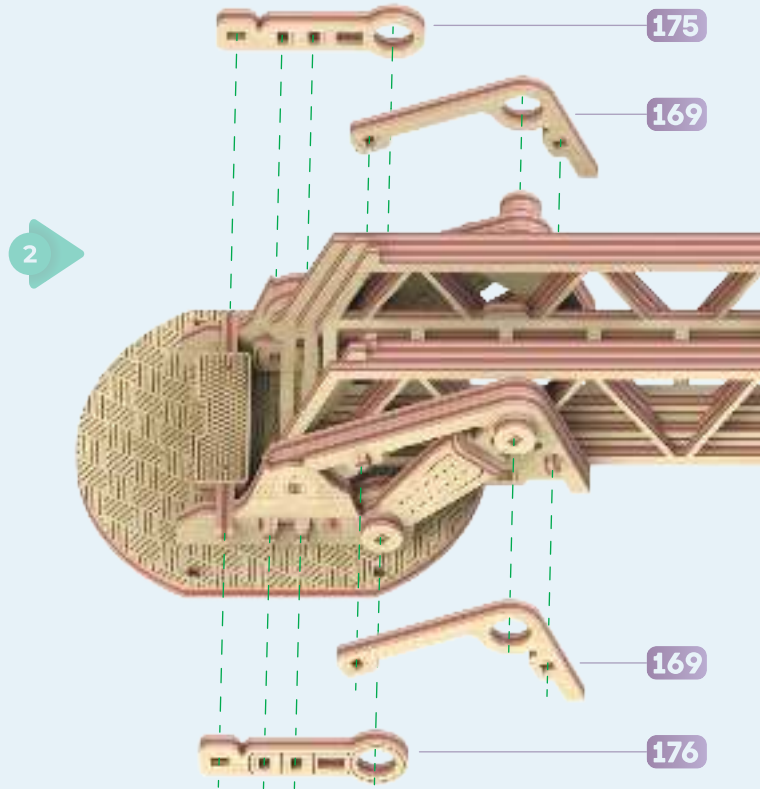
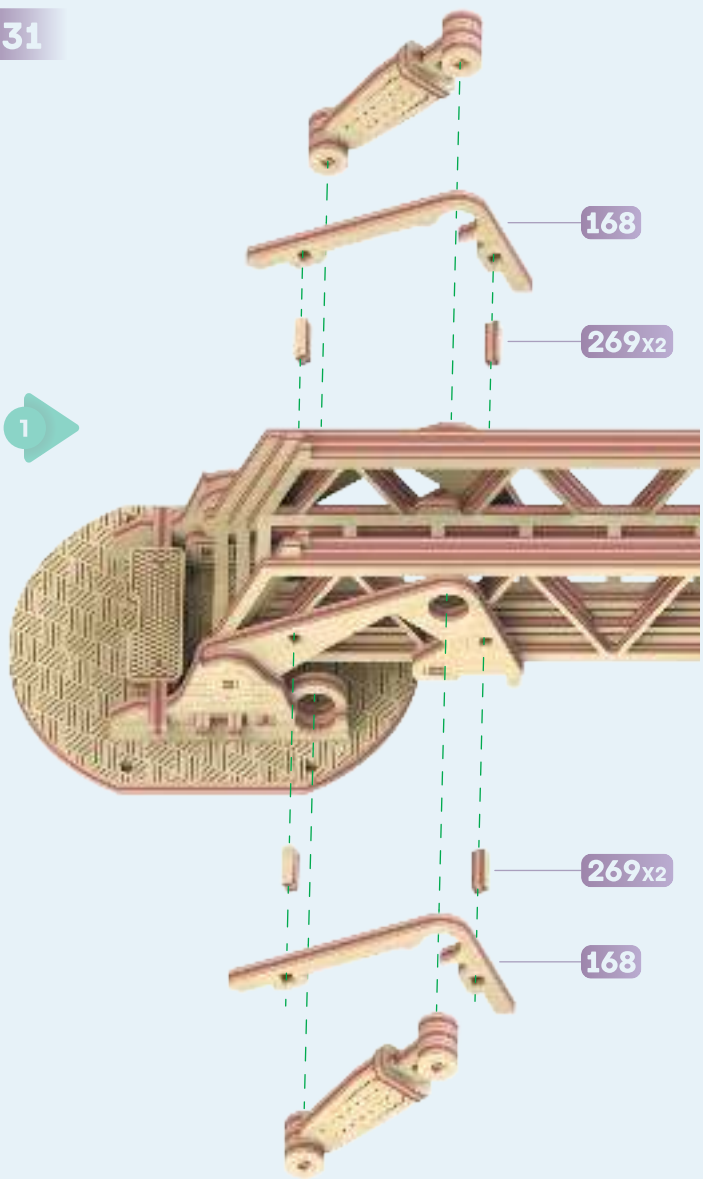

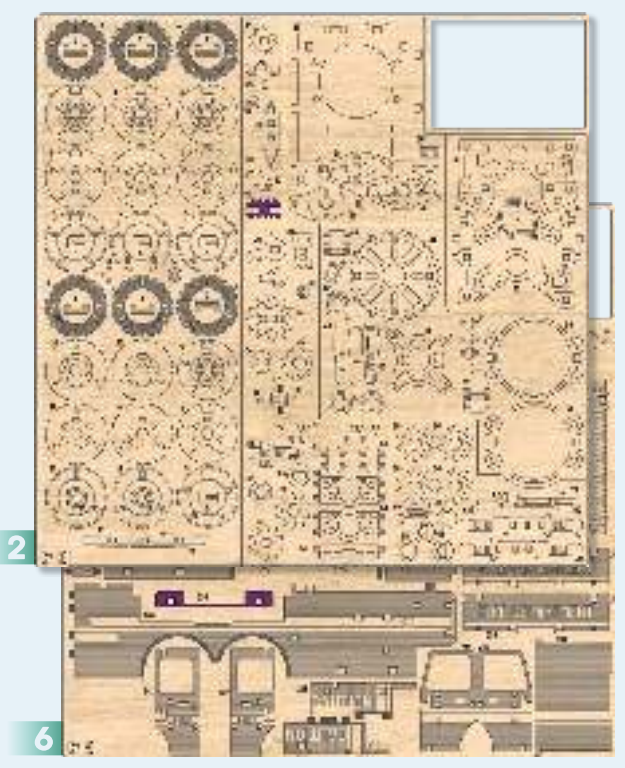
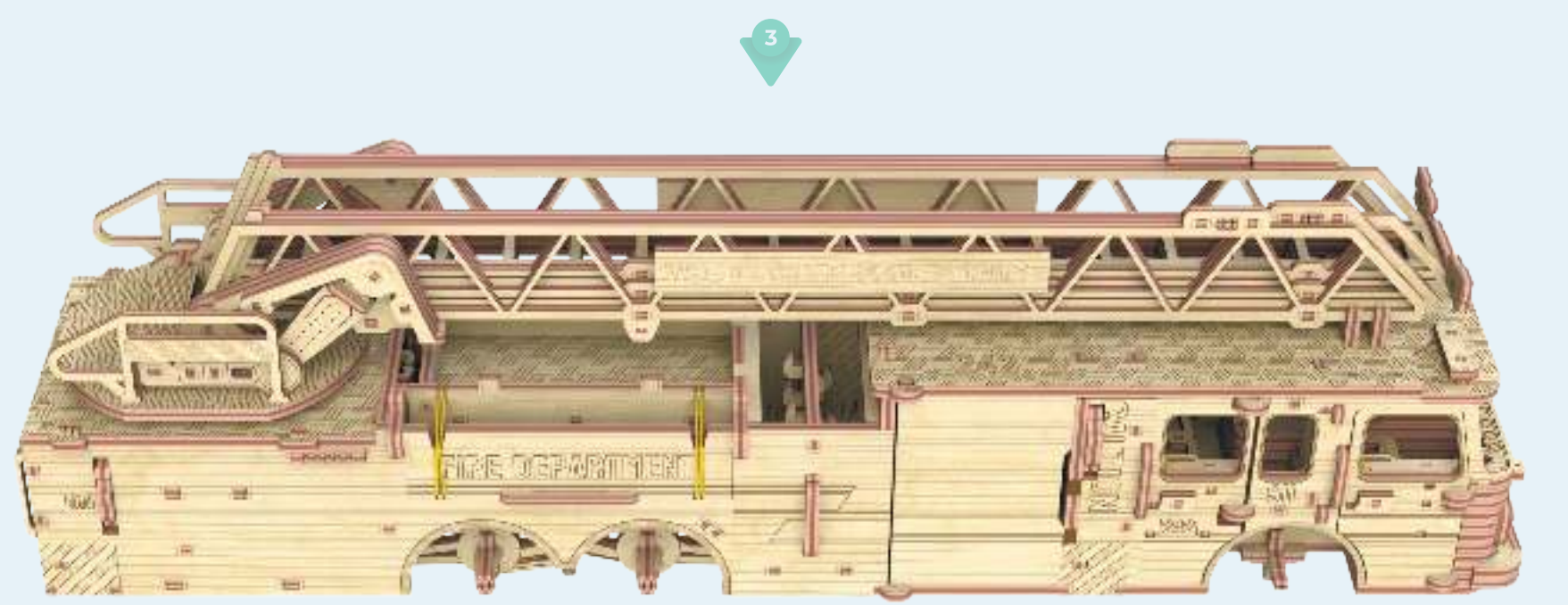
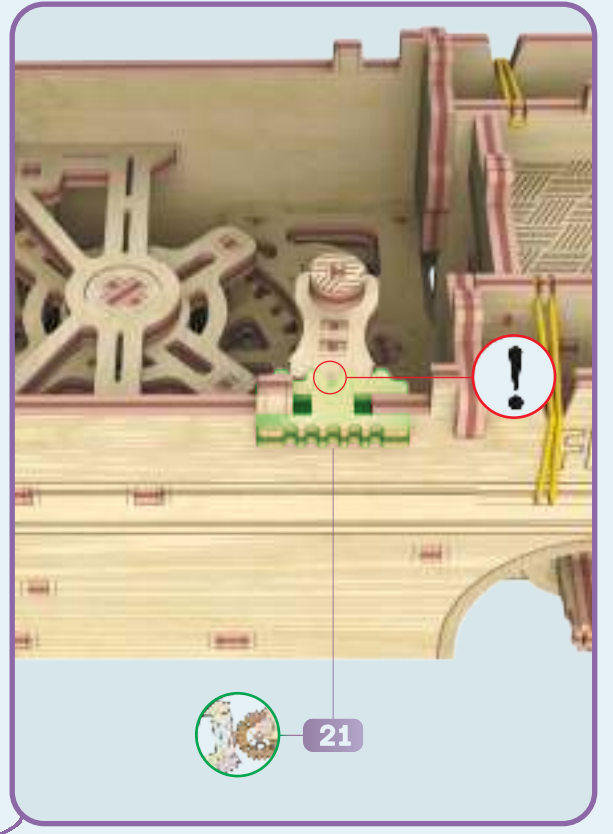
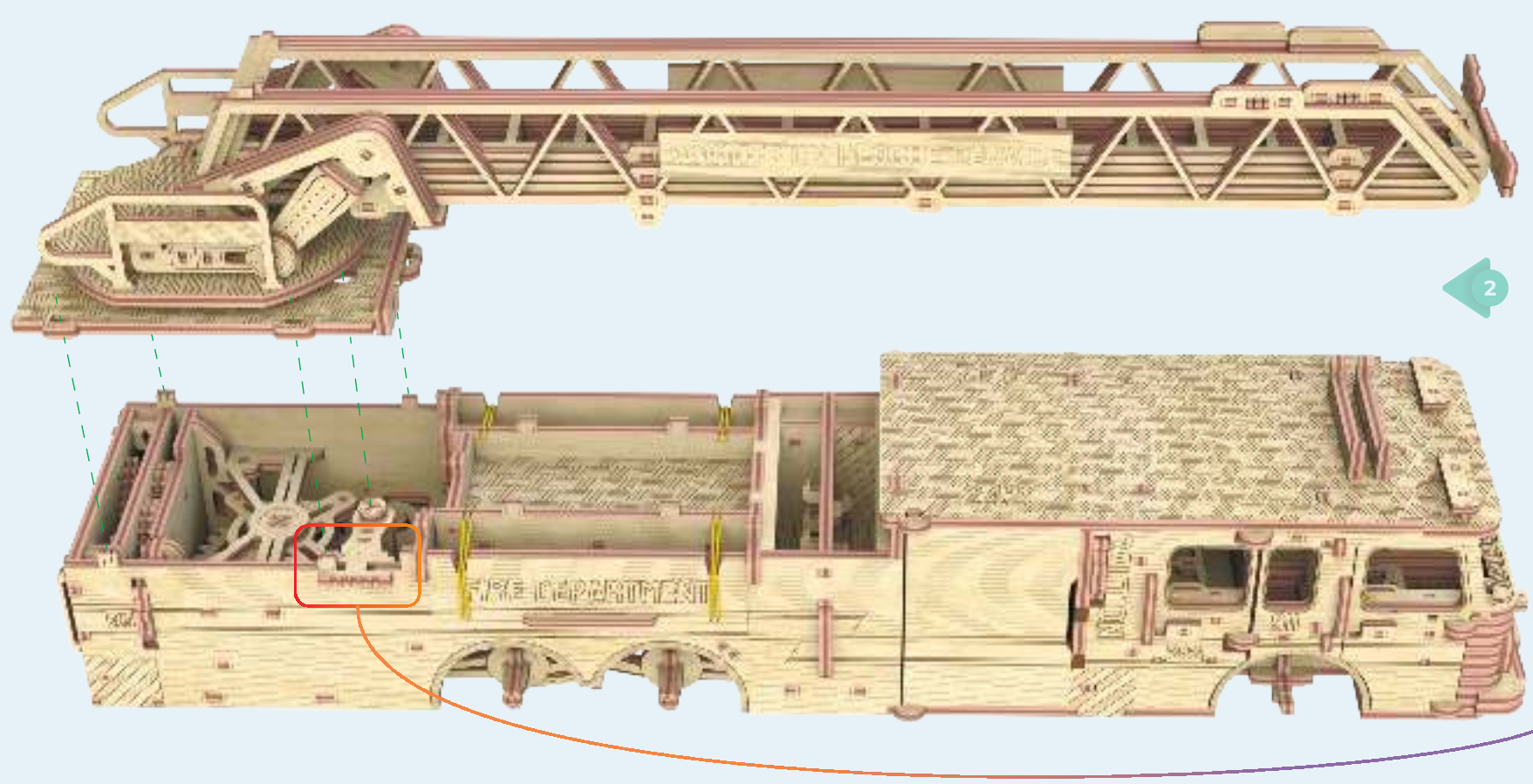
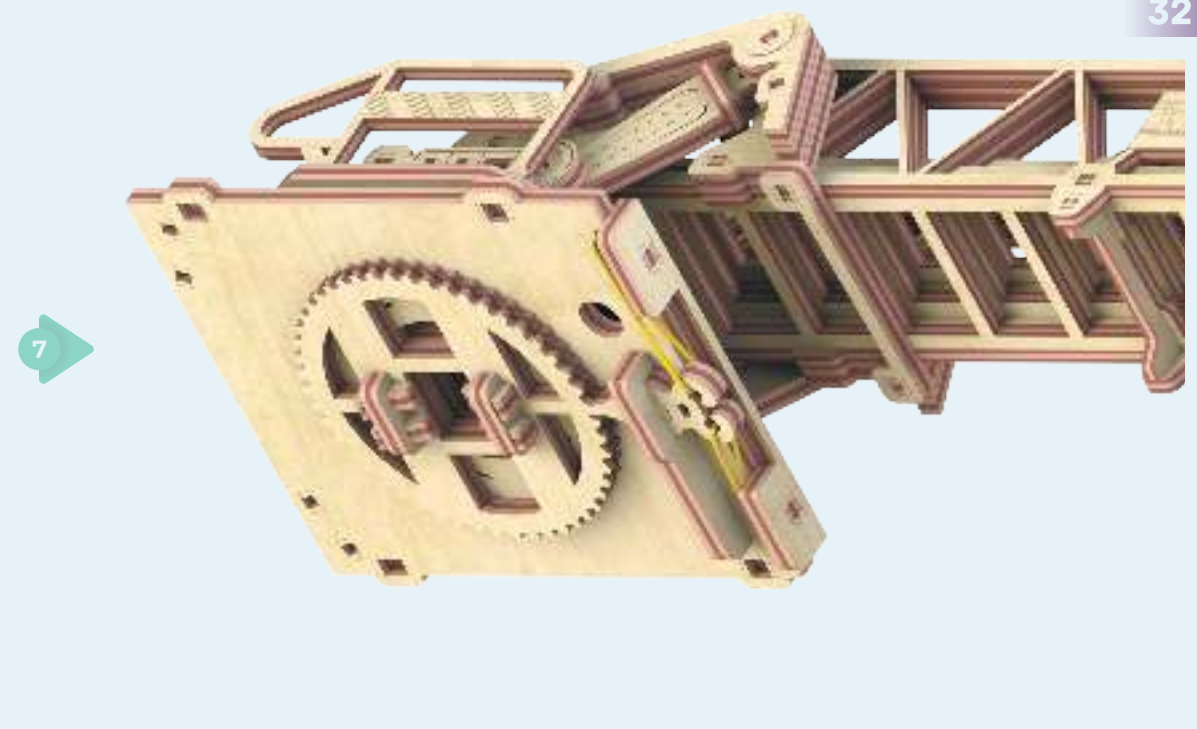
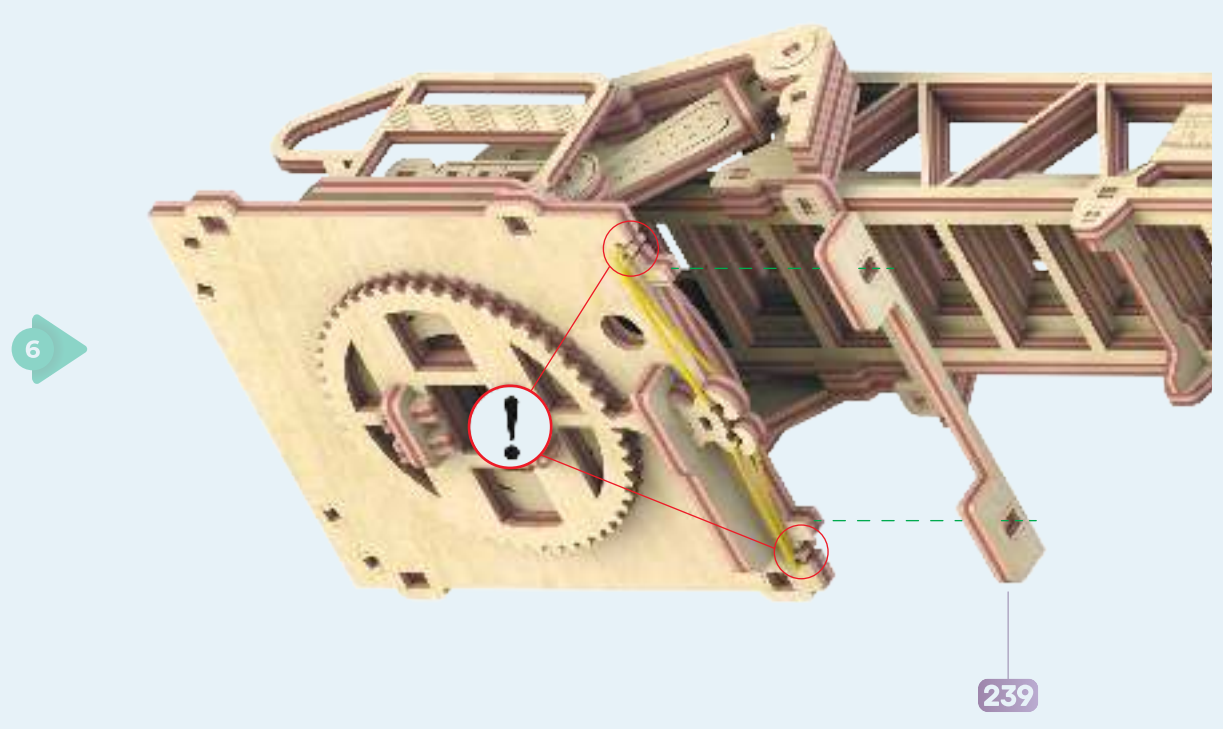

1

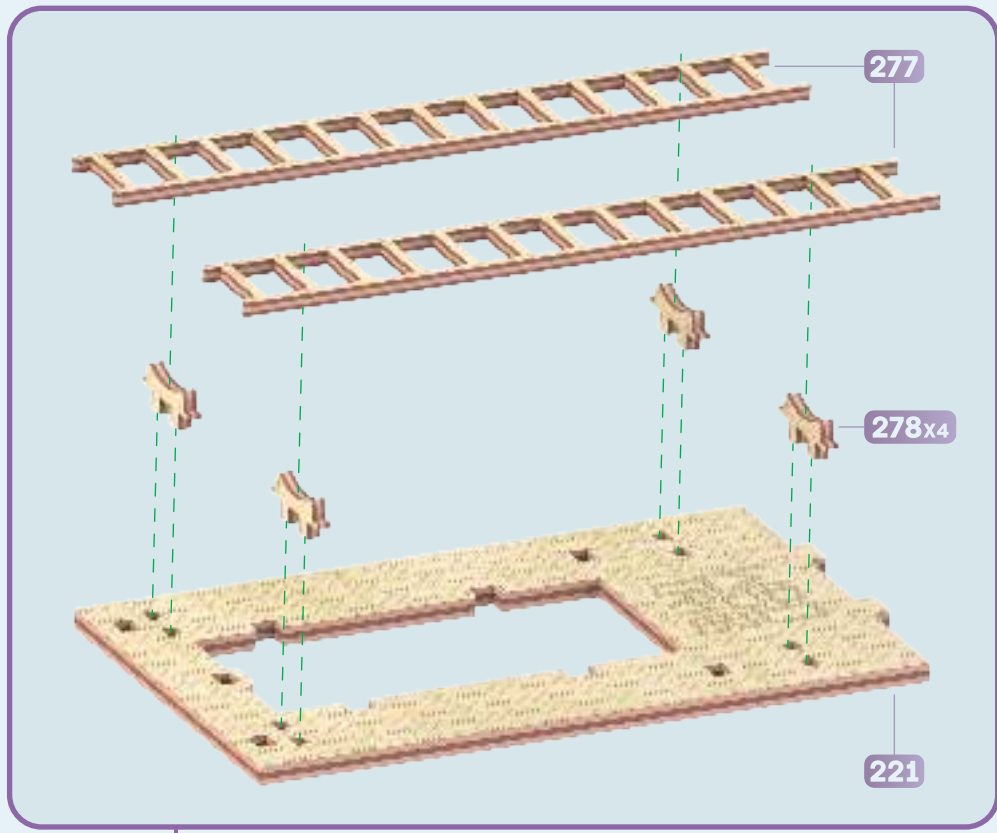

2

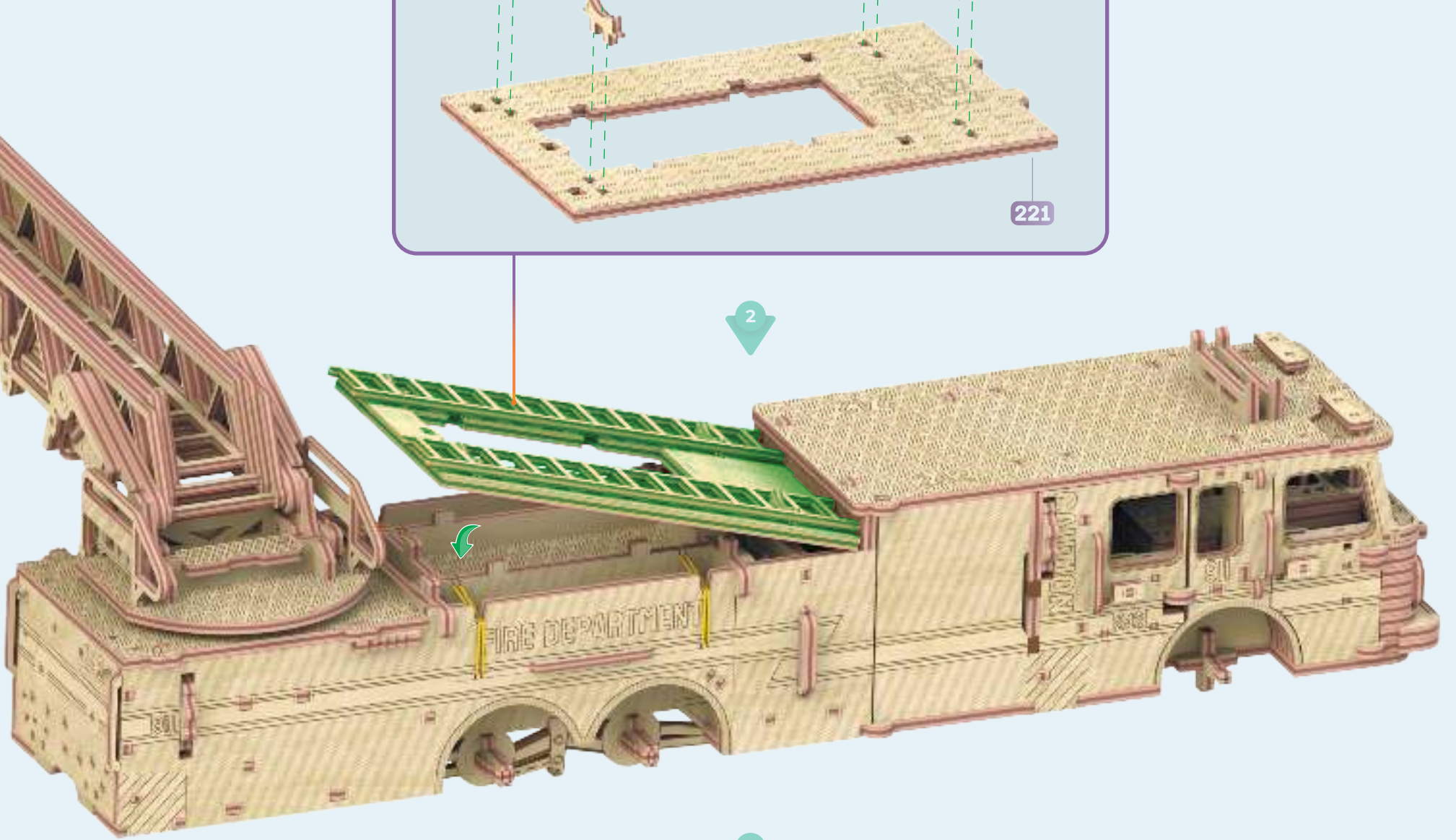

3

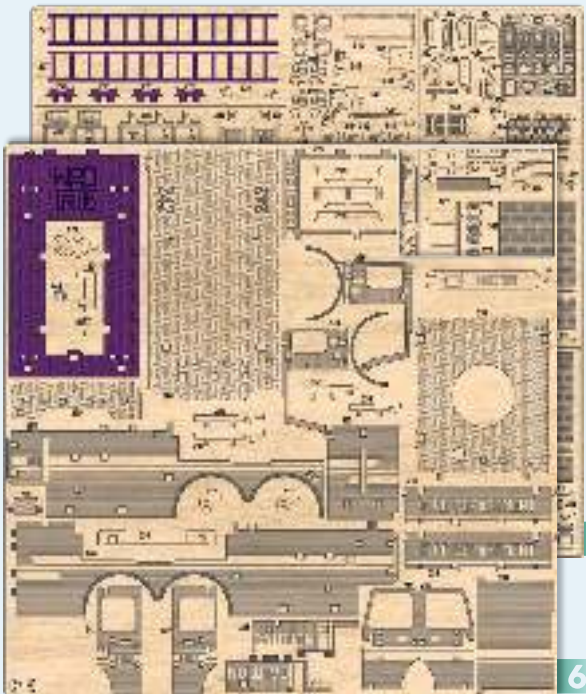
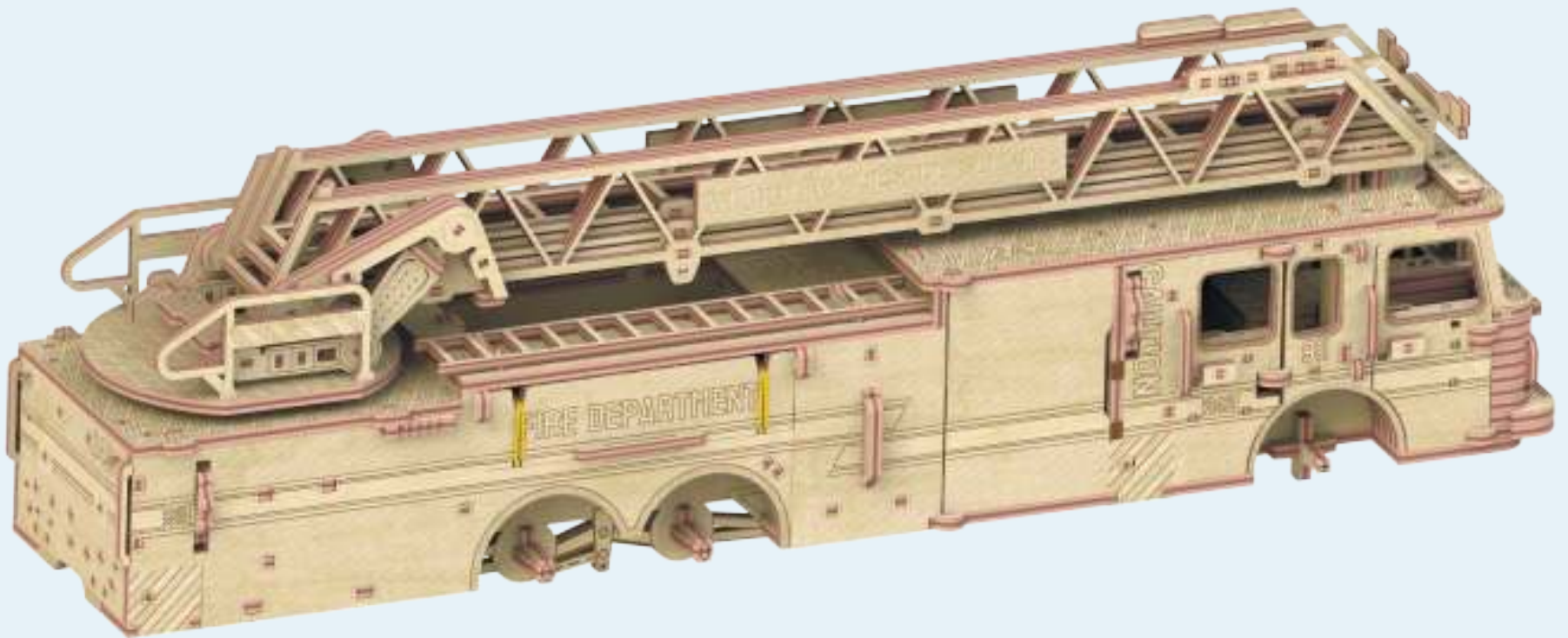

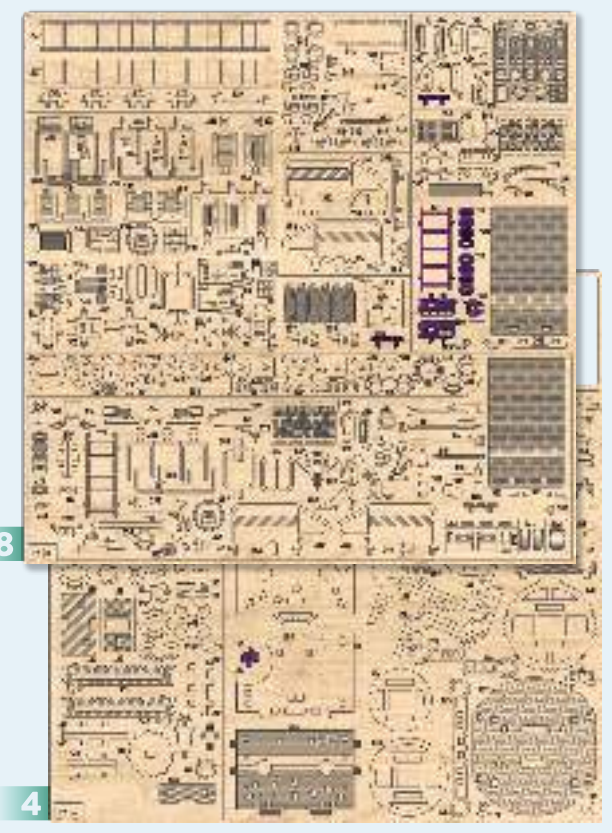
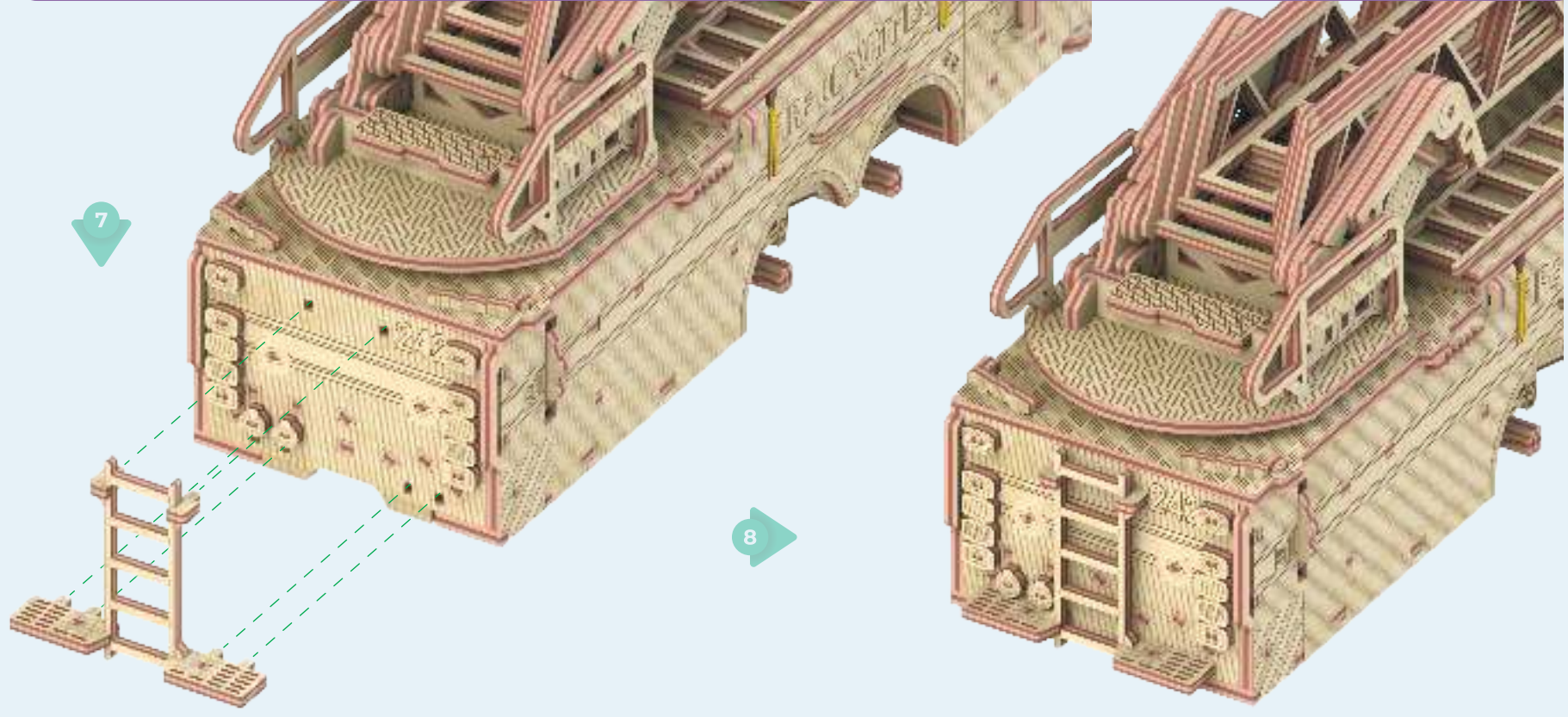
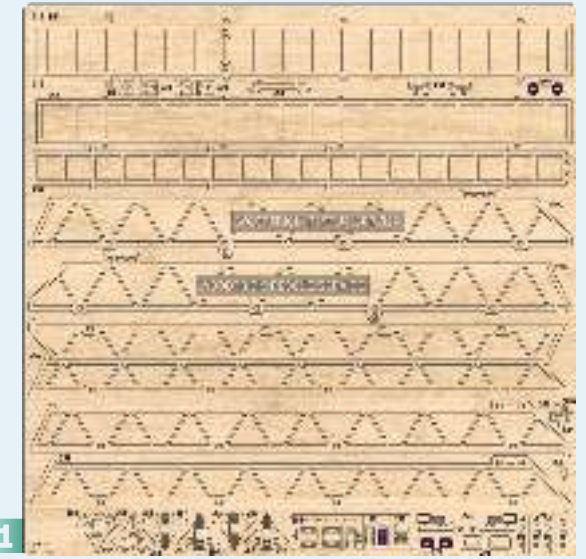
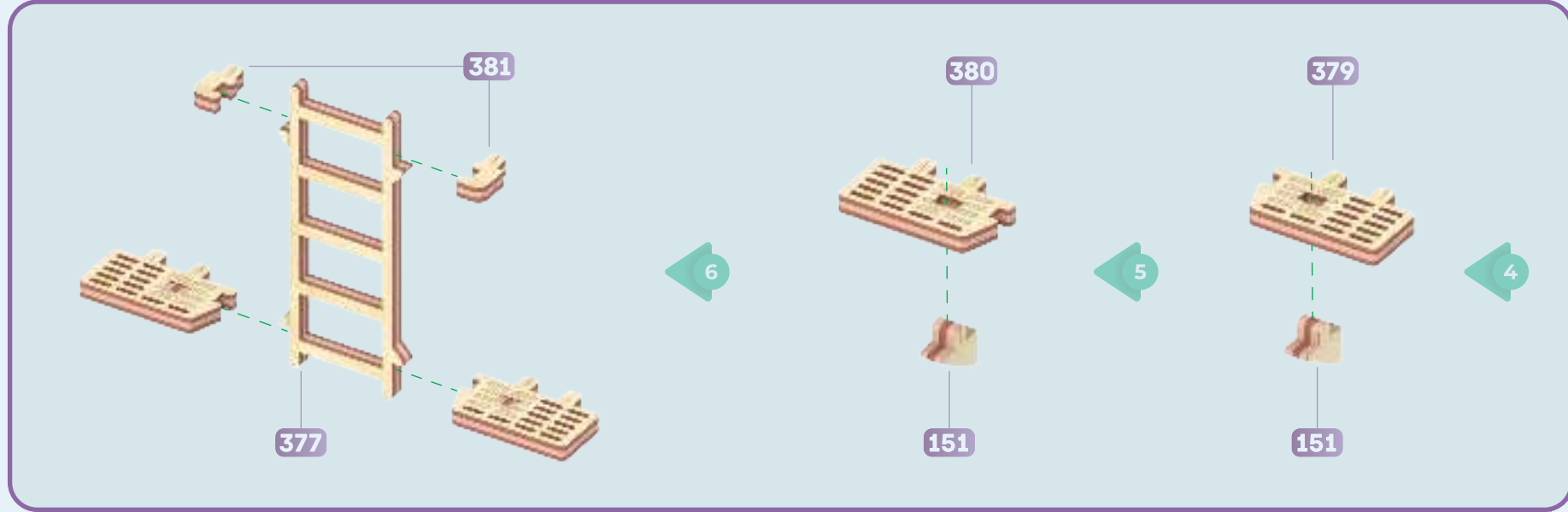
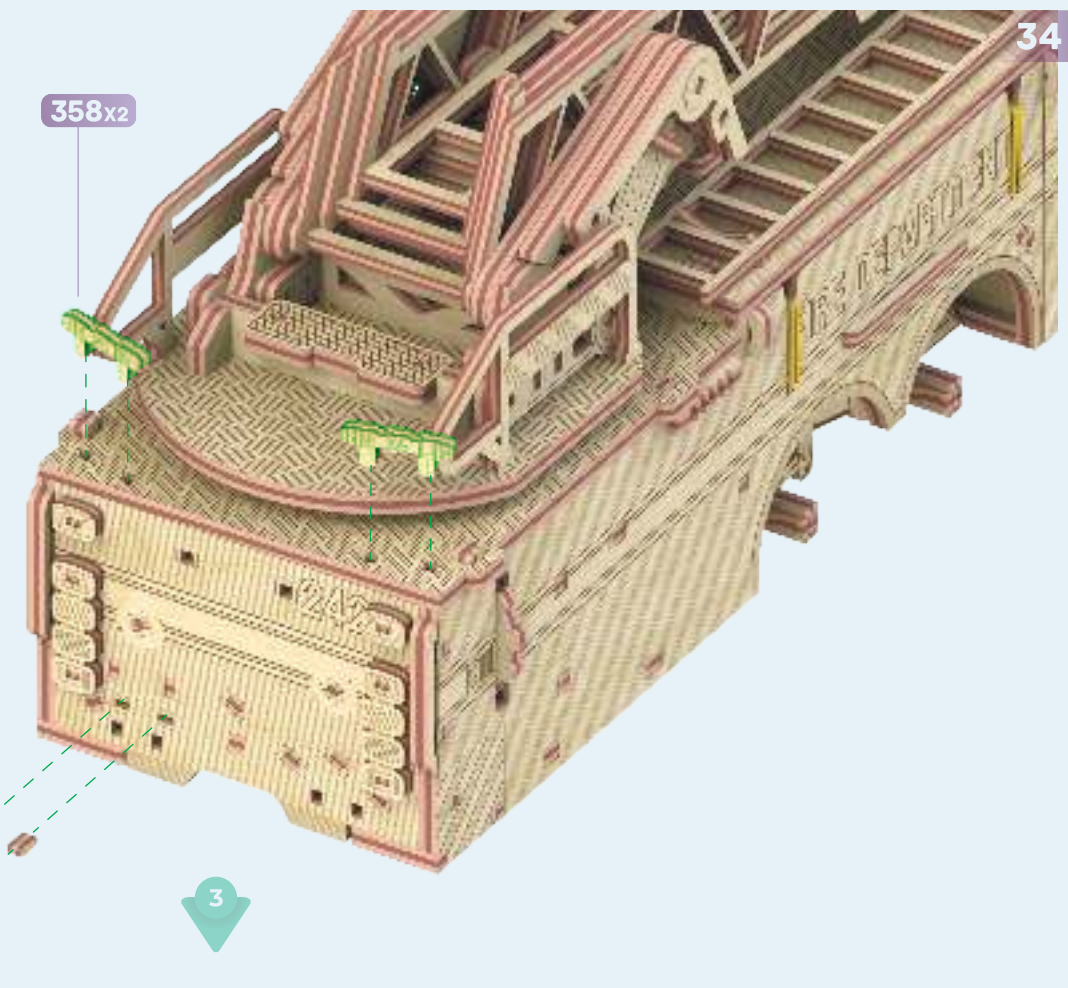
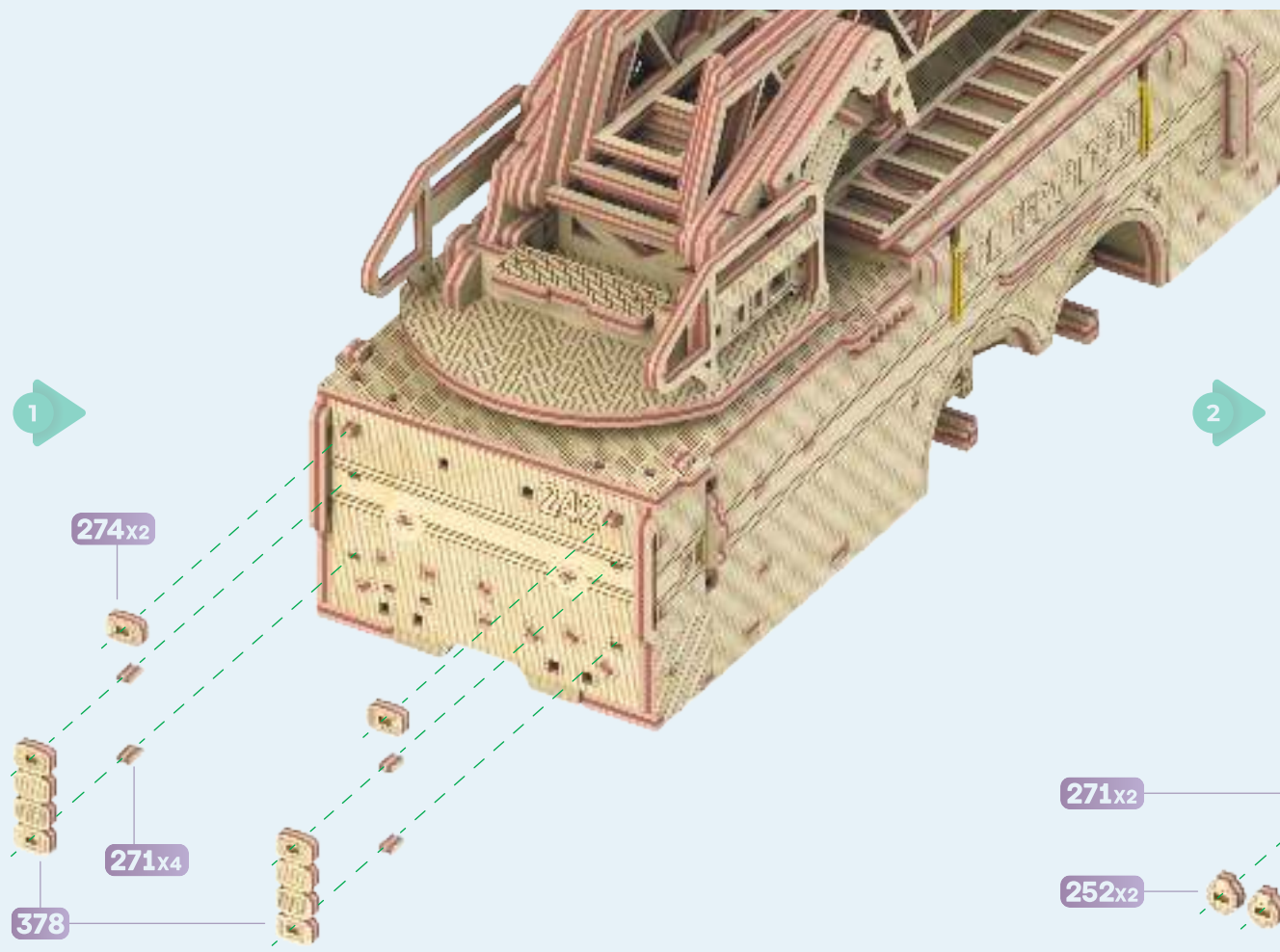

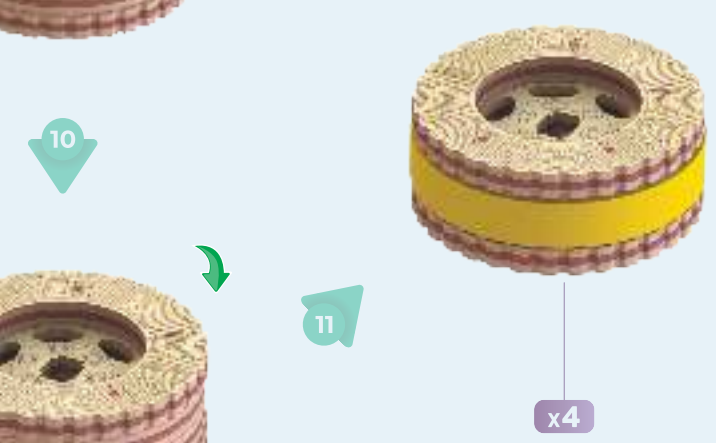
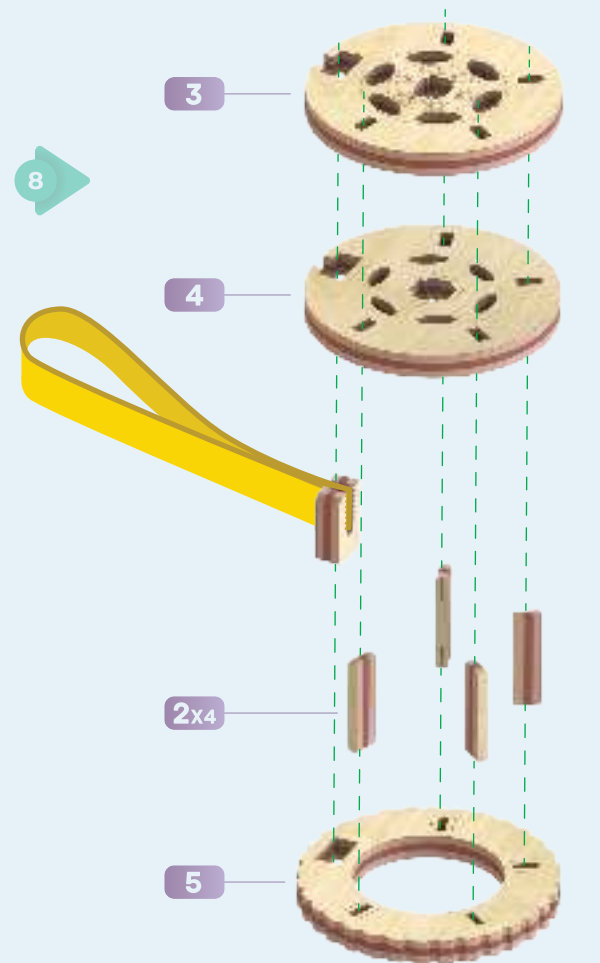
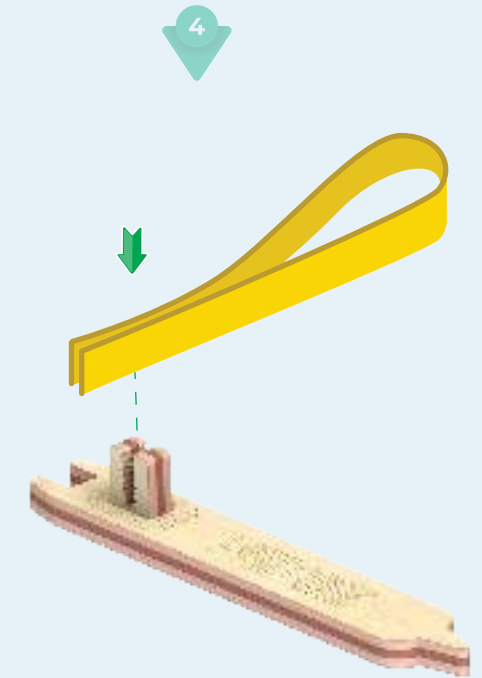
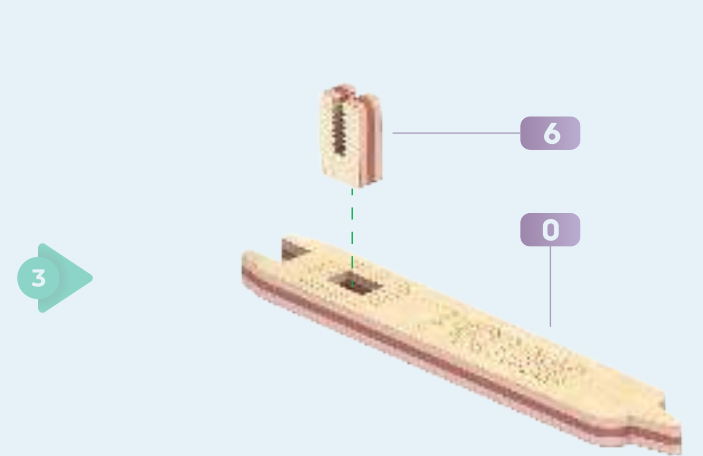
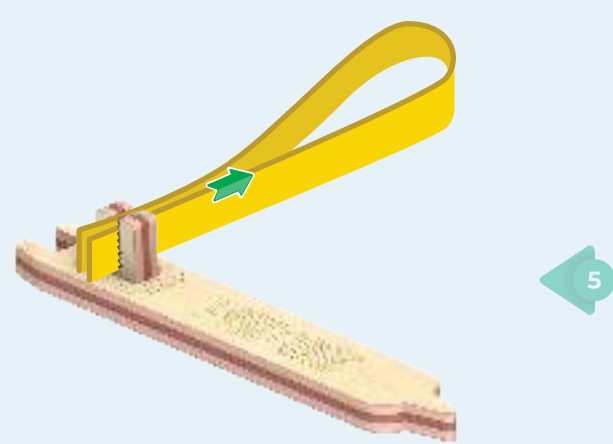
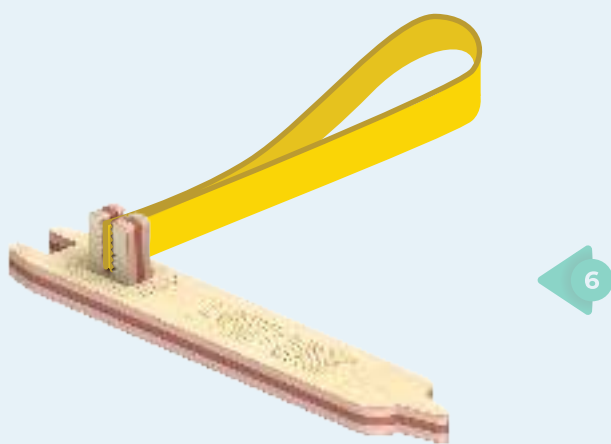
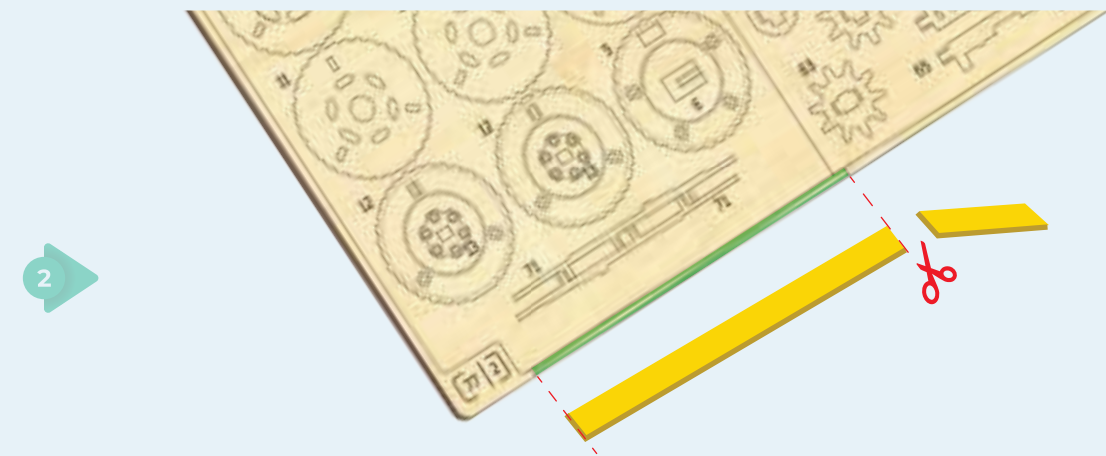
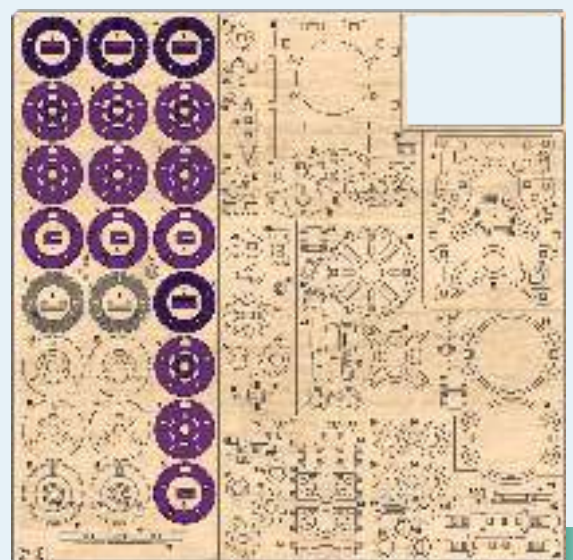
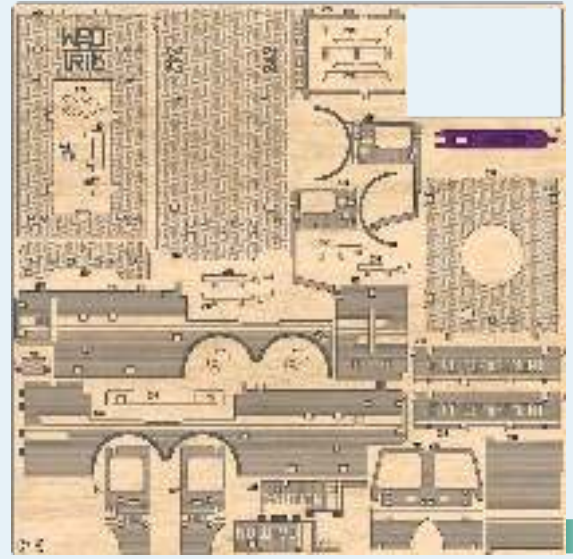
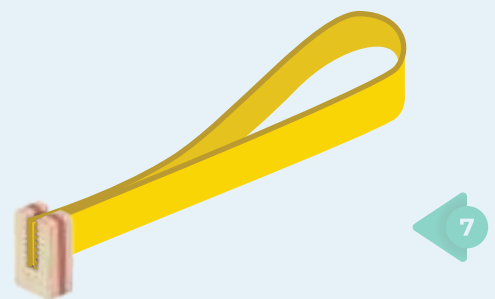
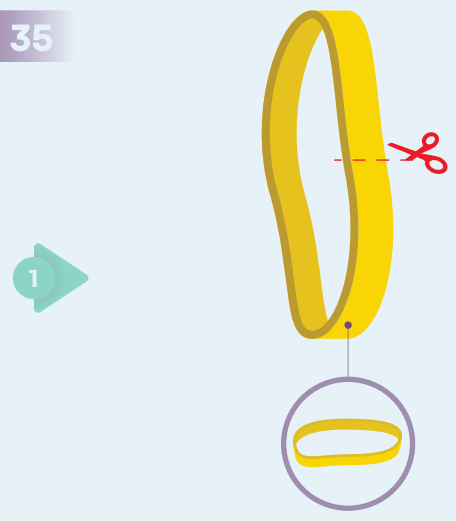

x4

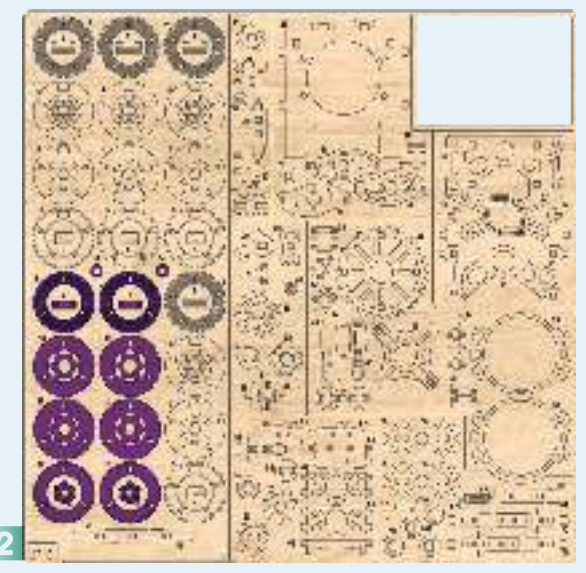
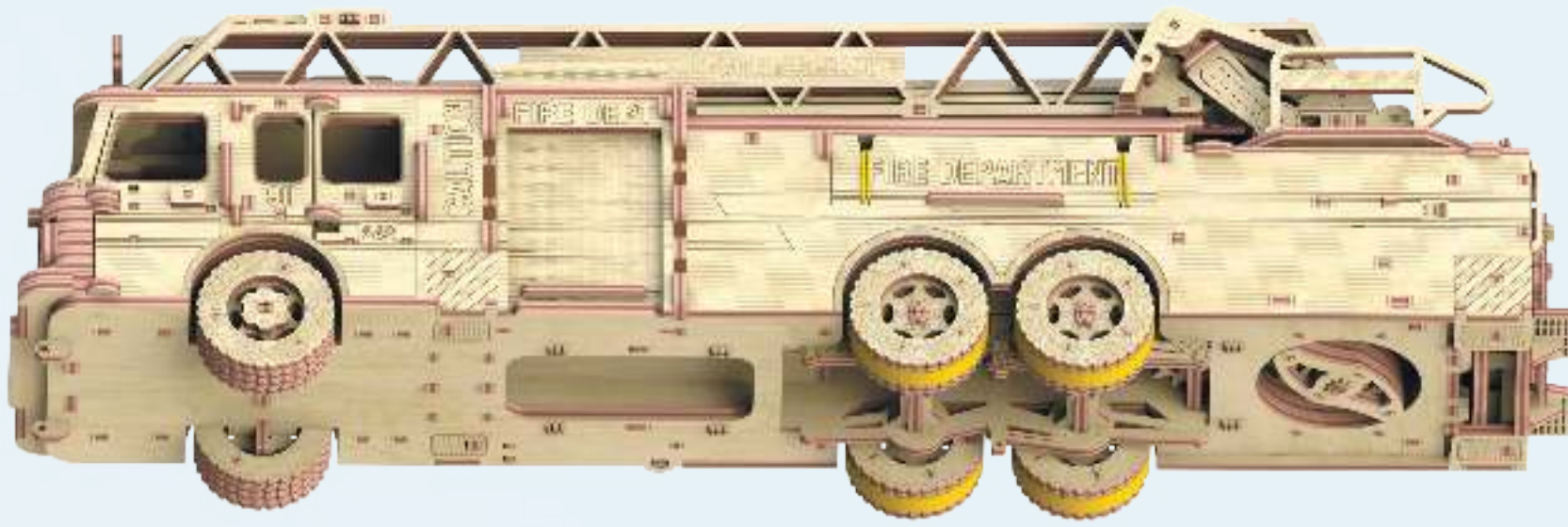
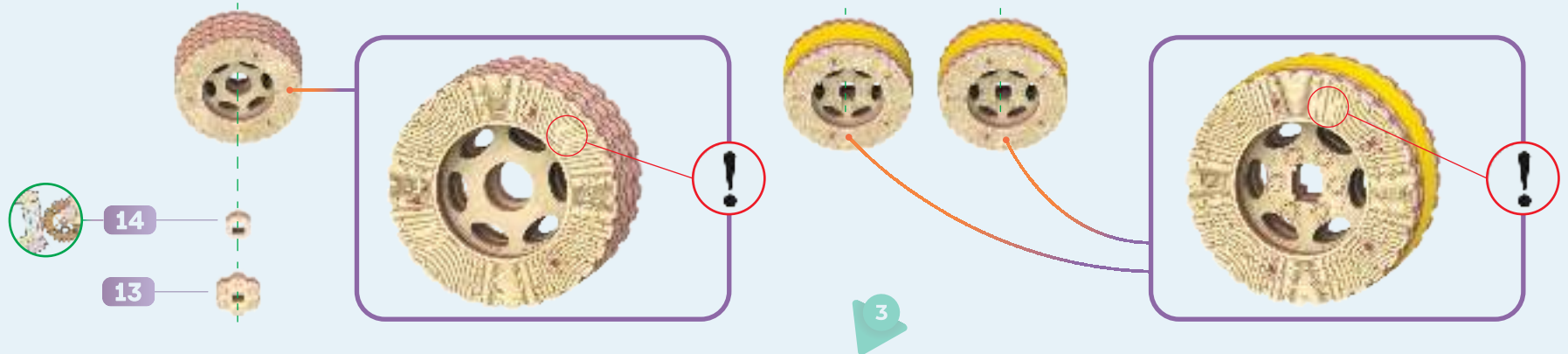
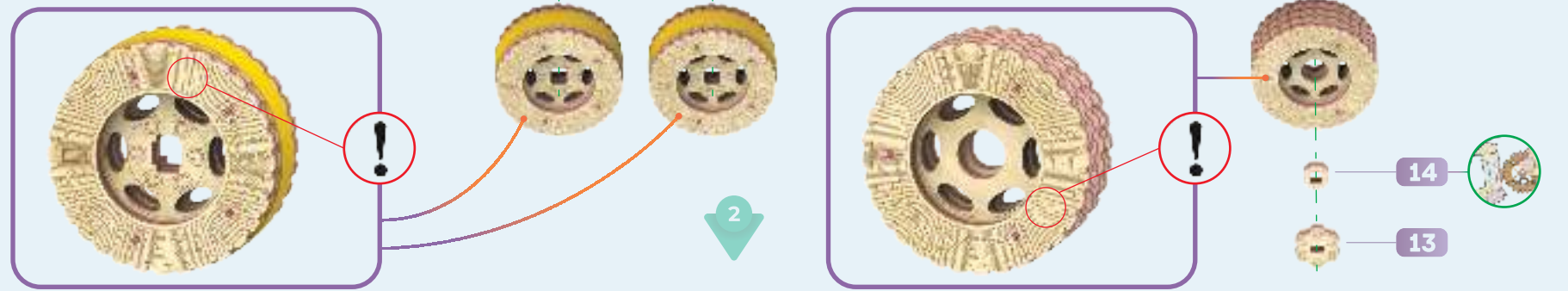
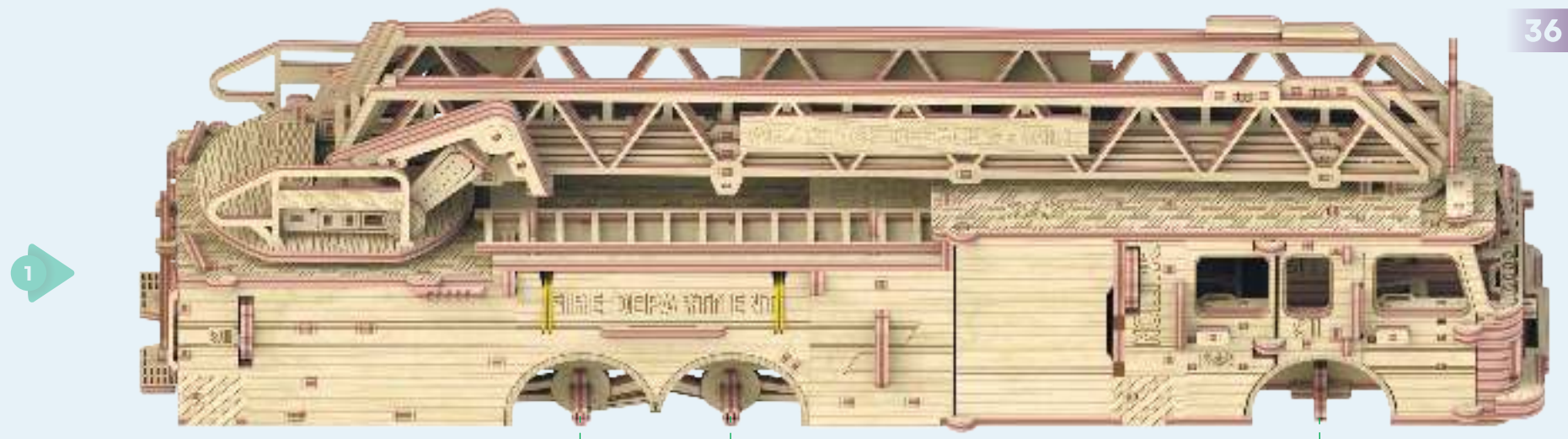
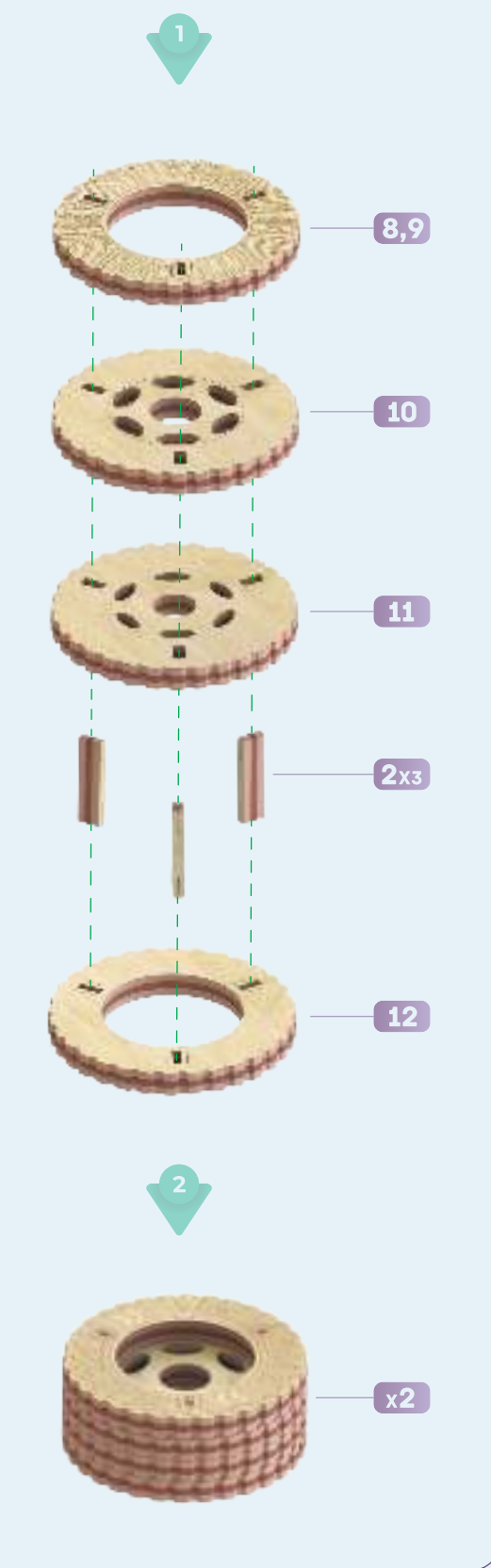

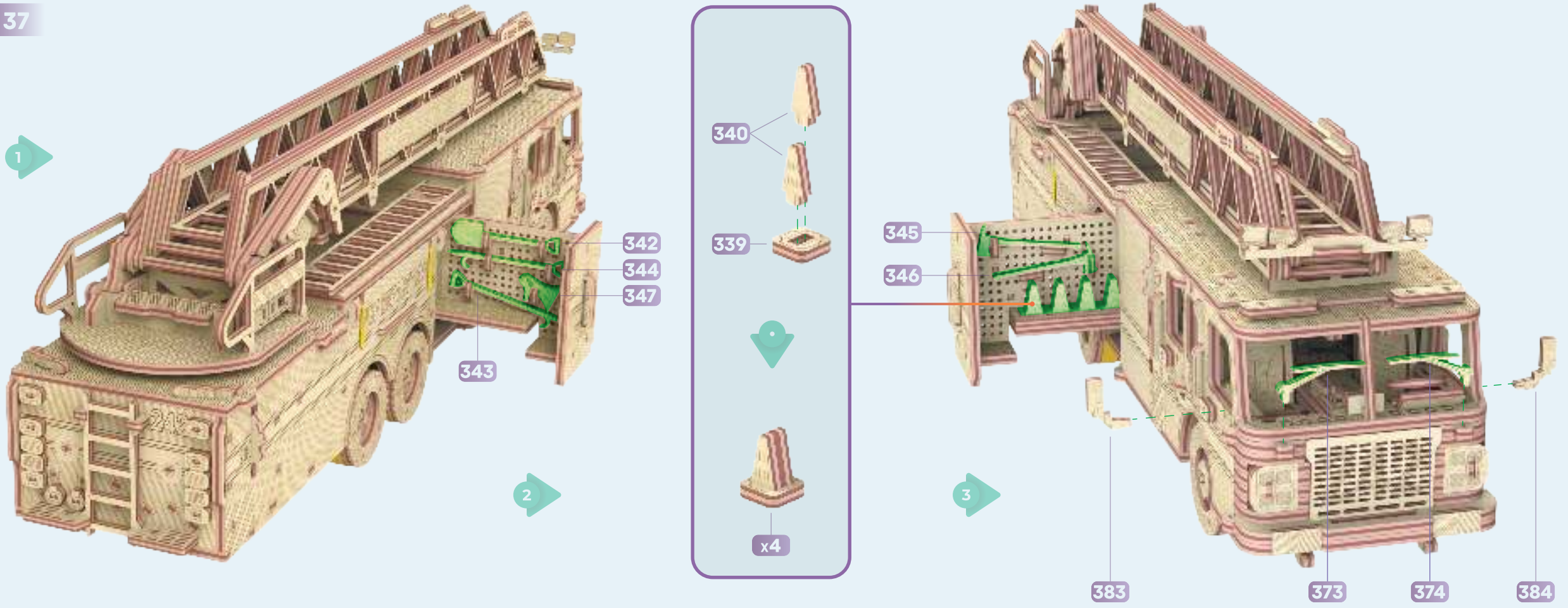

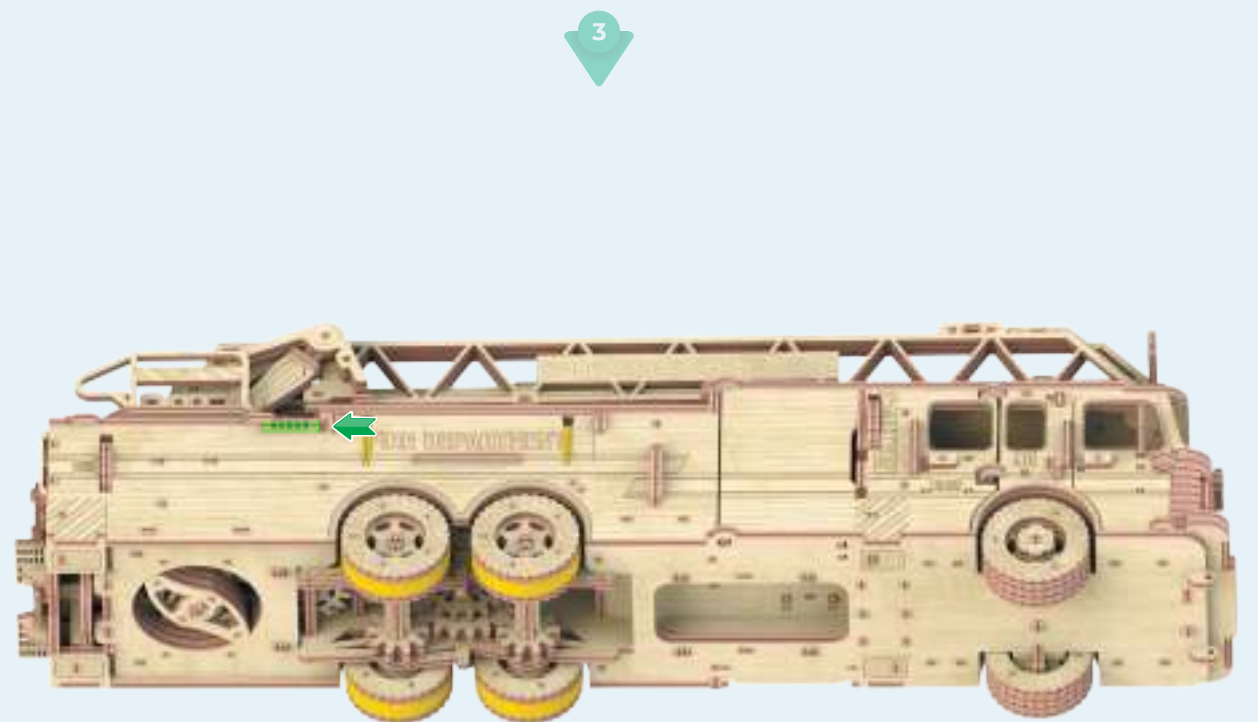
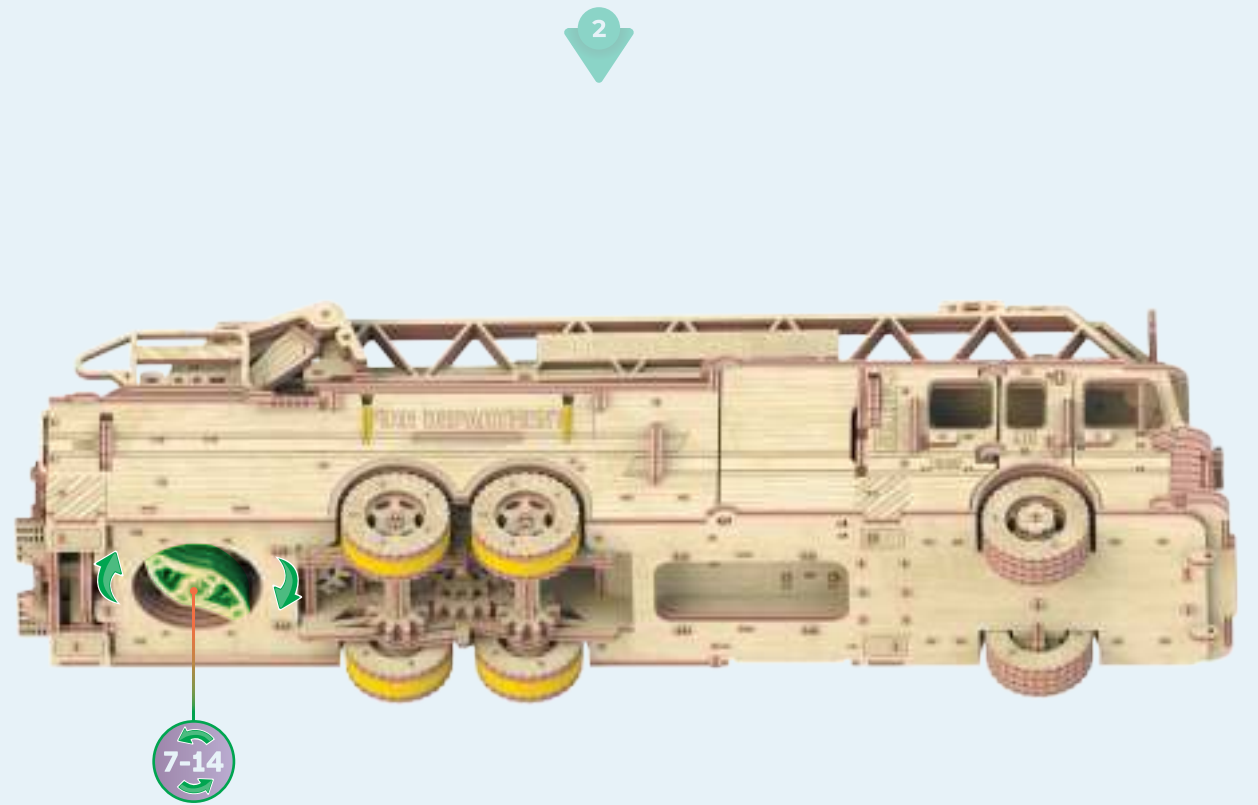
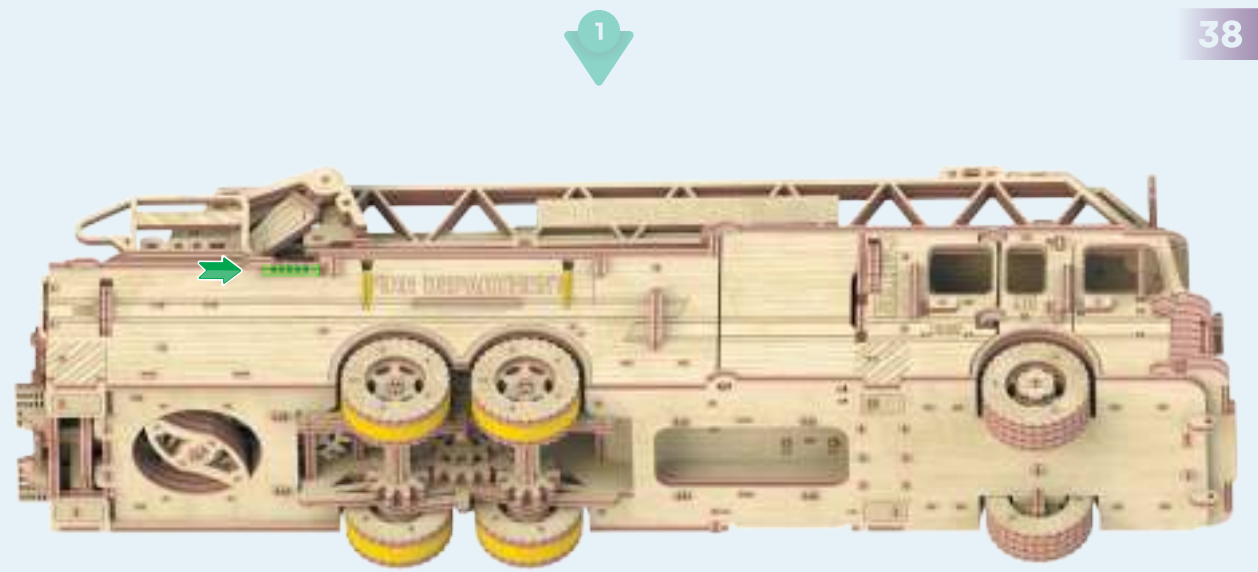

WOODTRICK

HOW TO REPLACE A BROKEN PART

Sometimes it happens that a part of the WoodTrick model is lost or damaged.

But you have nothing to worry about because we have the replacement service. This option is free and quick, and you can easily use it for missed or damaged parts of your WoodTrick constructor.

MAKE THE REPLACEMENT IN 5 SIMPLE STEPS

STEP 1

Open the Replacement form on our website woodtrick.com.

Or you can scan the QR code, which will redirect you to the replacement page.



STEP 2

Indicate the reason for replacement.

There is no need to attach the photo or video of the broken part, it's enough to choose the reason in the list.

STEP 3

Mention the name or the set number of the WoodTrick model with the missing part.

Name: RESCUE FIRETRUCK
Set number: WDTK091

STEP 4

Choose the board* which contains the part you need.

**All parts and all boards have the numbers. For the replacement you'll need to mention the N° of the board. To find the correct board, use the assembly instruction.*

STEP 5

Fill the delivery address and it's done!

FREE REPLACEMENT

For each WoodTrick model we provide 2 (two) free replacements. We always send the full board to avoid the risks of damaging a small part during the delivery. For example, if you need part 14 which belongs to Board 1, we will send the whole Board 1.

NEED SOME HELP?

In case you faced any difficulties with the replacement please contact us: support@woodtrick.com. Our support team is available 24/7 and will assist with the issue. You can also get the consultation from support for any questions about assembly.